



Westinghouse

**USER'S MANUAL**  
*MANUEL DE L'UTILISATEUR*  
*MANUAL DEL USUARIO*

---

**SK-26H590D**

**SK-32H590D**

Widescreen DVD Combo

*Combo Lecteur à Écran Géant*

*Combo DVD Pantalla Grande*

# INDEX

---

<b>IMPORTANT INFORMATION</b> .....	<b>2</b>
1. WARNING.....	2
2. SAFETY GUIDELINES.....	3
3. IMPORTANT SAFETY INSTRUCTIONS.....	4
4. ANTENNA INSTALLATION SAFETY.....	6
5. CLEANING THE LCD TV.....	6
6. DISC.....	7
<b>PREPARATION</b> .....	<b>9</b>
1. PACKAGE CONTENTS.....	9
2. TV CONTROLS.....	10
3. TERMINALS.....	11
4. REMOTE CONTROL.....	12
<b>INSTALLATION</b> .....	<b>14</b>
1. INSERT BATTERIES IN THE REMOTE CONTROL.....	14
2. ANTENNA CONNECTION.....	15
3. EXTERNAL DEVICE CONNECTIONS.....	16
4. POWER CONNECTION.....	18
5. INITIAL SETUP.....	18
<b>BASIC OPERATION</b> .....	<b>21</b>
1. TURNING ON AND OFF THE POWER.....	21
2. SOUND VOLUME.....	21
3. CHANGING CHANNELS.....	22
4. INPUT SELECTION.....	22
5. SELECTING MENU ITEMS.....	23
<b>MENU OPERATION</b> .....	<b>24</b>
1. VIDEO.....	25
2. AUDIO.....	29
3. CHANNELS.....	33
4. LOCKS.....	37
5. SETTINGS.....	42
6. ADVANCED.....	52
<b>PLAY DISC</b> .....	<b>56</b>
1. PLAYBACK PROCEDURE.....	56
2. SPECIAL PLAYBACK.....	57
3. DVD SETTINGS.....	58
<b>MP3/WMA/JPEG CD Playback</b> .....	<b>59</b>
1. MP3/WMA/JPEG CD information.....	59
2. MP3/MWA CD playback.....	60
3. JPEG CD playback.....	60
<b>SPECIFICATIONS</b> .....	<b>61</b>
<b>TROUBLESHOOTING</b> .....	<b>63</b>
<b>APPENDIX</b> .....	<b>64</b>
APPENDIX A: Remove the base.....	64

# IMPORTANT INFORMATION

---

## 1. WARNING

**WARNING : TO REDUCE THE RISK OF FIRE OR ELECTRIC SHOCK, DO NOT EXPOSE THIS PRODUCT TO RAIN OR MOISTURE.**



**CAUTION**  
RISK OF ELECTRIC SHOCK  
DO NOT OPEN



**CAUTION: TO REDUCE THE RISK OF ELECTRIC SHOCK,  
DO NOT REMOVE COVER (OR BACK).  
NO USER-SERVICEABLE PARTS INSIDE.  
REFER SERVICING TO QUALIFIED SERVICE  
PERSONNEL.**



The lightning flash with arrow-head symbol, within an equilateral triangle, is intended to alert the user to the presence of uninsulated "dangerous voltage" within the product's enclosure that may be of sufficient magnitude to constitute a risk of electric shock to persons.



The exclamation point within a triangle is intended to alert the user to the presence of important operating and maintenance (servicing) instructions in the literature accompanying the product.



# IMPORTANT INFORMATION

---

## 3. IMPORTANT SAFETY INSTRUCTIONS

Follow and obey all warnings and instructions marked on the LCD TV. For your safety, please read all the safety and operating instructions before you operate the LCD TV. Keep this user's manual for future reference.

- (1) Read these instructions.
- (2) Keep these instructions.
- (3) Heed all warnings.
- (4) Follow all instructions.
- (5) Do not use the LCD TV near water.
- (6) Clean only with a dry cloth.
- (7) Do not block any ventilation openings. Install in accordance with the manufacturer's instructions.
- (8) Do not install near any heat sources such as radiators, heat registers, stoves, or other apparatus (including amplifiers) that produce heat.
- (9) Do not attempt to bypass the safety purpose of the polarized or grounding-type plug. A polarized plug has two blades with one wider than the other. A grounding-type plug has two blades and a third grounding prong. If the provided plug does not fit into your wall outlet, consult an electrician for replacement of the obsolete outlet.
- (10) Protect the power cord from being walked on or pinched particularly at the ends of the cord.
- (11) Only use attachments/accessories specified by the manufacturer.
- (12) Use only with the cart, stand, tripod, bracket, or table specified by the manufacturer, or sold with the LCD TV. When a cart is used, use caution when moving the cart to avoid injury or damage.



- (13) Unplug the LCD TV during lightning storms or when it is not being used for a long period of time.
- (14) Refer all servicing to qualified service personnel. Servicing is required when the LCD TV has been damaged in any way, such as the power-supply cord or plug is damaged, liquid has been spilled or objects have fallen into the LCD TV, it has been exposed to rain or moisture, it does not operate normally, or the TV has been dropped.
- (15) DISC SLOT – Keep your fingers well clear of the disc slot as it is closing. It may cause serious personal injury.
- (16) LASER BEAM – Do not look into the opening of the disc slot or ventilation opening of the product to see the source of the laser beam. It may cause sight damage.
- (17) DISC – Do not use a cracked, deformed, or repaired disc. These discs are easily broken and may cause serious personal injury and product malfunction.

### •Overloading

Do not overload wall outlets, extension cords, or power strips. This can result in fire or electronic shock.

### •Power Cord Protection

Power supply cords should be routed so that they are not likely to be walked on or pinched by items placed upon or against them. Periodically inspect the cords and each end of the cords for damage. The LCD TV shall be installed a near the wall socket outlet and the plug on power cord shall be readily accessible.

### •Ventilation

The slots and openings on the cabinet are provided for necessary ventilation. To ensure reliable operation of the LCD TV and to protect it from overheating, these slots and openings must never be blocked or covered.

# IMPORTANT INFORMATION



•Never cover the slots and openings with a cloth or other materials.

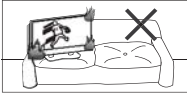

•Do not block the openings by placing the LCD TV on a bed, sofa, rug or other similar surface.

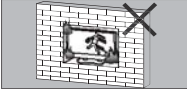

•Do not place the LCD TV in a built-in installation such as a bookcase or rack unless proper ventilation is provided or the manufacturer's instruction have been adhered to.

## •Other Notices

- Avoid exposing the LCD TV to direct sunlight or high temperatures.
- Avoid exposing the LCD TV to moisture or high humidity
- Do not attempt repairs yourself. Your warranty does not cover repairs or attempted repairs by anyone not authorized by Vivitek.
- If your LCD TV will not be used for a long period of time, unplug the LCD TV and remove the batteries from the remote control.

## •Precautions

- Avoid touching the screen by hand or any object.
  - Never remove the rear cover. Your LCD TV contains high-voltage parts. You may be seriously injured if you touch them.
  - Avoid exposing your LCD TV to direct sunlight or another heat source. Orient your LCD TV away from direct sunlight to reduce glare.
  - Always handle your LCD TV with care when moving it.
  - Place your LCD TV in a well-ventilated area; don't place the LCD TV in airtight compartments. Do not place anything on your LCD TV that prevents heat dissipation.
  - Ensure that the area around the LCD TV is clean and free of moisture.
  - Do not place heavy objects on the LCD TV, audio/video cables, or power cord.
  - If the LCD TV emits smoke, abnormal noise, or a strange odor, immediately turn it off and contact the Vivitek Service Center.
- **WARNING** – *The LCD TV shall not be exposed to dripping or splashing and objects filled with liquids, such as vases, shall not be placed on the TV.*
- **WARNING** – *Don't use hand or other things to touch the LCD screen.*

# IMPORTANT INFORMATION

## 4. ANTENNA INSTALLATION SAFETY

### •Outdoor Antenna Grounding

If an outside antenna or cable system is connected to the LCD TV, be sure the antenna or cable system is grounded to prevent voltage surges and built-up static charges. Article 810 of the National Electrical Code, ANS/NFPA 70, provides information on proper grounding of the mast and supporting structure, grounding of the lead-in wire to an antenna discharge unit, connection to grounding electrodes, and requirements for the grounding electrode.

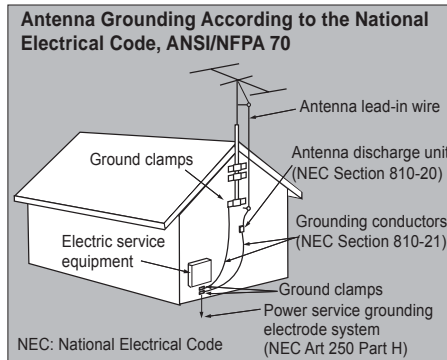

### •Lightning

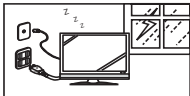

For added protection for the LCD TV during a lightning storm, or when it is left unattended and unused for long periods of time, unplug it from the wall outlet and disconnect the antenna or cable system. This will prevent damage to the LCD TV due to lightning and power-line surges.

### •Power Lines

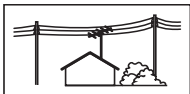

An outside antenna system should not be located in the vicinity of overhead power lines or other electric light or power circuits, or where it can fall into such power lines or circuits. When installing an outside antenna system, extreme care should be taken to keep from touching such power lines or circuits as contact with them might be fatal.

## 5. CLEANING THE LCD TV

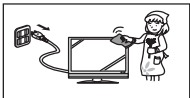

- MAKE SURE THE LCD TV IS TURNED OFF AND POWER CORD IS REMOVED.
- NEVER SPRAY OR POUR ANY LIQUID DIRECTLY ONTO THE SCREEN OR CASE.

### •To clean the screen:

1. Wipe the screen with a clean, soft, lint-free cloth. This removes dust and other particles.
2. If it still is not clean, apply a small amount of non-ammonia, non-alcohol based glass cleaner onto a clean, soft, lint-free cloth, and wipe the screen.

### •To clean the case:

1. Use a soft, dry cloth.
2. If it still is not clean, apply a small amount of non-ammonia, non-alcohol based, mild non-abrasive detergent onto a clean, soft, lint-free cloth, then wipe the surface.

## 6. DISC

### 6-1 On handling discs

- Be sure to hold the edge of disc. Do not touch the surface of the disc.
- Do not attach paper or tape to discs.

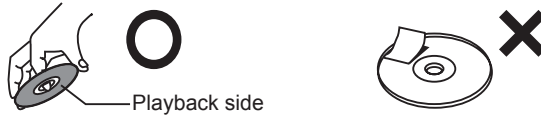

### 6-2 On cleaning discs

- Wipe the disc with a clean, dry cloth from the center outward toward the edges.
- Do not wipe the disc in a circular motion around the center.
- Do not use liquid or aerosol cleaners.



### 6-3 ON storing discs

- Store the disc in the case to avoid any risk of scratches, dirt or damage.
- Do not leave the disc exposed to direct sunlight or in hot or humid places.

### 6-4 Playable discs

In this unit, use only discs that meet the standard, such as DVD-Video, DVD-R/RW (Video format only), Audio CD, CD-R/CD-RW (CD-DA, MP3, WMA or jpeg format). If you use a non-standard disc, we cannot guarantee playback. Even if such a disc can be played back, we cannot guarantee the image or sound quality.

- This unit is designed to playback music Compact Discs (CD) that conform to the CD standard. CDs that contain (copy-restriction) signals to protect copyrights cannot be played back.
- Some CD-R/RWs and DVD-R/RW cannot be played back depending on the recording conditions.
- **When you play an 8 cm disc, you need the adapter (not supplied).**



# IMPORTANT INFORMATION

## 6-5 Region management information

The region number of this unit is 1. If region numbers, which stand for their playable area, are printed on your DVD video disc and you do not find " 1 " or " ALL " , disc playback will not be allowed by the player. (In this case, the unit will display a message on-screen.)

Some DVDs that have no region code label may still be subject to area restrictions and therefore not playable.

## 6-6 Structure of disc contents

Normally, DVD video discs are divided into titles, and the titles are sub-divided into chapters.

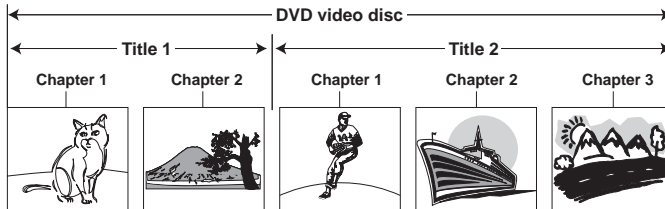

Video CDs and Audio CDs are divided into tracks.







Each title, chapter or track is assigned a number, which is called "title number", "chapter number" or "track number" respectively.

## 6-7 Notes on copyright

The unauthorized recording, use, distribution, or revision of copyrighted materials including, without limitation, television programs, videotapes, and DVDs, is prohibited under the Copyright Laws of the United States and other countries, and may subject you to civil and criminal liability

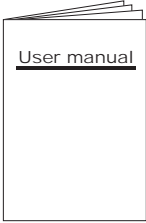
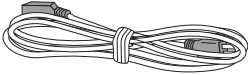
## 1. PACKAGE CONTENTS

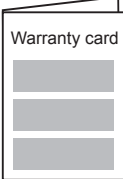
26"/32" LCD TV/DVD COMBINATION	Remote Control x1 (with 2 pcs AAA batteries)
	
User manual x1	Power cord x1
	
Quick Connect Guide x1	Warranty card x1
	

# PREPARATION

## 2. TV CONTROLS



1. MENU	Turn the Menu ON/OFF
2. VOL + / -	Adjust (VOL + / -) sound volume or adjust a highlighted control while in the Menu.
3. CH + / -	Adjust (CH + / -) channel when input is TV or adjust a highlight control while in the Menu.
4. INPUT	Select Active Video Input or choose a selection while in the MENU.
5. ▶	Play & Pause button, to play or pause
6. ◀◀	Backward: Press once for fast backward; Press and hold for Chapterbackward
7. ▶▶	Forward: Press once for fast forward; Press and hold for Chapterforward
8. ■/▲	Stop button. Press once to stop and remember last position; Press twice or more to stop and return to top menu after re-playing; Press and hold for 2 sec. to eject the disc.
9. ⏻	Power ON/OFF
10. •	AC Reset. When the TV Shuts down or the remote control doesn't work. You can push it with a needle.

## 3. TERMINALS

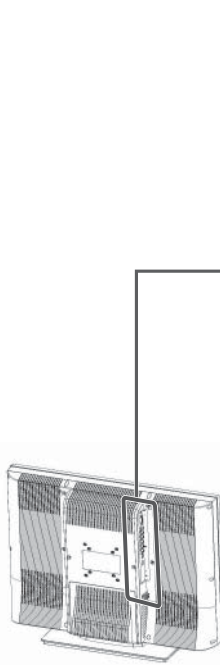

1	<b>1. VGA Audio IN</b> Connect to the Audio out (Green) from a computer.
2	<b>2. VGA</b> Using a 15-pin VGA cable, connect to a computer or other device with a VGA output.
3	<b>3. YPbPr1 Input</b> Connect an external video device with component output to these jacks.
4	<b>4. YPbPr2 Input</b> Connect an external video device with component output to these jacks.
5	<b>5. YPbPr1 Audio 1 Input (Left / Right)</b> Connect an external audio source to this jack.
6	<b>6. YPbPr2 Audio 2 Input (Left / Right)</b> Connect an external audio source to this jack.
7	<b>7. HDMI 1/2</b> Connect to an external video device such as DVD players, Game System, Cable, or Satellite boxes
8	<b>8. HDMI Audio Input (Right / Left)</b> Connect external analog audio to this jack
9	



10	<b>10. Video Input</b> Connect the Composite Video to an external video device such as VCR, DVD or video game system.
11	<b>11. S-Video Input</b> Connect to an external video device such as a digital cable/satellite receiver, VCR, DVD or video game system.
12	<b>12. Video &amp; S-Video Audio Input (Right / Left)</b> Connect an external audio source to this jack; (Audio (R/L)). This connection supports either S-Video or Video input.
13	<b>13. SPDIF Audio Output</b> Connect this output to an external digital audio receiver.
14	<b>14. Analog Audio Output (Right / Left)</b> Connect this output to an external audio receiver.
15	<b>15. ANT (RF-input)</b> Connect the LCD TV to an antenna or cable service. Such as NTSC, ATSC, or Cable.
16	

# PREPARATION

## 4. REMOTE CONTROL

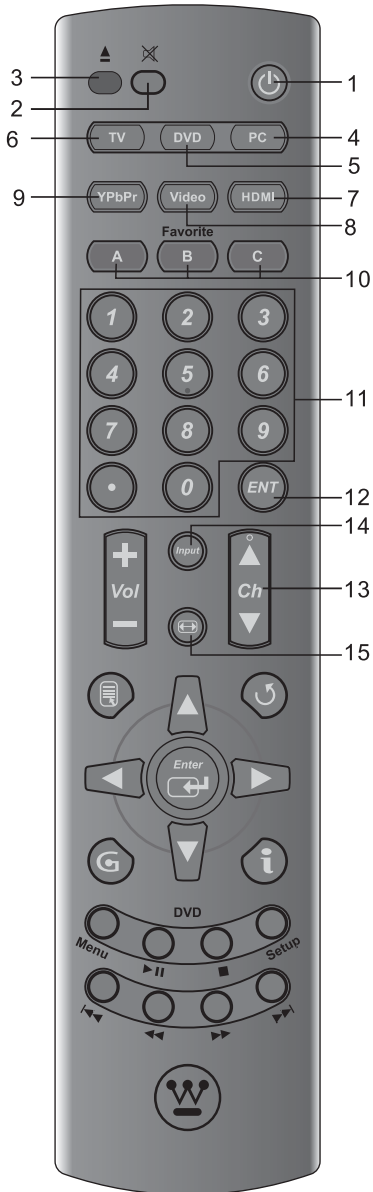

Remote Control	
1.POWER	Switch TV power On/Off.
2.Mute	Mutes the sound.
3.DVD Eject	Eject the DVD disc.
4.PC	Select VGA source input.
5.DVD	Select DVD source input.
6.TV	Select TV (NTSC/ATSC) source input.
7.HDMI	Select HDMI 1/HDMI 2 source input.
8.VIDEO	Select Video/S-video input.
9.YPbPr	Select YPbPr1/YPbPr2 source input.
10.Favorite	Select, remove or add your favorite channel.Press Favorite (A, B, C) key to access favorite list.Use arrow keys and enter key to select, add the channel from favorite list.(See more detail on page 35)
11.Channel number keys	Select specific channel.
12.Enter	Execute a command.
13.Ch ▲/▼	TV Channel Up/ Down adjustment.
14.Input	Select input source.
15.Aspect Ratio	Select Video Display format

►Note:  
Before setting up favorite channel, please make sure channel list is saved in TV. If not, perform channel scan to save a channel list in TV.

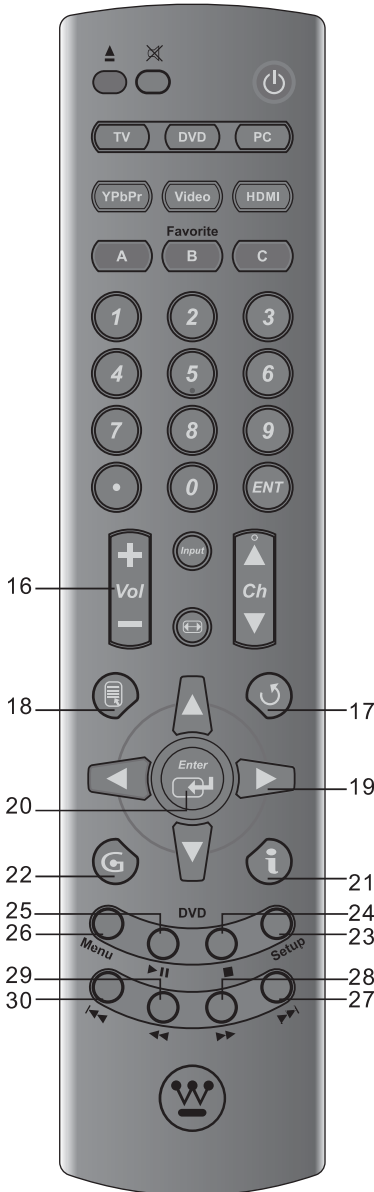

Remote Control	
16. Vol +/-	Volume Up / Down adjustment.
17. Last CH	Switch to previous channel.
18. Menu	Display the menu screen.
19. ▲/▼/◀/▶	Selects a desired item on the screen.
20. Enter	Execute a command.
21. INFO	Display the source and channel information..
23. DVD (Setup) button	Press when there is a disc in the player to open or close the setup screen.
24. ■(Stop)	Press to stop playback.
25. ►   (Play &Pause)	<ul style="list-style-type: none"> <li>●Play: Press to start or resume playback.</li> <li>●Pause: Press during playback to pause. Press again to resume playback.</li> </ul>
26. DVD Menu	Use to display or close the DVD menu screen.
27. ►► (Skip Forward)	Skip to the next chapter or tracks.
28. ►► (Fast-Forward) button	Press to perform fast-forward scanning.
29. ◀◀ (Fast-Reverse) button	Press to perform fast-reverse scanning.
30. ◀◀ (Skip Reverse) button	Skip to the previous chapter or tracks.

# INSTALLATION

---

## 1. INSERT BATTERIES IN THE REMOTE CONTROL

- (1) Remove the battery cover.
- (2) Insert the batteries corresponding to the (+) and (-) marks on the battery compartment.
- (3) Re-attach the battery cover.



### CAUTION:

- (1) Only use AAA batteries.
- (2) Do not mix new and old batteries. This may result in cracking or leakage, which may pose a fire risk or lead to personal injury.
- (3) Insert batteries according to (+) and (-) markings. Inserting the batteries incorrectly may result in cracking or leakage, which may pose a fire risk or lead to personal injury.
- (4) Dispose of used batteries in accordance with local laws and regulations.
- (5) Keep batteries away from children and pets.
- (6) When the remote control will not to be used for an extended period, remove the batteries.

### • TRANSMISSION RANGE OF REMOTE CONTROL

Transmission range depends upon the receive angle, the remote angle coverage is 25° Left/Right, 20° Up/Down from the LCD TV 20 Feet.

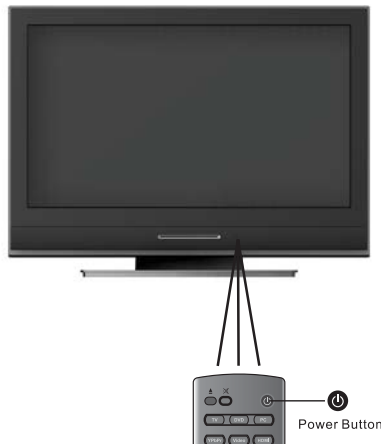

## 2. ANTENNA CONNECTION

### 2-1 Outdoor Antenna Connection

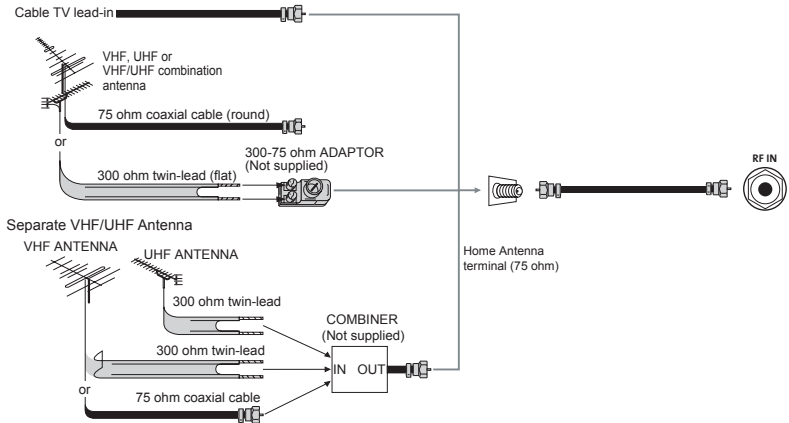

**► Notice:**

***F-type connector should be finger-tightened only.***

When connecting the RF cable to the TV set, do not tighten F-type connector with tools. If tools are used, it may cause damage to your TV set. (The breaking of internal circuit, etc.)

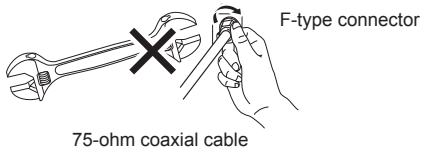

### 2-2 Cable TV (CTV/DTV) Connection

• A 75 ohm coaxial cable connector is built into the set for easy hookup. When connecting the 75 ohm coaxial cable to the set, screw the 75 ohm cable to the COAXIAL CABLE CONNECTOR.

• Some cable TV companies offer "premium pay channels". Since the signals of these premium pay channels are scrambled, a cable TV converter/ descrambler is generally provided to the subscriber by the cable TV company. This converter/ descrambler is necessary for normal viewing of the scrambled channels. (Set your TV on channel 3 or 4. Typically one of these channels is used. If channel is unknown, consult your cable TV company.) For more specific instructions on installing cable TV, consult your cable TV company. One possible method of utilizing the converter/ descrambler provided by your cable TV company is explained below.

"A" position on the RF switch (not supplied): You can view all unscrambled channels by using the TV's channel keys.

"B" position on the RF switch (not supplied): You can view the scrambled channels via the converter/ descrambler by using the converter's channel keys.

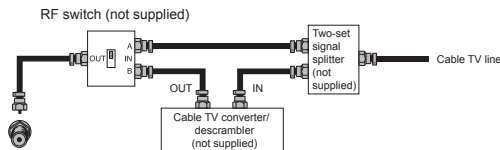



# INSTALLATION

## 3. EXTERNAL DEVICE CONNECTIONS

You can enjoy picture and sound by connecting a DVD or video game system to the terminals located on the rear of the LCD TV set.

When connecting an external device, turn off the power of the LCD TV set first to prevent any possible damage.

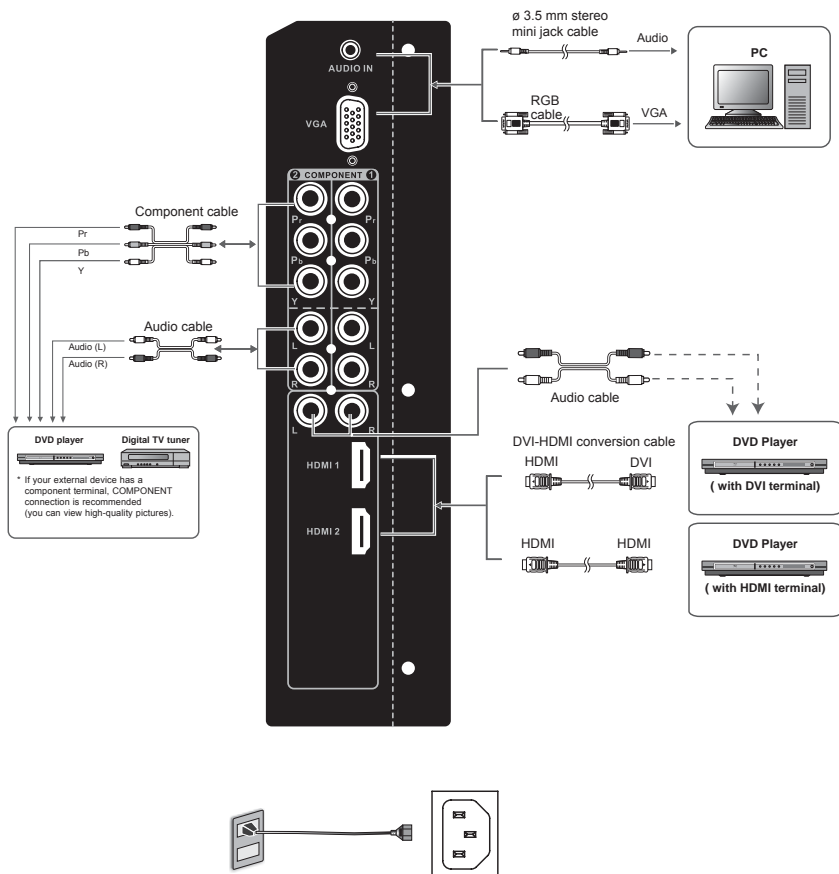

**Note: 100 ~130 VAC**

**IMPORTANT: Before connect, make sure all devices are turned off.**

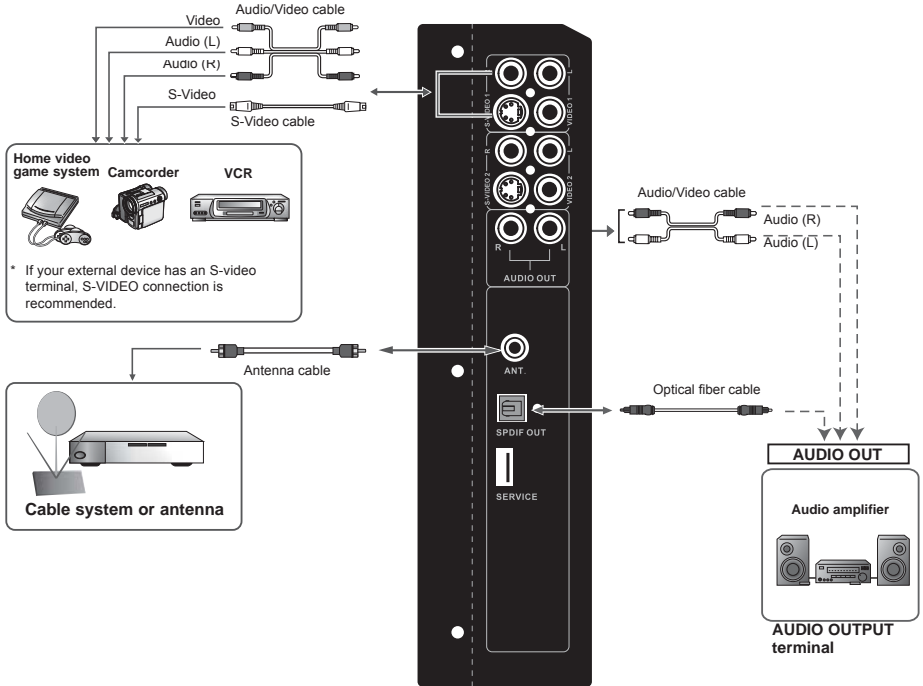

- For the cable, use a commercially available audio/video cable.
- For more information about external device connections, see the operation manuals of your external devices.
- Make sure that the corresponding cables are connected to each terminal. Connecting other cables may result in a malfunction.
- VIDEO and S-VIDEO terminals: If your external device has an S-VIDEO terminal, S-VIDEO connection is recommended. S-Video provides a finer, more detailed picture. If both terminals are connected, S-VIDEO terminal takes a priority.
- Component Input (YPbPr): Picture can be displayed only when 480i, 480P, 720P or 1080i signal is received.
- HDMI Input: Picture can be displayed only when 640×480, 480P, 720P or 1080i signal is received.
- When you connect to the HDMI terminal with the DVI-HDMI conversion cable, it may not be possible to display the picture correctly.
- This TV does not support DTS audio format. You may not hear proper audio output from TV speakers if choosing DTS audio format.

## Outputting Audio

You can output audio signals from the LCD TV set through the ANALOG AUDIO OUT terminals and the DIGITAL AUDIO OUT terminal.

# INSTALLATION

---

## 4. POWER CONNECTION

Connect the power cord to the DVD combo LCD TV then to a proper AC outlet.

**IMPORTANT:** The power input voltage is 120VAC, 60 Hz ONLY, Before beginning, make sure all devices are turned off.

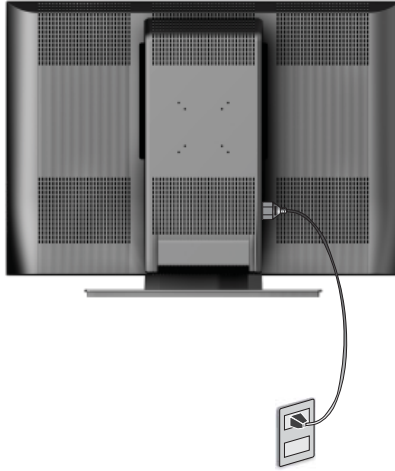

## 5. INITIAL SETUP

When you setup the LCD TV for the first time or Reset all on OSD menu is pressed, the Setup Wizard will be initialized. The Setup Wizard provides guided assistance in configuring the LCD TV to your preference language, Time Zone, Daylight Saving, RF Input Source and Scanning Channel by sequence. You can select your favorite settings step by step.

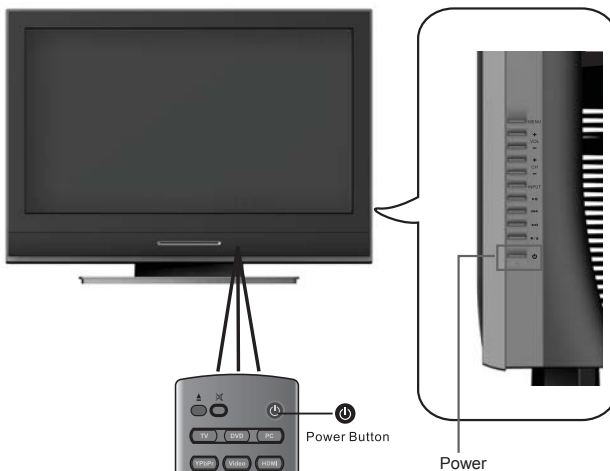

## Setup Wizard

(1) Press "▲ / ▼" to select the language for menu and message showing on your TV, press Enter key to exit Setup Wizard menu.

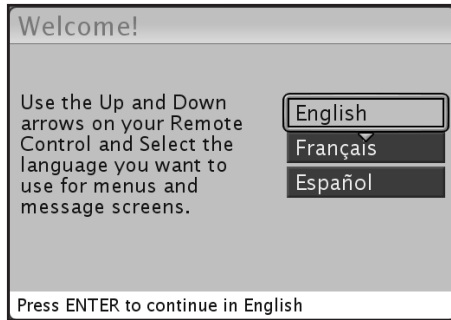

(2) Press ENTER to access Time Zone settings.  
Press "▲ / ▼" to select on your time zone.

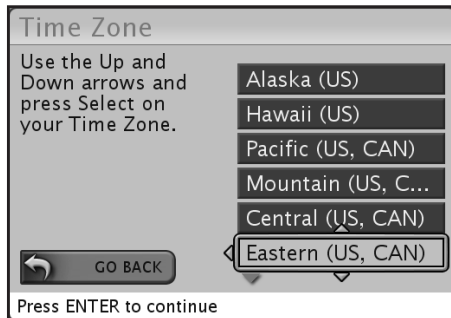

(3) Press ENTER to access Daylight Saving screen.  
Press "▲ / ▼" to select "Yes" or "No", when you observe daylight saving.

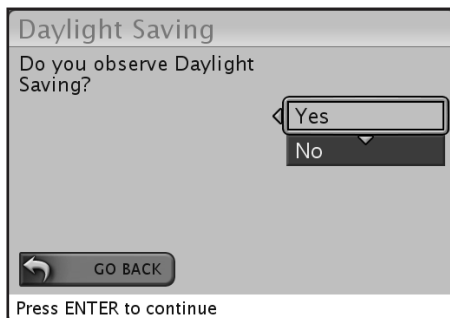

# INSTALLATION

- (4) Press **ENTER** to access RF Input Source screen.  
Press "▲ / ▼" to select the source for your TV signal.

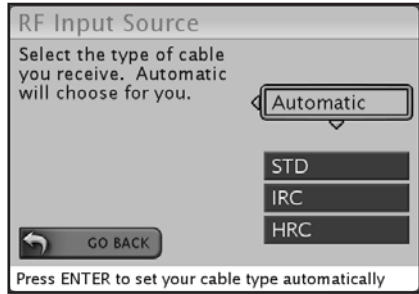
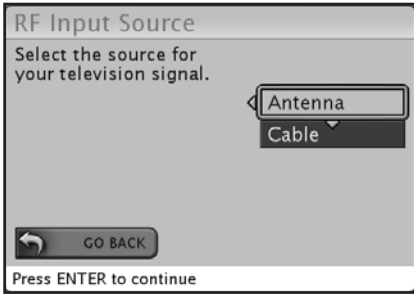

► Note: Select STD(Standard) for majority of cable systems.

- (5) Press **ENTER** to start the Channel Scan.  
Scanning channel searches available digital (HDTV) and analog (SDTV) channels of selected TV source, the numbers of available channels will show on the OSD menu. It may take a few minutes

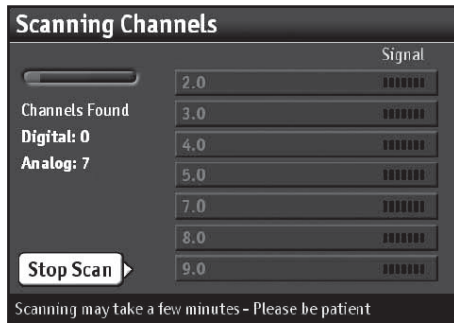

## 1. TURNING ON AND OFF THE POWER

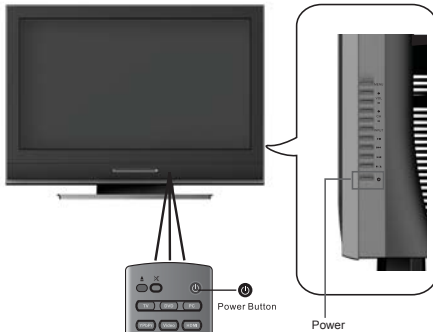

POWER indicator	
Power ON	Lighting (Blue)
Power OFF	Light Off

### • Turning On the Power

- Press on the TV or on the remote control.
- POWER indicator (Blue): The TV is on.

### • Turning Off the Power

- Press on the TV or on the remote control.
- The TV enters standby mode and the image on the screen disappears.
- The POWER indicator on the TV turns off.

► Note:

- If you are not going to use this TV for a long time, be sure to remove the AC power cord from the wall outlet.
- Small amount of electric power is still consumed even when the power is turned off.

## 2. SOUND VOLUME

### • To adjust the volume



- Press VOL (+) to increase the sound volume. The bar indicator shifts right.

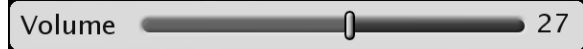

- Press VOL (-) to decrease the sound volume. The bar indicator shifts left.



### • To mute the sound

- Press MUTE to turn off the sound.

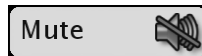

- Press MUTE or VOL (+)/(-) to turn the sound back to the previous level.

# BASIC OPERATION

## 3.CHANGING CHANNELS



• You can select channels using **Channel Select** (0-9, • (DOT), ENT) or CH (+)/(-).

### • Using Channel Select (0-9, • (DOT), ENT)

When selecting the channel using Channel Select, complete input of the channel number by holding down the button for the last digit for a moment.

### •To select a 1- or 2-digit channel number (e.g., Channel 5):

Complete the following procedure within 4 seconds.

- 1.Press the (0) button.
- 2.Press the (5) button.
- 3.Press the (ENT) button.

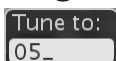
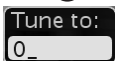

### •To select a 3-digit channel number (e.g. Channel 115):

Complete the following procedure within 4 seconds.

- 1.Press the (1) button.
- 2.Press the (1) button.
- 3.Press the (5) button.
- 4.Press the (ENT) button.

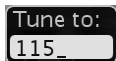
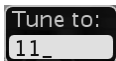
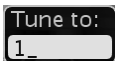

### •To select a digit channel number (e.g. Channel 5.1):

Complete the following procedure within 4 seconds.

- 1.Press the (5) button.
- 2.Press the (.) button.
- 3.Press the (1) button.
- 4.Press the (ENT) button.

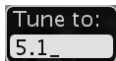
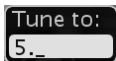
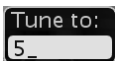

### • Using LAST

•Press (LAST) to switch the currently tuned channel to the previously tuned channel.

•Press (LAST) again to switch back to the currently tuned channel.



## 4.INPUT SELECTION



- 1.Press **TV,DVD,PC,YPbPr,Video,HDMI** on Remote Control directly.



Input

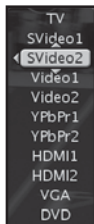

2. a:Press Input on the remote control to display the Input list.  
b:Press ▲/▼ to select the desired source.  
c:Press ENTER to switch the input source.

## 5. SELECTING MENU ITEMS





The menu can be used to adjust the various settings of the LCD TV set. Select the desired menu item by following the steps below.

►NOTE:

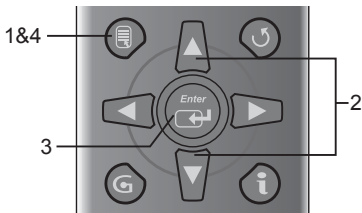
- The items displayed differ depending on the setting conditions.
- The item selected is displayed in blue.
- Last setting will be saved in memory.

### •Using the remote control



1. Press  on the remote control to display the Menu screen.
2. Press  /  to select the desired menu item.
3. Press **Enter** to select the menu item.
4. Press  to exit.

### •Using the control panel of the main unit

You can also operate the menu with the control panel of the main unit.

Button operations on the control panel correspond to the ones on the remote control as shown below.

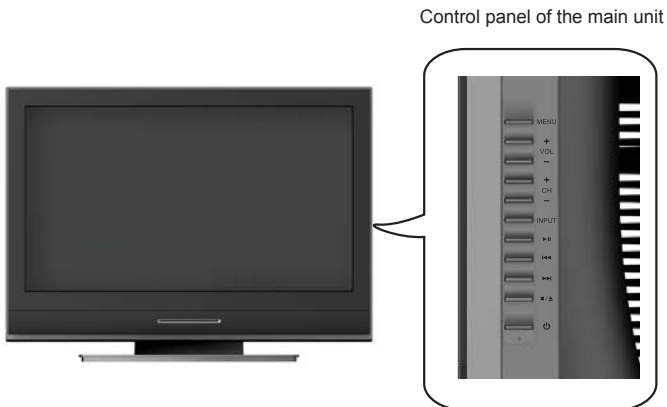

**VOL (-)/(+):** Cursor  /  on the remote control

**CH (-)/(+):** Cursor  /  on the remote control

**MENU:** MENU on the remote control

**INPUT:** ENTER on the remote control



# MENU OPERATION

## •Menu Setting screens

For details of each menu item, refer to the page number indicated below.

### ▶NOTE:

- The illustrations and on-screen displays in this manual are for explanation purposes and may vary slightly from the actual appearance.
- Depending on the setting condition, such source input, it may not be possible to adjust or set some items.

## Video

	Page
Preset Mode.....	26
Video Settings.....	26
Screen Size.....	27
Color Temp.....	27
VGA Settings.....	28
Video Reset.....	29

## Audio

	Page
Bass, Treble & Balance.....	29
Optical Out(SPDIF).....	30
Analog Preference.....	30
Digital Preference.....	31
TV Speaker.....	31
Audio Only.....	32
Reset Audio.....	32

## Channels

	Page
Channels List.....	33
Favorites.....	34
Scan Channels.....	35
Find Channels.....	36
Edit Channel Name.....	36

## Locks

	Page
Rating Locks.....	38
Channel Locks.....	40
Front Panel Lock.....	40
Change PIN.....	40
DVD Locks.....	41
Reset Locks.....	41

## Settings

	Page
Menu Language.....	42
Date & Time.....	42
Weekly Timers.....	45
Sleep Time.....	46
Closed Captions.....	46
Activation.....	46
Input Labels.....	48
Autosource.....	49
Power Management.....	49
Power on plug.....	49
Power LED.....	50
DVD Restoration.....	50
System Info.....	51
Reset All.....	51

## Advanced

	Page
Cinemotion.....	52
3D Comb Filter.....	53
Deinterlaced.....	53
Noise Reduction.....	53
Brightness.....	54
Contrast.....	54
Saturation.....	54
Hue.....	54
Sharpness.....	54
Backlight.....	54
User Color Temp.....	54
Reset Advanced.....	55



## Guide

Page

## 1. VIDEO

•You can adjust the Video to your preference with the following Video settings.



- 1.Press  **MENU** on the remote control to display the menu screen.
- 2.Press **▶ / ▲ / ▼** to select the Video menu.
- 3.Press **Enter** to enter the Video menu list.
- 4.Press **▲ / ▼** to select the desired menu item.
- 5.Press **Enter** to select the menu item.
- 6.Press  **EXIT** to exit after finish adjustment.

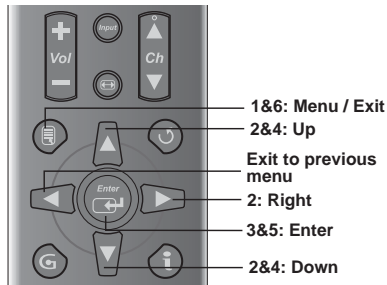

# MENU OPERATION

## 1-1 Preset Mode:

Upon the watching program, you can select an appropriate video setting with the preset mode.



Selected Item	Description
Movie	Controlling the contrast to enable easier viewing of dark images.
Sports	For a clear-cut image emphasizing high contrast for sports viewing.
Game	Controlling the brightness of video games and other images for easier viewing.
Enhanced	Increased color and sharpness for vibrant out of box performance
User	Allows the user to customize setting as desired. You can set the preferences for each input source.

## 1-2 Video Settings:

The Video Settings sub-menu allows adjustments to display settings such as brightness, contrast, saturation, hue, sharpness and backlight level. Menu options may vary depending on the input source.

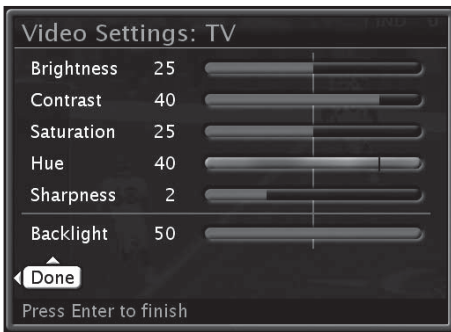
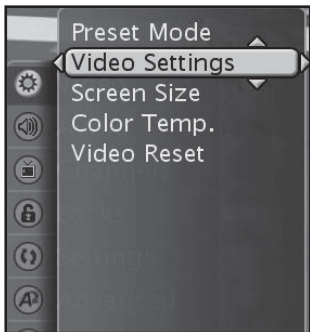

## 1-3 Screen Size:

The Screen Size sub-menu option adjusts the manner in which source signal formats are displayed on the screen.

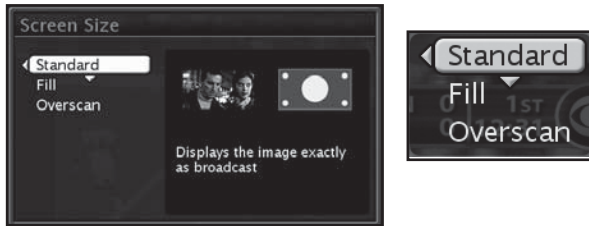

\*You can also use  on your remote control for this function.

## 1-4 Color Temp



Selected Item	Description
Cool	White with bluish tone
Neutral	Neutral white
Warm	White with reddish tone
User	Adjust the color to your preference

# MENU OPERATION

## 1-5 VGA Setting:

Adjust VGA Setting of your TV (Horizontal, Vertical, Phase, Auto Sync).

►Note:

- Make sure to select the input signal from the following PC Compatibility Chart before a PC.

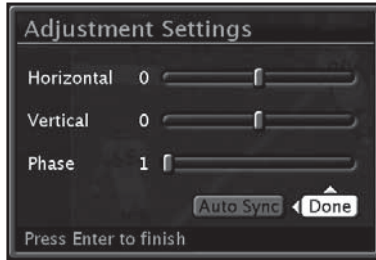

Selected Item	◀button	▶button
Horizontal	Move the image Horizontal position to the left.	Move the image Horizontal position to the right.
Vertical	Move the image Vertical position down.	Move the image Vertical position up.
Phase	Adjust image clarity	

Selected Item	Description
Auto Sync	Automatically adjust the settings for the current input signal

►Note:

- VGA Setting is only available when selecting the VGA Input.
- PC Compatibility Chart

PC / MAC	Resolution		Horizontal	Vertical
			Frequency (kHz)	Frequency (Hz)
PC	VGA	720 x 400	31.5	70
			31.5	60
		640 x 480	37.9	72
			37.5	75
	SVGA	800 x 600	35.1	56
			37.9	60
			48.1	72
			46.9	75
	XGA	1024 x 768	48.4	60
			60	75
	WXGA	1360 x 768	47.7	60
		1366 x 768	48.45	60

►Note:

- The numerical values of resolutions and frequencies mentioned above are standard. They may differ from the values when actually displayed.

## 1-6 Video Reset :

Reset all Video sub-menu options to the factory defaults.



## 2. AUDIO



### 2-1 Bass, Treble & Balance:

Use ▲ / ▼ / ◀ / ▶ to select or adjust your favorite bass, treble and balance settings.



# MENU OPERATION

## 2-2 Optical out (SPDIF):

Select the audio format for Optical Out (AC3, PCM).



Selected Item	Description
AC3	Select surround audio format
PCM	Select stereo audio format

► Note:

- Optical Out (SPDIF) is only available for DVD or when receiving digital broadcasting.

## 2-3 Analog Preference:

The Analog Preference sub-menu sets the audio output to the desired listening preference. The available settings are Mono (single stream), Stereo (left and right stream) and SAP (Secondary Audio Programming such as a foreign language track).

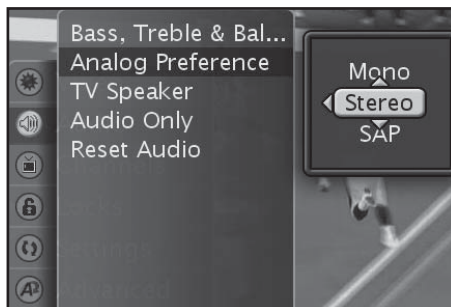

## 2-4 Digital Preference:

Select the digital Broadcasting preferred language (English, French, Spanish).



Selected Item	Description
English	Set Digital Broadcasting preferred language to English
French	Set Digital Broadcasting preferred language to French
Spanish	Set Digital Broadcasting preferred language to Spanish

► Note:

- Digital Preference is only available when receiving digital broadcasting.

## 2-5 TV Speaker

The TV Speaker sub-menu sets the speaker output preference. The available settings are as follows:



Selected Item	Description
Internal	Audio from internal speakers only.
External	Audio from external speakers, such as if the TV was connected to a stereo receiver.
Mixed	Audio from both internal and external speakers.



# MENU OPERATION

---

## 2-6 Audio Only.

Audio Only is a listening mode by turning off the LCD backlight and allowing the current input's audio to remain "on" for listening. You can enable Audio Only mode from OSD menu.

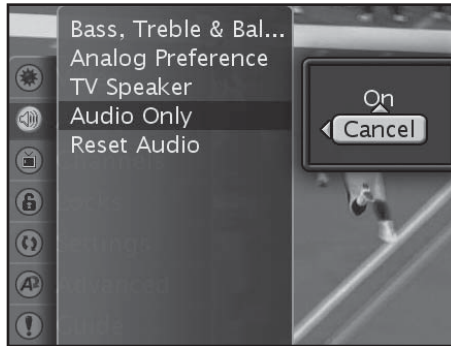

On: enable Audio Only mode.

When Audio Only is on, LED light shows blue.

Note: Volume +, Volume -, Right Arrow, Left Arrow, and Mute on the remote control can still control the system volume level as a normal operation.

Cancel: disable Audio Only mode

Audio Only model could be disabled via below.

- a. Select Cancel on Audio Only sub-menu.
- b. Single button push on the remote control or side control keys excluding Volume +, Volume -, Right Arrow, Left Arrow, and Mute. These buttons function as normal audio adjustment.
- c. No Signal Detected  
If a source is powered off or video cable is unplugged, Audio Only would be disabled.
- d. New signal detected by Autosource  
When a new signal is detected by Autosource, Audio Only will be disabled.
- e. Rating Locks on Parental Controls are set.  
Audio Only is disabled, TV system continues to block both video and audio as normal.

## 2-7 Reset Audio

Reset all Audio sub-menu options to the factory defaults.



## 3. CHANNELS

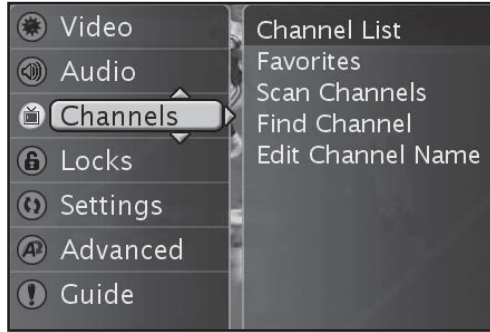

### 3-1 Channel List

The Channel List sub-menu defines which channels are available for viewing when utilizing the analog/digital tuner.



Selected Item	Description
Check All	Select all channels from Master Channel List
Uncheck All	Unselect all channels from Master Channel List
Analog Only	Select all analog channels from Master Channel List
Digital Only	Select all digital channels from Master Channel List

# MENU OPERATION

## 3-2 Favorites

The Favorites sub-menu adds or subtracts channels from the favorite channels list. Channels added to the list can be accessed by pressing the FAV A, FAV B or FAV C button on the remote control instead of directly entering the channel number.

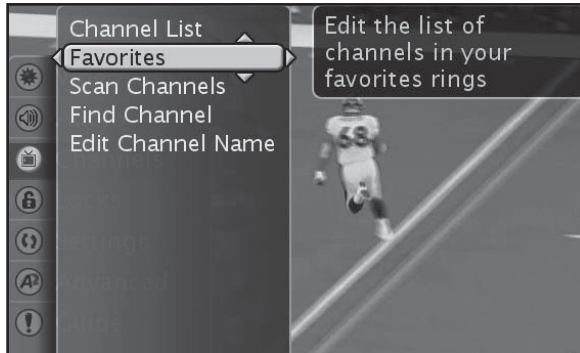

The following sub-menu items allow for modification of the favorite channel lists. Use the arrow buttons on the remote control to scroll through the available channels, then use the **ENTER** button on the remote control to add/remove the selected channel.

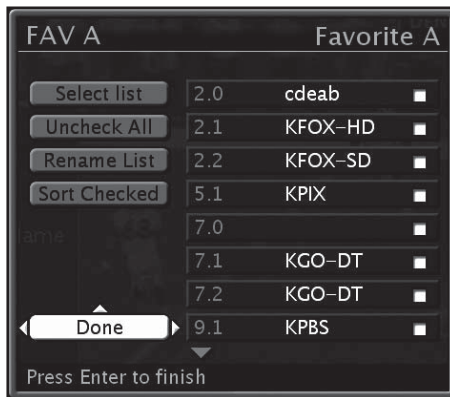

Selected Item	Description
Select List	Select the favorite channels list to be edited.
Uncheck All	Remove all of channels from the current favorite channel list
Rename List	Rename the favorite channel list.
Sort Checked	Sort or unsorted checked channels in the list.

### 3-3 Scan Channels

The Scan Channels sub-menu automatically scans for available channels based upon the source input selected. If scanning for OTA (over the air) channels, select Antenna as the input source. If scanning for Cable channels, select Cable as the input source

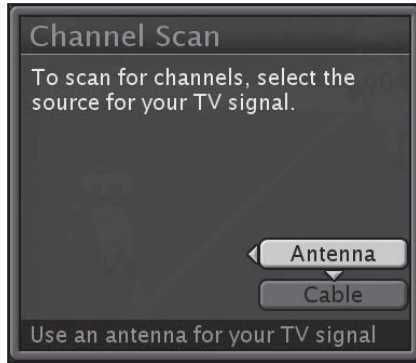

After selecting the input source, activate the Scan button to initiate scanning or cancel the scan function by selecting **Stop Scan**.

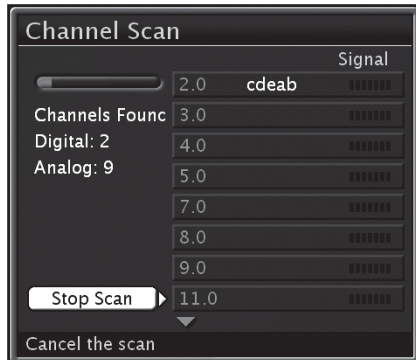

When selecting Cable as the scan input source, a sub-menu will appear for selecting a cable TV signal type. The signal type is determined by the cable provider. If unsure about the proper signal type, use the "Automatic" option.

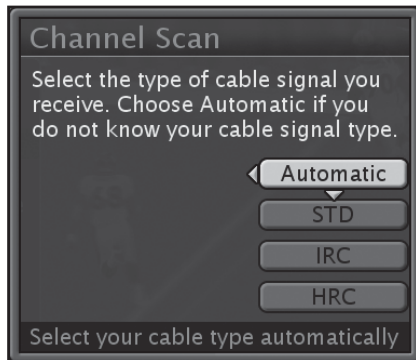

# MENU OPERATION

---

## 3-4 Find Channel

The Find Channel sub-menu allows for manual addition of user specified channels.



## 3-5 Edit Channel Name

The Channel Name Edit sub-menu allows for modification of the friendly name of any channel within the channels list. To modify a channel name, select the Channel Name Edit sub-menu, scroll through the list of available channels and press the **ENTER** button to modify the desired channel name.



Enter the new channel name using the on-screen characters. Select the "Done" button to save the new name and return to the channel list.

## 4. LOCKS

The Locks menu provides the ability to set ratings that block programming that may be inappropriate for the viewing audience such as programs and movies that contain violence, adult language or nudity.



A personal identification number (PIN) will need to be created the first time the Locks menu is accessed. Enter the new PIN using the remote control, then confirm the new PIN to save it. Once the PIN has been created, the PIN Entry box will appear whenever attempting to modify the Locks menu.



Once the PIN has been configured, the user has access to 6 sub-menu items. (Ratings Locks, Channel Locks, Front Panel Lock, Change PIN, DVD Locks and Reset Locks)

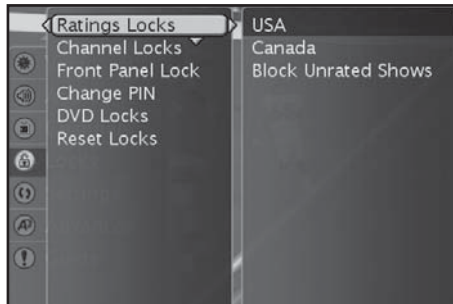

# MENU OPERATION

## 4-1 Rating Locks

The Ratings Locks sub-menu blocks programming based upon the TV or Movie rating for the country specified.

►Note: The Ratings Locks are only valid for the North American market.

►Note: The Ratings Locks menu is only applicable when the input source is the TV tuner.

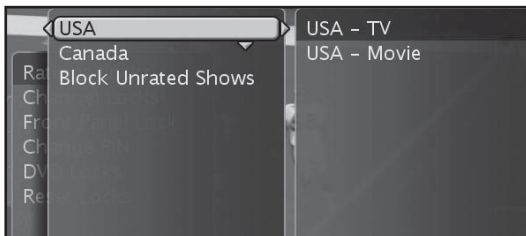

USA TV Ratings as determined by the FCC.



TV-Y	Suitable for young children
TV-Y7	May not be suitable for children under 7
TV-G	Suitable for all audiences
TV-PG	Parental guidance suggested
TV-14	Parental guidance suggested for children under age 14
TV-MA	Suitable for mature audiences or adults only

USA Movie Ratings as determined by the MPAA  
(Motion Picture Association of America)

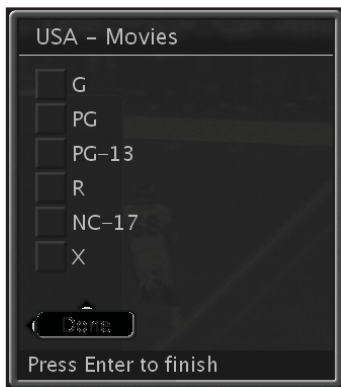

G	General audience
PG	Parental guidance suggested
PG-13	Parents strongly cautioned
R	Restricted
NC 17	No one 17 and under admitted

►Note:

•Choosing a lower age-based rating blocks the higher age-based ratings regardless of content rating settings.

# MENU OPERATION

Canadian (French) ratings as defined by the Regie du Cinema.

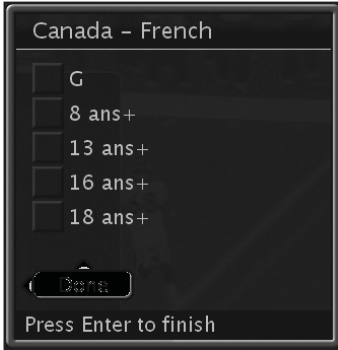

G	General programming, suitable for all audiences
8 ans+	Children eight years and older
13 ans+	Viewers 13 years and older
16 ans+	Viewers 16 years and older
18 ans +	Adult programming

Canadian (English) ratings as defined by the Regie du Cinema.

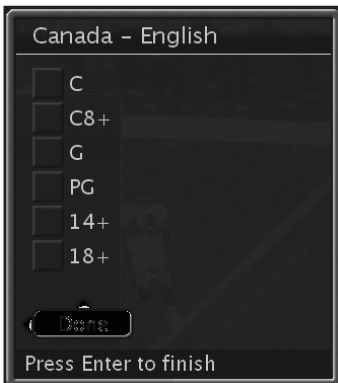

C	Children
C8+	Children eight years and older
G	General programming, suitable for all audiences
PG	Parental guidance
14+	Viewers 14 years and older
18+	Adult programming

Block Unrated Shows

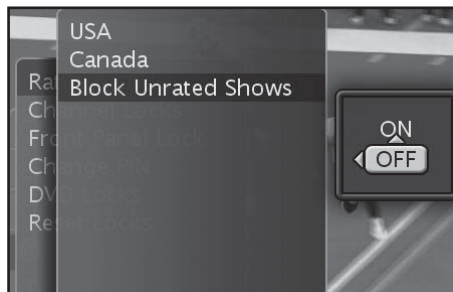

Selected Item	Description
ON	Block all unrated TV programs
OFF	No TV program will be blocked



# MENU OPERATION

## 4-2 Channel Locks

The Channel Locks sub-menu provides individual channel blocking regardless of any ratings lock in place.



## 4-3 Front Panel Lock

This important feature is for use in an environment where the display's owner does not want the conditions of the display changed. You can enable or disable it from OSD menu.



## 4-4 Change PIN

The Change PIN sub-menu allows the user to set up a new PIN. The original PIN is required to make any change.



## 4-5 DVD Locks

Set restriction of DVD programs with Rating Locks.



Selected Item	Description
View All	No Lock.
Kid Safe	Just release the content appropriate for children under 12
No Adult	Just lock the content appropriate for adult.

## 4-6 Reset Locks

Reset all channel and rating locks to the factory defaults. (unlocked)



# MENU OPERATION

## 5. SETTINGS

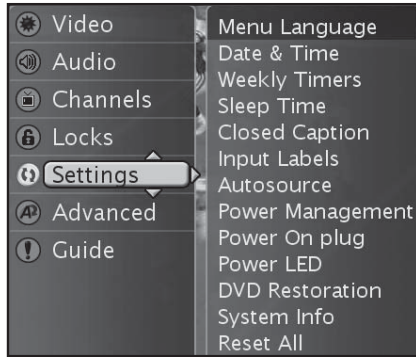

### 5-1 Menu Language



The Menu Language sub-menu toggles the default language for the on-screen display menus.



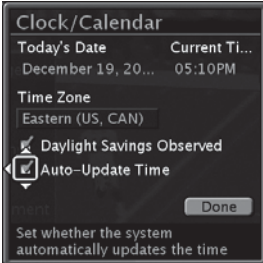
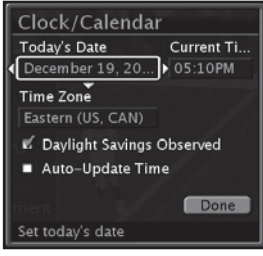

### 5-2 Date & Time

Set the current time and date.

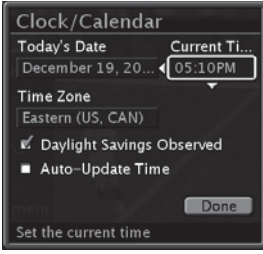
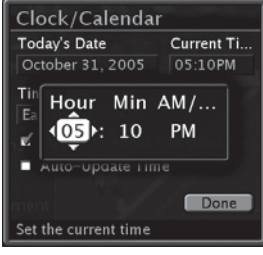
A screenshot of the TV's menu with the 'Date & Time' sub-menu open. The sub-menu options are: Adjust the system date and time, daylight saving time, and auto-update. The background menu items are visible behind the sub-menu.	<p>1. Press ► to set the current time and date on TV.</p>
--	---

 <p>Clock/Calendar</p> <p>Today's Date      Current Ti... December 19, 20...    05:10PM</p> <p>Time Zone Eastern (US, CAN)</p> <p><input checked="" type="checkbox"/> Daylight Savings Observed <input checked="" type="checkbox"/> Auto-Update Time</p> <p>Done</p> <p>Set whether the system automatically updates the time</p>	<p>2. Press ▲ to select "Auto-Update Time". 3. Press <b>ENTER</b> to cancel the check.</p> <p>Note: When you check the "Auto-Update Time", you cannot adjust the date and time.</p>
 <p>Clock/Calendar</p> <p>Today's Date      Current Ti... December 19, 20...    05:10PM</p> <p>Time Zone Eastern (US, CAN)</p> <p><input checked="" type="checkbox"/> Daylight Savings Observed <input type="checkbox"/> Auto-Update Time</p> <p>Done</p> <p>Set today's date</p>	<p>4. Press ▲ to select "Today's Date". 5. Press <b>ENTER</b> to adjust the "Today's Date".</p>
 <p>Clock/Calendar</p> <p>Today's Date      Current Ti... October 31, 2005    05:10PM</p> <p>Time Zone Eastern (US, CAN)</p> <p><input checked="" type="checkbox"/> Daylight Savings Observed <input type="checkbox"/> Auto-Update Time</p> <p>Done</p> <p>Set today's date</p>	<p>6. Press ▲/▼ or number key (0-9) until the correct Month appears. 7. Press ► to select Date. 8. Repeat item 6 and 7 to adjust Date &amp; Year. 9. Press <b>ENTER</b> to exit after finishing adjustment.</p>
 <p>Clock/Calendar</p> <p>Today's Date      Current Ti... December 19, 20...    05:10PM</p> <p>Time Zone Eastern (US, CAN)</p> <p><input checked="" type="checkbox"/> Daylight Savings Observed <input type="checkbox"/> Auto-Update Time</p> <p>Done</p> <p>Set the current time</p>	<p>10. Press ▲ to select "Current Time". 11. Press <b>ENTER</b> to adjust the "Current Time".</p>
 <p>Clock/Calendar</p> <p>Today's Date      Current Ti... October 31, 2005    05:10PM</p> <p>Time Zone Eastern (US, CAN)</p> <p><input checked="" type="checkbox"/> Daylight Savings Observed <input type="checkbox"/> Auto-Update Time</p> <p>Done</p> <p>Set the current time</p>	<p>12. Press ▲/▼ or number key (0-9) until the correct Hour appears. 13. Press ► to select Min. 14. Repeat item 12 and 13 to adjust Minutes &amp; AM/PM. 15. Press <b>ENTER</b> to exit after finishing adjustment.</p>

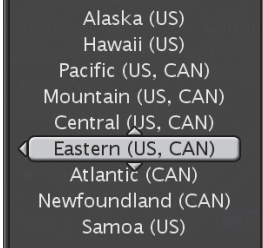
# MENU OPERATION

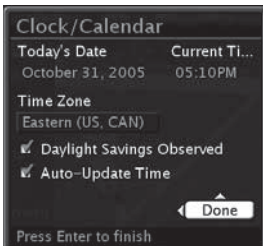
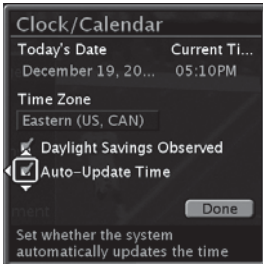
 <p>Clock/Calendar          Today's Date    Current Ti...          December 19, 20...    05:10PM  <b>Time Zone</b>          ◀ Eastern (US, CAN)  <input checked="" type="checkbox"/> Daylight Savings Observed  <input checked="" type="checkbox"/> Auto-Update Time          Done          Set your time zone</p>	<p>16. Press ▼ to select "Time Zone".          17. Press <b>ENTER</b> to list to Time Zone.</p>
 <p>Alaska (US)          Hawaii (US)          Pacific (US, CAN)          Mountain (US, CAN)          Central (US, CAN)          ◀ Eastern (US, CAN)          Atlantic (CAN)          Newfoundland (CAN)          Samoa (US)</p>	<p>18. Press ▲ or ▼ to select the Time Zone you stay.          19. Press <b>ENTER</b> to exit.</p>
 <p>Clock/Calendar          Today's Date    Current Ti...          December 19, 20...    05:10PM  <b>Time Zone</b>          Eastern (US, CAN)          ◀ <input checked="" type="checkbox"/> Daylight Savings Observed  <input checked="" type="checkbox"/> Auto-Update Time          Done          Set whether the system automatically adjusts for daylight saving time</p>	<p>20. Press ▼ to select "Daylight Savings Observed".          21. Press <b>ENTER</b> to check it if your time zone observes the daylight saving.</p>
 <p>Clock/Calendar          Today's Date    Current Ti...          October 31, 2005    05:10PM  <b>Time Zone</b>          Eastern (US, CAN)  <input checked="" type="checkbox"/> Daylight Savings Observed  <input checked="" type="checkbox"/> Auto-Update Time          Done          Press Enter to finish</p>	<p>22. Press ▼ to select "Done".          23. Press <b>ENTER</b> or ◀ to exit after finishing adjustment.</p>
 <p>Clock/Calendar          Today's Date    Current Ti...          December 19, 20...    05:10PM  <b>Time Zone</b>          Eastern (US, CAN)  <input checked="" type="checkbox"/> Daylight Savings Observed          ◀ <input checked="" type="checkbox"/> Auto-Update Time          Done          Set whether the system automatically updates the time</p>	<p>Note:          •After finishing adjustment, please don't check the "Auto-Update Time".          •If you check the "Auto-Update Time", Time will update by Antenna source.          •If you don't check the "Auto-Update Time", you should reset it after blackout or you unplug AC power cord.</p>

## 5-3 Weekly Timers

This function allows you to set the TV to turn on and off at scheduled time. You can set two different timers.

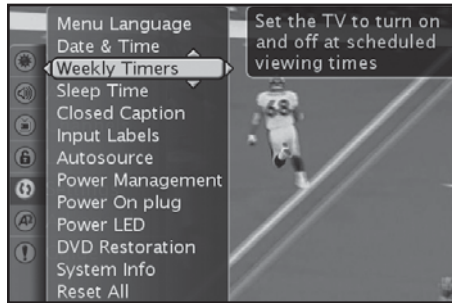

	<ol style="list-style-type: none"> <li>1. Press <b>▲</b> to choose Timer.</li> <li>2. Press <b>ENTER</b> to select "Timer 1" or "Timer 2".</li> <li>3. Press <b>▼</b> / <b>▶</b> / <b>◀</b> and <b>ENTER</b> to check the days you desired.</li> <li>4. Press <b>▼</b> to set the Start Time.</li> </ol>
	<ol style="list-style-type: none"> <li>5. Press <b>ENTER</b> to adjust the "Start Time".</li> <li>6. Press <b>▲/▼</b> or number key (0-9) to set the "Duration"</li> <li>7. Have a check on "Timer is on".</li> <li>8. Press <b>▼</b> to select "Done".</li> <li>9. Press <b>ENTER</b> or <b>▶</b> to exit after finish setting.</li> </ol>

# MENU OPERATION

## 5-4 Sleep Timer

This function allows you to set the sleep time to automatically turn off the TV.

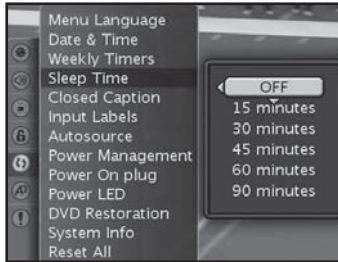

Selected item	Description
OFF	Set Sleep Time to off
15 minutes	Automatically turn off the TV after 15 minutes
30 minutes	Automatically turn off the TV after 30 minutes
45 minutes	Automatically turn off the TV after 45 minutes
60 minutes	Automatically turn off the TV after 60 minutes
90 minutes	Automatically turn off the TV after 90 minutes

## 5-5 Closed Captions

Closed Captions provide on-screen text in conjunction with the audio program for those who are deaf or hard of hearing.

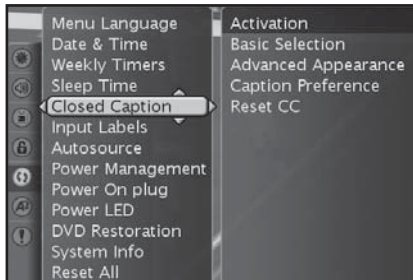

### 5-5-1 Activation

Activate Closed Caption.

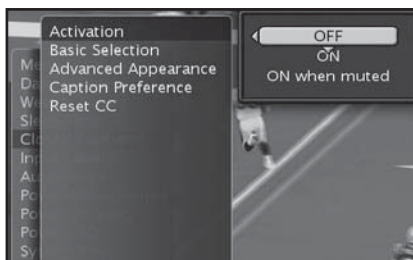

Selected item	Description
OFF	Set Closed Caption to OFF
ON	Set Closed Caption to ON
ON when muted	Set Closed Caption to ON when muted.

## 5-5-2 Basic Selection

The Basic Selection sub-menu configures the video frame field setting for closed captioning content. Most closed caption content can be found within CC1.

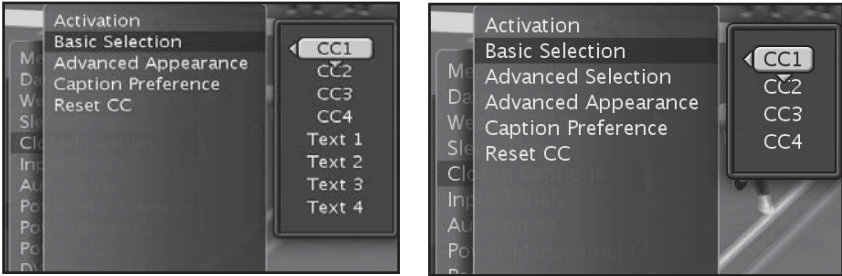

## 5-5-3 Advanced Selection

The Advanced Selection sub-menu provides enhanced closed caption options for the CC experience.

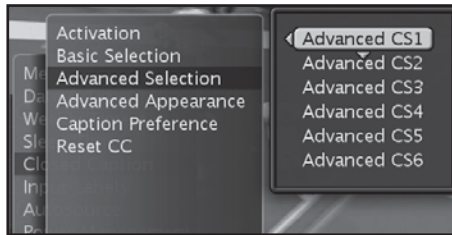

► Note:

- Advanced Selection is only available when receiving digital broadcasting.

## 5-5-4 Advanced Appearance

The Advanced Appearance sub-menu provides customization of the CC text through font, size, color and display options.

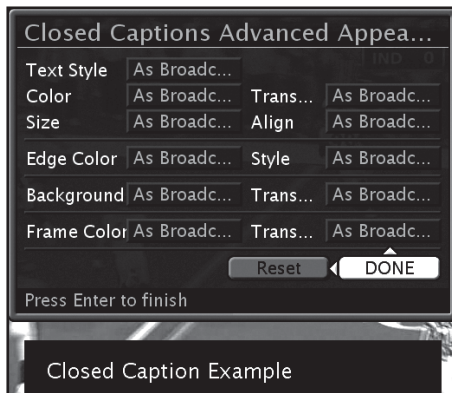



# MENU OPERATION

---

## 5-5-5 Caption preference

The Caption Preference sub-menu sets the default caption. If Automatic, the caption is determined by the broadcast.

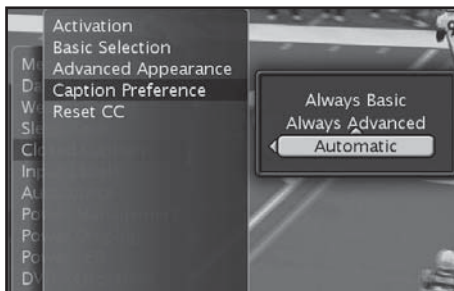

## 5-5-6 Reset CC

Reset all Closed Caption settings to the factory defaults.

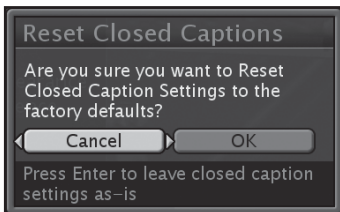

## 5-6 Input labels

The Input Labels sub-menu allows for modification of the friendly name for the input port list. To modify an input port label, select the Input Labels sub-menu, scroll through the list of available inputs, choose one of the pre-selected input port descriptions or create a custom label.

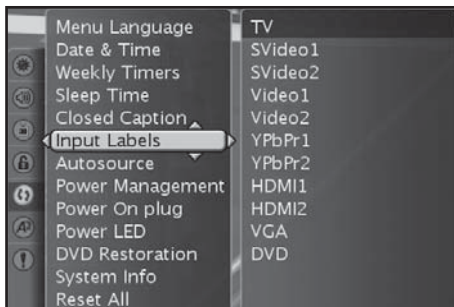

## 5-7 Autosource

If the "Autosource" is ON, once you plug in or power on a new source, the TV will detect it and automatically switch to the new input.



## 5-8 Power Management

The Power Management sub-menu configures the power state of the LCD-TV when turned off.



Selected Item	Description
Normal	The TV into a low power standby state. And the TV can be turned on quickly.
Energy Saving	The TV turns off all power. And the TV must be fully booted each time.

## 5-9 Power On plug

Memorize the DC power status while AC power off.

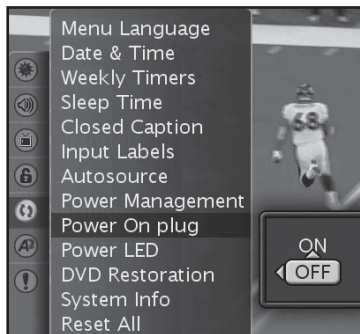

Selected Item	Description
ON	If last DC power status is on, TV will power on automatically when power is disconnected then reconnected.
OFF	Turn off Power On Plug function.

# MENU OPERATION

## 5-10 Power LED

Set LED indicator on bezel to On or OFF

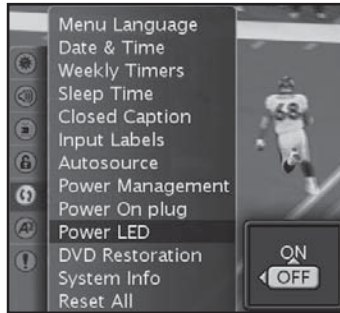

Selected Item	Description
ON	Turn on LED indicator
OFF	Turner off LED indicator

## 5-11 DVD Restoration

DVD Restoration Mode is a functional setting that restores the anamorphic DVD to its original intended viewing mode. This is done by determining the flag setting and adjusting Standard Aspect Mode accordingly. When the flag is set and the current mode is on standard, then the system will follow the DVD Restoration mode settings

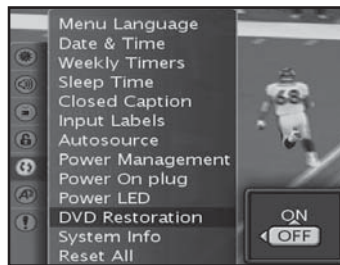

► Note:

This only effects 4:3 Video with Standard aspect setting.

## 5-12 System Info

The System Info sub-menu provides detailed information about the LCD-TV and its operating status. Information provided includes the system firmware version as well as the current input source and signal types being decoded.



## 5-13 Reset All

Reset all settings back to factory defaults. Reset All will delete all settings you have made including language, time zone, channel list....etc. You must run Setup Wizard after a reset, please refer to page 18.

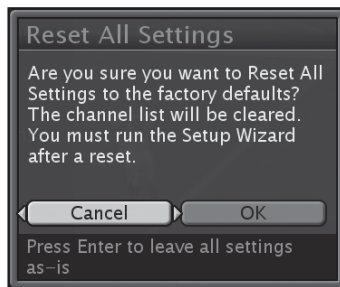

# MENU OPERATION

## 6.ADVANCED

You can adjust the video to your preference with the following settings.



### 6-1 Cinemotion

Detect a film-based source (originally encoded at 24 frames/second) and then recreate each still film frame to cinematic picture quality (ON, OFF).

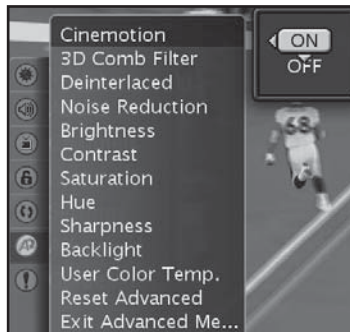

Selected Item	Description
ON	Set Cinemotion to ON
OFF	Set Cinemotion to OFF

## 6-2 3D Comb Filter

Select 3D comb filter to Off,Low,Medium,High.



Selected Item	Description
<b>Off</b>	Set 3D Comb Filter to Off
<b>Low</b>	Set 3D Comb Filter to Low level
<b>Medium</b>	Set 3D Comb Filter to Medium level
<b>High</b>	Set 3D Comb Filter to High level

## 6-3 Deinterlaced

Select image display to Progressive or Interlace (ON, OFF).

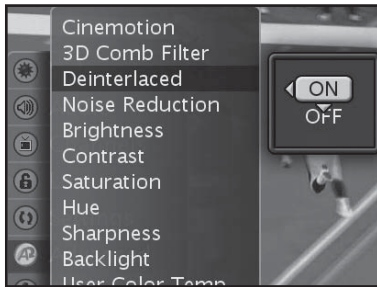

Selected Item	Description
<b>ON</b>	Display image in Progressive scan
<b>OFF</b>	Display image Interlace

## 6-4 Noise Reduction

Reduce noise from TV screen.(Off,Low,Medium,High ).

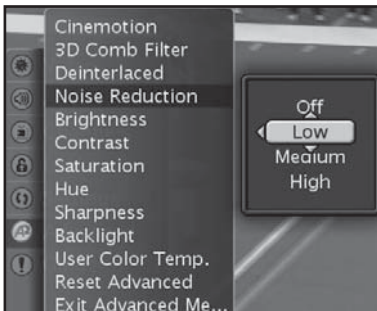

Selected Item	Description
<b>Off</b>	Set Noise Reduction to Off
<b>Low</b>	Set Noise Reduction to Low level
<b>Medium</b>	Set Noise Reduction to Medium level
<b>High</b>	Set Noise Reduction to High level

# MENU OPERATION

## 6-5 Brightness



Selected Item	◀button	▶button
Brightness	For less brightness	For more brightness

## 6-6 Contrast



Selected Item	◀button	▶button
Contrast	For less contrast	For more contrast

## 6-7 Saturation



Selected Item	◀button	▶button
Saturation	For less color intensity	For more color intensity

## 6-8 Hue



Selected Item	◀button	▶button
Hue	Skin tones become purplish	Skin tones become greenish

## 6-9 Sharpness



Selected Item	◀button	▶button
Sharpness	For less sharpness	For more sharpness

## 6-10 Backlight



Selected Item	◀button	▶button
Backlight	The screen dims	The screen brightens

## 6-11 User Color Temp



Selected Item	◀button	▶button
Red	Weaker red	Stronger red
Green	Weaker green	Stronger green
Blue	Weaker blue	Stronger blue

## 6-12 Reset Advanced

Reset Advanced Settings to factory preset values.

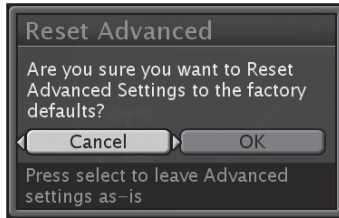

## 7.GUIDE

The Guide menu displays program information for the current channel such as signal strength, audio/video signal type, channel number, V-Chip support, closed captioning status and program title.

► Note: The Guide menu is only applicable when viewing digital television through the TV tuner.

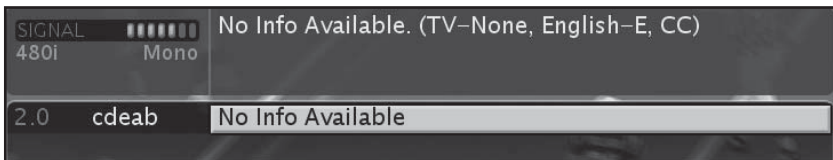



# PLAYING A DISC

## 1.PLAYBACK PROCEDURE

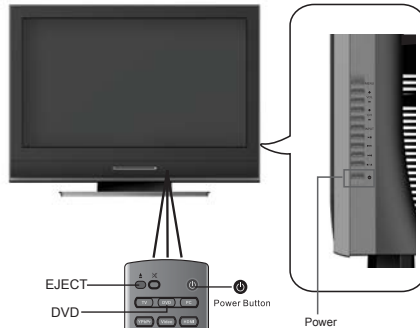

- (1) Press POWER on the unit or on the remote control to turn on the unit.
  - Every time you press POWER, the TV/DVD will start from previous mode.
- (2) Press DVD on the remote control to select DVD mode.
  - The DVD startup screen will appear on the screen.
  - (If DVD disc has already loaded, playback will start automatically.)
- (3) Load the disc in the disc slot.



- Load the disc in the disc slot with the label side facing upward. (If the disc has a label.)
    - Hold the disc without touching either of its surfaces, align it with the guides, and place it in position.
  - When you play the 8cm disc, you need an adapter (not supplied), or you will damage the DVD player.
- (4) On the TV-screen, "READ" will appear on the upper left side and playback commences.
    - A menu screen will appear on the TV screen, if the disc has a menu feature.
    - Press ►/ ◀ or ▲ / ▼ to select title, then press ENTER. Title is selected and play commences.
  - (5) Press ■ STOP to end playback.
    - The unit records the stopped point, depending on the disc. "■" appears on the screen.
    - Press ►► PLAY to resume playback from the scene point.
    - If you press ■ STOP again ("■" appears on the screen.), the unit will clear the stopped point.
  - (6) Press ▲ EJECT to remove the disc.

### ►Note:

- If a non-compatible disc is loaded, "READ" changes to "■" will appear on the screen. In this case, check your disc again (see pages 7).
- Some discs may take a minute or so to start playback.
- When you set a single-faced disc label downwards (ie. The wrong way up), "READ" will appear on the display for several seconds and then "NO IDSC" appears on the screen and eject the disc automatically.
- Some discs may not work the resuming facility.
- Some playback operations of DVDs may be intentionally fixed by software producers. Since this unit plays DVDs according to the disc contents the software producers designed, some playback features may not be available. Also refer to the instructions supplied with the DVDs.

## 2.SPECIAL PLAYBACK

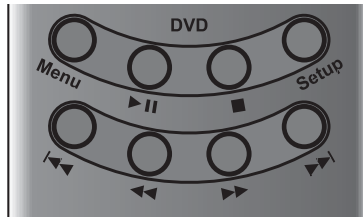

### (1).Fast Forward Playback

Press ►► during normal playback.

Each press of ►► will increase the speed of the search (x 2), (x 4), (x 8), (x 20).

To resume normal playback, press ►|| to play.

### (2).Fast Reverse

Press ◀◀ during normal playback.

Each press of ◀◀ will increase the speed of the search (x 2), (x 4), (x 8), (x 20).

To resume normal playback, press ►|| to play.

### (3).Still Playback

Press ►|| during normal playback to pause playback.

To resume normal playback, press ►|| again to play.

►Note:The sound is muted during still playback.

### (4).Locating a chapter or track

Press ►► (Skip Forward) or ◀◀ (Skip Reverse) during playback to locate a chapter that you want to watch. Each time you press the button, a chapter or track is skipped.

# PLAYING A DISC

## 3.DVD SETTINGS

Under DVD source, press **Setup** on remote control if you want to change the default DVD settings.



Selected item	Description
Down Mix	Select DVD Down Mix to Stereo or LT/RT.
Repeat	Press <b>ENTER</b> repeatedly to set "Chapter", "Title", "All" or "OFF".
Demo Mode	ON: 1.Skip the meun screen to playback.It will be convenient for display. 2.When you press "■Stop" during playback, the player will resume normal playback automatically after two seconds. OFF: Turn off "Demo Mode" function.
Subtitle	1. Press <b>ENTER</b> during playback. The current language will appear. 2. Press <b>ENTER</b> repeatedly until your desired language appears.
Autowake	ON: When the TV is off,if you load a disc,TV will power on and play the disc automatically. OFF: Turn off "Auto Wake" function.
Audio Select	1. Press <b>ENTER</b> during playback. The current soundtrack language will appear. 2. Press <b>ENTER</b> repeatedly until the desired language is selected.
Reset DVD	YES: Recall the factory default setting of DVD. NO : Remain the settings you did.

- The on screen display will disappear after a few seconds.

# MP3/WMA/JPEG CD Playback

This TV/DVD can playback the MP3/WMA/JPEG-data which has been recorded on CD-R or CD-RW. To produce the MP3/WMA/JPEG-data, you need a Windows-PC with CD-R/RW drive and a MP3/WMA/JPEG-encoding Software (not supplied). The Apple-HFS-System cannot be played.

► **Note:**

This TV/DVD requires discs/recordings to meet certain technical standards in order to achieve optimal playback quality. Pre-recorded DVDs are automatically set to these standards. There are many different types of recordable disc formats (including CD-R containing MP3/WMA files). Given the fact that technology in this area is still maturing. This unit cannot guarantee that all genre of recordable discs will produce optimal playback quality. The technical criteria set out in this owner's manual are meant as a guide only. Please be advised that you must obtain permission from the applicable copyright owners to download copyrighted content, including music files, in any format, including the MP3 and WMA formats, prior to the downloading thereof.

## 1. MP3/WMA/JPEG CD information

### Limitations on MP3/WMA/JPEG CD playback

- MP3/WMA/JPEG CD is the disc that is standardized by ISO9660, its file name must include 3-digits extension letters, "mp3", "wma", "jpg".
- MP3/WMA/JPEG CD must be correspond to the ISO standardized files.
- This TV/DVD can read 600 files per disc. If one directory has more than 600 files, the remaining files will be omitted.
- The unit is able to recognize up to a maximum of 50 directories per disc.
- MP3/WMA/JPEG CDs cannot be used for the purpose of recording.
- If the CD has both audio tracks and MP3/WMA/JPEG files, only audio tracks are played.
- It may take more than one minute for this unit to read MP3/WMA/JPEG files depending on its structure.
- Music recorded by "Joliet Recording Specification" can be played back, the file name is displayed (within 16 letters) on the screen. Long file names will be condensed.
- The music files recorded by "Hierarchical File System" (HFS) cannot be played.

### Limitations on display

- The maximum number for display is 16 letters.  
Available letters for display are the following: capital or small alphabets of A through Z, numbers of 0 through 9, and \_ (under score).
- Other letters than those above are replaced in hyphen.

### Notes on MP3/WMA/JPEG files

To playback MP3/WMA/JPEG CD in the recorded order.

1. Use MP3/WMA/JPEG software that records data alphabetically or numerically.
2. Name each file including two-digit or three-digit number (ex. "01" "02" or "001""002").
3. Refrain from making too many sub-folders.

### CAUTION:

- Some MP3/WMA/JPEG CDs cannot be played back depending on the recording conditions.
- The CD-R/RW that has no music data or non MP3/WMA/JPEG files cannot be played back.

# MP3/WMA/JPEG CD Playback

## Standard, sampling frequency, and the bit rate:

### MP3 CD

MPEG-1 Audio

32kHz, 44.1kHz, 48kHz

32kbps ~ 320 kbps (constant bit rate or variable bit rate)

The recommend recording setting for a high-quality sound is 44.1kHz of sampling frequency and 128kbps of constant bit rate.

### WMA CD

Upto 4kbps (bit rate)

The file recorded by mono, 48kHz, 48kbps is not available to this unit.

Microsoft, Windows Media, and the Windows Logo are either registered trademarks or trademarks of Microsoft Corporation in the United States and/or other countries.

## 2. MP3/WMA CD playback

- (1) Load a disc on which MP3 or WMA files has been recorded in the disc slot.
- (2) "READ" will appear on the TV screen.  
Reading time will depend on the number of files on the disc.
- (3) A file menu screen will appear on the screen. Playback begins automatically starting from the first file of first folder.
- (4) Press **▶/◀/▲/▼** or **ENTER** to select the desired folder.  
And then playback will begin automatically starting from the first file.
- (5) Press **■ STOP** to end playback.
  - The unit records the stopped point, depending on the disc.  
"▶■" appears on the screen. Press **▶|| PLAY** to resume playback from the scene point.
  - If you press **■ STOP** again ("■" appears on the screen.), the unit will clear the stopped point.
- (6) Press **▲ EJECT** to remove the disc.



## 3. JPEG CD playback

- (1) Load a disc on which JPEG files has been recorded in the disc slot.
- (2) "READ" will appear on the TV screen.  
Reading time will depend on the number of files on the disc.
- (3) A file menu screen will appear on the screen.
- (4) Press **▲/▼** to select the desired folder.
- (5) Press **▶** to preview the file.  
Press **▲/▼** and **ENTER** to select the desired file.
  - When **▶|| PLAY** has been pressed after displaying the file menu, playback begins automatically starting from the first file.Press "**■ STOP**" to return the file menu.
  - When **▶||** has been pressed after displaying the file menu, the next file will appear on the screen.Press "**■ STOP**" to return the preview mode. Press "**■ STOP**" again to return the file menu.
- (6) Press **▲ EJECT** to remove the disc.

# SPECIFICATIONS

Model Name		SK-26H590D	
Panel	Type	26" (26" viewable diagonal area), TFT (Thin Film Transistor), Active Matrix WXGA LCD, 1366 x 768 vertical stripe	
	Color	Anti-reflective coating < 2% reflection	
Viewing Angles		160° (H) / 150° (V)	
Input Signal	Video/Audio	VGA Analog * 1 (75 ohms, 0.7 Vp-p)/Mini-Stereo *1	
		H/V separated (TTL) for PC; fh: 30-49 kHz, fv: 50-75 Hz	
		HDMI-CP *1 / RCA (L/R) stereo *1	
		TV system antenna / NTSC & ATSC *1 in US	
		YPbPr * 2 / RCA (L/R) Stereo * 2	
Output Signal		Composite * 2 / S-Video * 2 / RCA (L/R) stereo * 2	
TV Compatibility		RCA (L/R) Stereo * 1; SPDIF (optical) *1	
TV Compatibility		480i, 480P, 720P, 1080i	
Video Engine			
The best TVs use the best technology: ATI inside your TV for The Ultimate Visual Experience™. Your new Westinghouse TV is powered by ATI's Xileon™ image processing chip for the true high definition cinematic experience. Enjoy your new Westinghouse TV with ATI inside.			
PC Compatible	Recommended	1360 x 768 @ 60Hz (reduced blanking), 1366 x 768 @ 60Hz (reduced blanking)	
	Supported	1280 x 720 @ 60 Hz    720 x 400 @ 70 Hz 1024 x 768 @ 60 Hz    640 x 480 @ 60, 75 Hz H = 30~49 KHz        V = 50~75 Hz	
DVD Player			
1. 12.7mm-high, Internal Type, Slot Load Mechanism 2. Support ISO/IEC 11172 MPEG-1, 13818 MPEG-2, 14496-2 MPEG-4 Video Sources 3. Support Dolby Digital, MPEG-I/II Layer 1/2, PCM, LPCM, WMA Audio Formats 4. Playback discs: DVD-Video, DVD-Audio, DVD+RW, DVD+R, DVD-RW, DVD-R, CD-DA, VCD, SVCD, ISO9600 (MP3, JPEG, WMA, MPEG4), CD-R, CD-RW 5. Disc Diameter : 12cm (can't support 8cm DISC)			
Speaker Output		9w ( x 2 Channels)	
Power	Voltage	120 VAC, 60 Hz, 2.0A	
Temperature (Note A)	Operating	0 to + 35° C (Hum.<90%)	
	Storage	-20 to +60° C (Hum.< 35%)	
Humidity (Relative). (Note A)	Operating	20 to 90% non-condensing. (Ta< 35%)	
	Storage	10 to 90% non-condensing. (Note A)	
Wet-bulb temperature should be 39°C Max. (Ta> 40°C) <i>Note A: The temperature and relative humidity range is shown in right side</i>			
Altitude	Operating	0 to 3,000 m	
	Storage	0 to 12,000m	
Dimensions	Physical	26.0" (W) x 19.8" (H) x 7.5" (D)	
Weight	Net / Gross	11.5 kg/ 14.0kg	
Regulations		UL/C-UL, FCC-B	
Consumption(DC Power)	On	<150w (Blue LED)	
	OFF in Normal (Autowake is on)	<23w (LED off)	
	OFF in Energy saving (Autowake is off)	<2w (LED off)	
	Power saving (Autowake is on)	<23w (Amber LED)	
<p><b>Preset Timing</b> (Pre-adjusted to reduce blanking: 1366 x 768 at 60Hz)</p> <p><b>Warning:</b> Do not set the graphics card in your computer to exceed these refresh rates; doing so may result in permanent damage to the LCD TV.</p>			

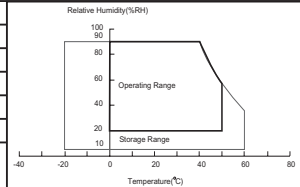

► Note: Product Specifications are subject to change without notice.

# SPECIFICATIONS

Model Name		SK-32H590D	
Panel	Type	32" (32" viewable diagonal area), TFT (Thin Film Transistor), Active Matrix WXGA LCD, 1366 x 768 vertical stripe	
	Color	Anti-reflective coating < 2% reflection	
Viewing Angles		176° (H) / 176° (V)	
Input Signal	Video/Audio	VGA Analog * 1 (75 ohms, 0.7 Vp-p)/Mini-Stereo *1	
		H/V separated (TTL) for PC; fh: 30-49 kHz, fv: 50-75 Hz	
		HDMI-CP *1 / RCA (L/R) stereo *1	
		TV system antenna / NTSC & ATSC *1 in US	
		YPbPr * 2 / RCA (L/R) Stereo * 2	
Output Signal		RCA (L/R) Stereo * 1; SPDIF (optical) *1	
TV Compatibility		480i, 480P, 720P, 1080i	
Video Engine		The best TVs use the best technology: ATI inside your TV for The Ultimate Visual Experience™. Your new Westinghouse TV is powered by ATI's Xileon™ image processing chip for the true high definition cinematic experience. Enjoy your new Westinghouse TV with ATI inside.	
PC Compatible	Recommended	1366 x 768 @ 60Hz (reduced blanking), 1366 x 768 @ 60Hz (reduced blanking)	
	Supported	1280 x 720 @ 60 Hz    720 x 400 @ 70 Hz 1024 x 768 @ 60 Hz    640 x 480 @ 60, 75 Hz H = 30-49 KHz        V = 50-75 Hz	
DVD Player		1. 12.7mm-high, Internal Type, Slot Load Mechanism 2. Support ISO/IEC 11172 MPEG-1, 13818 MPEG-2, 14496-2 MPEG-4 Video Sources 3. Support Dolby Digital, MPEG-I/II Layer 1/2, PCM, LPCM, WMA Audio Formats 4. Playback discs: DVD-Video, DVD-Audio, DVD+RW, DVD+R, DVD-RW, DVD-R, CD-DA, VCD, SVCD, ISO9600 (MP3, JPEG, WMA, MPEG4), CD-R, CD-RW 5. Disc Diameter : 12cm (can't support 8cm DISC)	
Speaker Output		9w ( x 2 Channels)	
Power	Voltage	120 VAC, 60 Hz, 2.5A	
Temperature (Note A)	Operating	0 to + 35° C (Hum.<90%)	
	Storage	-20 to +60°C (Hum.< 35%)	
Humidity (Relative). (Note A)	Operating	20 to 90% non-condensing. (Ta< 35%)	
	Storage	10 to 90% non-condensing. (Note A)	
Wet-bulb temperature should be 39°C Max. (Ta> 40°C)			
<i>Note A: The temperature and relative humidity range is shown in right side</i>			
Altitude	Operating	0 to 3,000 m	
	Storage	0 to 12,000m	
Dimensions	Physical	31.0" (W) x 23.5" (H) x 8.0" (D)	
Weight	Net / Gross	18.5 kg/ 21.0kg	
Regulations		UL/C-UL, FCC-B	
Consumption(DC Power)	On	<190w (Blue LED)	
	OFF in Normal (Autowake is on)	<23w (LED off)	
	OFF in Energy saving (Autowake is off)	<2w (LED off)	
	Power saving (Autowake is on)	<23w (Amber LED)	
<b>Preset Timing</b> (Pre-adjusted to reduce blanking: 1366 x 768 at 60Hz)			
<b>Warning:</b> Do not set the graphics card in your computer to exceed these refresh rates; doing so may result in permanent damage to the LCD TV.			

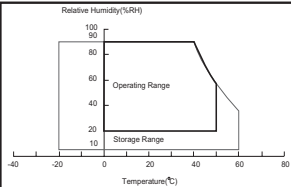

► Note: Product Specifications are subject to change without notice.

## •No Power

- Make sure power button is ON (Blue LED).
- Make sure AC power cord is securely connected to the AC socket.
- Plug another electrical device (such as a radio) to the power outlet to verify that the outlet is supplying the proper voltage.

## •Parental Control Password is “LOST”

- In the unlikely occurrence, select “ PASSWORD EDIT” and enter “0000” to reset the password.

## •AUDIO Interconnection Issues

- Remember that S-Video and Composite (VEDIO) share the same audio source.

## •Power is ON but No Screen Image

- Make sure the video cable connected to the DVD combo LCD TV is tightly secured to the video output port on the back of the computer. If the other end of the video cable is not attached properly to the DVD combo LCD TV, secure it tightly.
- Adjust brightness and contrast.
- If you are using a Macintosh computer older than G3, you need a Macintosh adapter.
- Check input source settings.

## •Wrong or Abnormal Colors

- If any colors (red, green, or blue) are missing, check the video cable to make sure it is connected securely. Loose or broken pins in the cable connector could cause an improper connection.
- Connect the DVD combo LCD TV to another computer.

## •Remote Control Buttons Do Not Work

- Press only one button at a time.
- Replace batteries.

## •Snow Appears on Screen

- Check your antenna connection.
- Check the TV / CATV selection.

## •No Sound

- Check the audio connection.
- Press MUTE on the remote control, so that MUTE disappears from the screen.
- Check the audio settings. The LCD TV audio may be set to SAP or minimum.
- Press the Volume + (Up) key on the remote control.
- Make sure that headphones are not connected to the Headphone Jack on the LCD TV.
- Make sure the speaker setting is set to “internal”.

## •Remote Control Does Not Work

- Make sure batteries are inserted correctly.
- Replace batteries with new ones if necessary.

## •Remote Control Code Not Found in a “Universal” Remote

- Purchase a separate “learning” remote control.

## •Image Quality Issues

- For the best TV image quality, “Standard Definition” TV should be viewed in 4:3 format.

## •DVD Player Does Not Work

Playback doesn’t start

- The disc is reversed. Load the disc with the playback side facing backward.
- No disc is loaded. Load the playable disc.
- The disc may be dirty. Clean the disc.

No picture / sound

- TV selector is not set correctly.
- Some discs may not perform certain functions.
- The setup may not match your TV system.

No subtitle

- Some discs have no subtitles.

## •How Can I Find More Help?

- Log on to: [www.westinghousedigital.com](http://www.westinghousedigital.com)
- Contact Westinghouse Customer Service at (866) 287-5555 or write us at [service@westinghousedigital.com](mailto:service@westinghousedigital.com)



# APPENDIX

## APPENDIX A: Remove the base

### Step-1

To lay the front bezel down on a soft and clear area, and please be sure that there is no any foreign object on it for avoiding any scratch or damage.

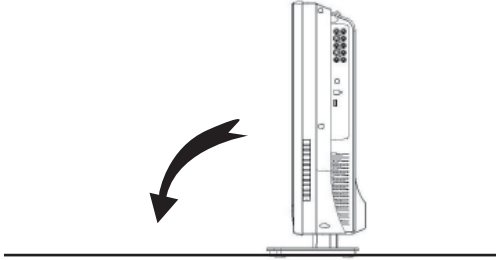

### Step-2

Remove the four screws as shown in the following illustration.

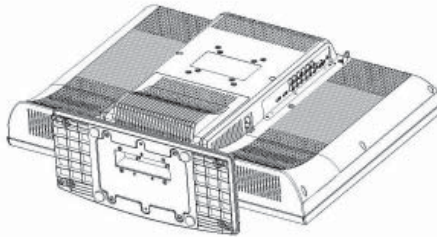

### Step-3

Remove the base from LCD TV.

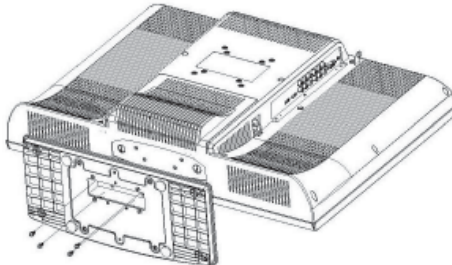

► Note:

- Be sure to turn off the LCD TV and disconnect all cables before detaching the base.
- The LCD TV has VESA® FPMPMIâ compliant 100x100mm and 75x75mm mounting holes.
- Be sure to follow the operating instructions supplied with the wall-mount bracket when installing the unit.
- Be sure to use qualified contractors, when installing or removing the TV on the wall.



[www.westinghousedigital.com](http://www.westinghousedigital.com)