

# Owner's Manual

## Integrated High Definition LCD Television

**42SL417U**

**46SL417U**

**55SL417U**

### Owner's Record

The model number and serial number are on the back and side of your TV. Record these numbers in the spaces below. Refer to these numbers whenever you communicate with your Toshiba dealer about this TV.

[www.support.toshiba.com](http://www.support.toshiba.com)

Model number:

Serial number:

For an overview of steps for setting up your new TV, see page 11.

Note: To display a High Definition picture, the TV must be receiving a High Definition signal (such as an over-the-air High Definition TV broadcast, a High Definition digital cable program, or a High Definition digital satellite program). For details, please contact your TV antenna installer, cable provider, or satellite provider.



## Dear Customer,

Thank you for purchasing this Toshiba LCD TV. This manual will help you use the many exciting features of your new LCD TV. **Before operating your LCD TV, please read this manual completely**, and keep it nearby for future reference.

### Safety Precautions

**WARNING: TO REDUCE THE RISK OF FIRE OR ELECTRIC SHOCK, DO NOT EXPOSE THIS APPLIANCE TO RAIN OR MOISTURE.**



**WARNING**  
RISK OF ELECTRIC SHOCK  
DO NOT OPEN.



**WARNING: TO REDUCE THE RISK OF ELECTRIC SHOCK, DO NOT REMOVE COVER (OR BACK). NO USER-SERVICEABLE PARTS INSIDE. REFER SERVICING TO QUALIFIED SERVICE PERSONNEL.**



The lightning flash with arrowhead symbol, within an equilateral triangle, is intended to alert the user to the presence of uninsulated "dangerous voltage" within the product's enclosure that may be of sufficient magnitude to constitute a risk of electric shock to persons.



The exclamation point within an equilateral triangle is intended to alert the user to the presence of important operating and maintenance (servicing) instructions in the literature accompanying the appliance.

### WARNING

To prevent injury, this apparatus must be securely attached to the floor/wall in accordance with the installation instructions. See item 26 on p. 4 and instructions on p. 5.

If television is not positioned in a sufficiently stable location, it can be potentially hazardous due to falling.

**WARNING:** If you decide to wall mount this television, always use a UL Listed wall bracket appropriate for the size and weight of this television. The use of any wall bracket other than a UL Listed wall bracket appropriate for the size and weight of this television for wall mounting this television could result in serious bodily injury and/or property damage. See "Removing the Pedestal Stand" (p. 6).

### NOTE TO CATV INSTALLERS

This is a reminder to call the CATV system installer's attention to Article 820-40 of the U.S. NEC, which provides guidelines for proper grounding and, in particular, specifies that the cable ground shall be connected to the grounding system of the building, as close to the point of cable entry as practical. For additional antenna grounding information, see items 34 and 35 on p. 4.

## CHILD SAFETY:

It Makes A Difference How and Where You Use Your Flat Panel Display

**Congratulations on your purchase! As you enjoy your new product, please keep these safety tips in mind:**

### The Issue

The home theater entertainment experience is a growing trend and larger flat panel displays are popular purchases. However, flat panel displays are not always supported on the proper stands or installed according to the manufacturer's recommendations.

- Flat panel displays that are inappropriately situated on dressers, bookcases, shelves, desks, speakers, chests or carts may fall over and cause injury.

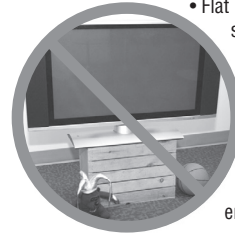

### TOSHIBA Cares!

- The consumer electronics industry is committed to making home entertainment enjoyable and safe.

### Tune Into Safety

- One size does NOT fit all. Follow the manufacturer's recommendations for the safe installation and use of your flat panel display.
- Carefully read and understand all enclosed instructions for proper use of this product.
- Don't allow children to climb on or play with furniture and television sets.
- Don't place flat panel displays on furniture that can easily be used as steps, such as a chest of drawers.
- Remember that children can become excited while watching a program, especially on a "larger than life" flat panel display. Care should be taken to place or install the display where it cannot be pushed, pulled over, or knocked down.
- Care should be taken to route all cords and cables connected to the flat panel display so that they cannot be pulled or grabbed by curious children.

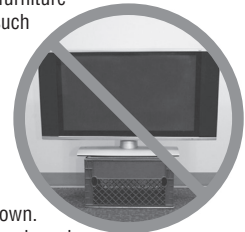

### Wall Mounting: If you decide to wall mount your flat panel display, always:

- Use a mount that has been recommended by the display manufacturer and/or listed by an independent laboratory (such as UL, CSA, ETL).
- Follow all instructions supplied by the display and wall mount manufacturers.
- If you have any doubts about your ability to safely install your flat panel display, contact your retailer about professional installation.
- Make sure that the wall where you are mounting the display is appropriate. Some wall mounts are not designed to be mounted to walls with steel studs or old cinder block construction. If you are unsure, contact a professional installer.
- A minimum of two people are required for installation. Flat panel displays can be heavy.



[www.CEA.org/safety](http://www.CEA.org/safety)

## Important Safety Instructions

- 1) **Read these instructions.**
  - 2) **Keep these instructions.**
  - 3) **Heed all warnings.**
  - 4) **Follow all instructions.**
- 
- 5) **Do not use this apparatus near water.**
- 
- 6) **Clean only with dry cloth.**
- 
- 7) **Do not block any ventilation openings.** Install in accordance with the manufacturer's instructions.
- 
- 8) **Do not install near any heat sources** such as radiators, heat registers, stoves, or other apparatus (including amplifiers) that produce heat.



- 9) **Do not defeat the safety purpose of the polarized or grounding type plug.** A polarized plug has two blades with one wider than the other. A grounding type plug has two blades and a third grounding prong. The wide blade or the third prong are provided for your safety. If the provided plug does not fit into your outlet, consult an electrician for replacement of the obsolete outlet.

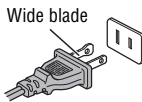

- 10) **Protect the power cord** from being walked on or pinched, particularly at plugs, convenience receptacles, and the point where they exit from the apparatus.

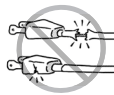

- 11) **Only use attachments/accessories specified by the manufacturer.**
- 
- 12) **Use only with the cart, stand, tripod, bracket, or table specified by the manufacturer, or sold with the apparatus.** When a cart is used, use caution when moving the cart/apparatus combination to avoid injury from tip-over.



- 13) **Unplug this apparatus during lightning storms or when unused for long periods of time.**
- 
- 14) **Refer all servicing to qualified service personnel.** Servicing is required when the apparatus has been damaged in any way, such as power-supply cord or plug is damaged, liquid has been spilled or objects have fallen into the apparatus, the apparatus has been exposed to rain or moisture, does not operate normally, or has been dropped.

## Additional Safety Precautions

- 14a) **CAUTION:** If the TV is dropped and the cabinet or enclosure surface has been damaged or the TV does not operate normally, take the following precautions:
  - ALWAYS turn off the TV and unplug the power cord to avoid possible electric shock or fire.
  - NEVER allow your body to come in contact with any broken glass or liquid from the damaged television. The LCD panel inside the TV contains glass and a toxic liquid. If the liquid comes in contact with your mouth or eyes, or your skin is cut by broken glass, rinse the affected area thoroughly with water and consult your doctor.



- ALWAYS contact a service technician to inspect the TV any time it has been damaged or dropped.

- 15) **CAUTION:**
    - To reduce the risk of electric shock, do not use the polarized plug with an extension cord, receptacle, or other outlet unless the blades can be inserted completely to prevent blade exposure.
    - To prevent electric shock, match wide blade of plug to wide slot; fully insert.
- 
- 16) **CAUTION:** Do not let children swallow the product or play with the plastic bag. Keep the product and the plastic bag out of the reach of children.
- 
- 17) **CAUTION:** Do not let water or other liquids come into contact with the product, as it may result in damage.
- 
- 18) **WARNING:**
    - To prevent the spread of fire, keep candles or other open flames away from this product at all times.
    - Keep the product away from direct sunlight, fire or a heat source such as a heater. This may reduce the product lifetime or result in fire.

## Installation, Care, and Service

### Installation

Follow these recommendations and precautions and heed all warnings when installing your TV:

- 19)  **WARNING: NEVER expose batteries to excessive heat such as sunshine, fire, or the like.**
- 
- 20) ALWAYS plug the product into an outlet that is located in such a manner that it can be easily unplugged in case the product requires service.
- 
- 21) NEVER route the product's power cord inside a wall or similar enclosed area.
- 
- 22) Never modify this equipment. Changes or modifications may void: a) the warranty, and b) the user's authority to operate this equipment under the rules of the Federal Communications Commission.
- 
- 23)  **DANGER: RISK OF SERIOUS PERSONAL INJURY, DEATH, OR EQUIPMENT DAMAGE!** 

Never place the TV on an unstable cart, stand, or table. The TV may fall, causing serious personal injury, death, or serious damage to the TV.
- 
- 24) To avoid damage to this product, never place or store the TV in direct sunlight; hot, humid areas; or areas subject to excessive dust or vibration.
- 
- 25) Never place the TV in an unstabilized location such as on a shaky table, incline or location subject to vibration.
    - Only use cabinets fit for such purpose or stands recommended by the manufacturer of the TV.
    - Only use furniture that can safely support the TV.

- Ensure that the TV is not hanging over the edge of the supporting furniture.
- Never place the TV on tall furniture (for example, cupboards or bookcases) without anchoring both the furniture and the TV to a suitable support
- Never stand the TV on cloth or other material placed between the TV and supporting furniture.

The TV may drop or fall off which may cause an injury or damage.

- 26) Always place the TV on the floor or a sturdy, level, stable surface that can support the weight of the unit. In order to maintain stability and prevent the TV from falling over, secure the TV by either of the methods below:

- Secure the TV with the supplied mounting screw. (recommended)  
Place the TV on a sturdy surface that has a sufficient thickness and screw the unit on the surface securely by using the mounting screw and the fall-prevention screw hole.

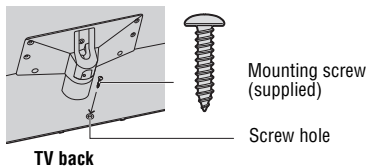

- Secure the TV with the securement clip and a sturdy strap from the hooks on the rear of the TV pedestal to a wall stud, pillar, or other immovable structure. Make sure the strap is tight, secure, and parallel to the floor.

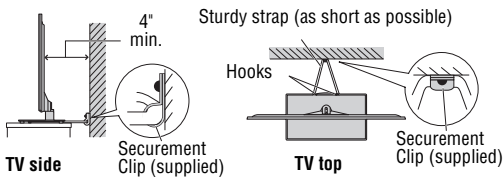

- 27) Never stand or climb on the TV.

- Educate children about the dangers of climbing on furniture to reach the TV or its controls.

Be especially careful in households with children to prevent them though climbing on top of the TV. It may move, fall over, break, become damaged or cause an injury.



- 28) The apparatus shall not be exposed to dripping or splashing, and that no objects filled with liquids, such as vases, shall be placed on the apparatus.

- 29) Never block or cover the slots or openings in the TV cabinet back, bottom, and sides. Never place the TV:

- on a bed, sofa, rug, or similar surface;
- too close to drapes, curtains, or walls; or
- in a confined space such as a bookcase, built-in cabinet, or any other place with poor ventilation.



The slots and openings are provided to protect the TV from overheating and to help maintain reliable operation of the TV. Leave a space of at least 4 (four) inches around the TV.

- 30) Always place the back of the television at least 4 (four) inches away from any vertical surface (such as a wall) to allow proper ventilation.

- 31) Never allow anything to rest on or roll over the power cord, and never place the TV where the power cord is subject to wear or abuse.

- 32) Never overload wall outlets and extension cords.

- 33) Always operate this equipment from a 120 VAC, 60 Hz power source only.

- 34) Always make sure the antenna system is properly grounded to provide adequate protection against voltage surges and built-up static charges (see Section 810 of the National Electric Code).

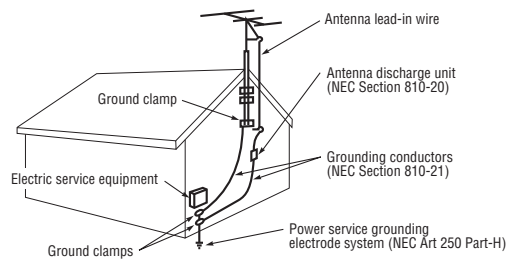

- 35)



**DANGER: RISK OF SERIOUS PERSONAL INJURY OR DEATH!**

- Use extreme care to make sure you are never in a position where your body (or any item you are in contact with, such as a ladder or screwdriver) can accidentally touch overhead power lines. Never locate the antenna near overhead power lines or other electrical circuits.
- Never attempt to install any of the following during lightning activity: a) an antenna system; or b) cables, wires, or any home theater component connected to an antenna or phone system.

**Care**

For better performance and safer operation of your TOSHIBA TV, follow these recommendations and precautions:

- 36) If you use the TV in a room whose temperature is 32 °F (0 °C) or below, the picture brightness may vary until the LCD warms up. This is not a sign of malfunction.

- 37) Always unplug the TV before cleaning. When cleaning your TV, please first remove any dirt or dust from the surface. Gently wipe the cabinet and the display panel surface (the TV screen) with a dry, soft cloth (cotton, flannel, etc.). Harsh rubbing or use of a dirty or stiff cloth will scratch the TV surface. Avoid contact with alcohol, thinner, benzene, acidic or alkaline solvent cleaners, abrasive cleaners, or chemical cloths, which may damage the TV surface. Never spray





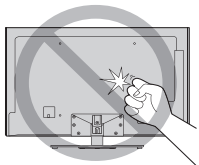

volatile compounds such as insecticide on the TV surface. Such products may damage or discolor the TV.

- 38) Never hit, press, or place anything on the back cover. These actions will damage internal parts.





- 39)  **WARNING: RISK OF ELECTRIC SHOCK!**   
Never spill liquids or push objects of any kind into the TV cabinet slots.

- 40) During a lightning storm, do not touch the connecting cables or TV set.
- 41) For added protection of your TV from lightning and power surges, always unplug the power cord and disconnect the antenna from the TV if you leave the TV unattended or unused for long periods of time.
- 42) ALWAYS unplug the TV to completely disconnect from main power. When the TV is turned off using the on/off switch, it is not completely disconnected from power and a minute amount of current is still consumed.
- 43) During normal use, the TV may make occasional snapping or popping sounds. This is normal, especially when the unit is being turned on or off. If these sounds become frequent or continuous, unplug the power cord and contact a Toshiba Authorized Service Provider.

- 44)  **WARNING: RISK OF SERIOUS PERSONAL INJURY OR EQUIPMENT DAMAGE!**   
Never strike the screen with a sharp or heavy object.

- 45) • The LCD screen of this product can be damaged by ultraviolet radiation from the sun. When selecting a location for the television, avoid locations where the screen may be exposed to direct sunlight, such as in front of a window.
- Never touch, press, or place anything on the LCD screen. These actions will damage the LCD screen. If you need to clean the LCD screen, follow the instructions in item 37 on p. 4.

## Service

- 46)  **WARNING: RISK OF ELECTRIC SHOCK!**   
Never attempt to service the TV yourself. Opening and removing the covers may expose you to dangerous voltage or other hazards. Failure to follow this WARNING may result in death or serious injury. Refer all servicing not specified in this manual to a Toshiba Authorized Service Provider.

- 47) If you have the TV serviced:
- Ask the service technician to use only replacement parts specified by the manufacturer.
  - Upon completion of service, ask the service technician to perform routine safety checks to determine that the TV is in safe operating condition.

## Choosing a location for your LCD TV

### To Display your LCD TV on the included Pedestal Stand:

Observe the following safety precautions:

- 1) Read and Follow the pedestal assembly instructions included with the pedestal.  
**CAUTION:** Before beginning pedestal assembly, carefully lay the front of the LCD Panel face down on a flat, cushioned surface such as a quilt or blanket. Leave the bottom of the unit protruding over the edge of the surface and assemble the pedestal as indicated below.  
**Note:** *Extreme care should always be used when attaching the pedestal stand to avoid damage to the LCD panel.*
- 2) Place the TV on a sturdy, level surface that can support the weight of the TV.
- 3) Be sure to secure the TV to a wall stud, pillar, surface, or other immovable structure. To secure the TV in this manner: (1) attach the provided securement clip to an immovable structure, then (2) pass a sturdy strap through the securement clip and attach each end to the hooks located on the back of the TV. Be sure to leave at least 4 inches between the TV and the wall or similar structure for ventilation. See item 26, p. 4 for additional details.

### To Display your LCD TV using a Wall Bracket:

If you decide to wall mount your LCD TV, always use a UL Listed wall bracket appropriate for the size and weight of the LCD TV (see p. 2) :

#### CAUTION:

1. Two people are required for installation.
2. Never use the screws attached to the TV.
3. To install a wall-mount from another manufacturer, use the enclosed SPACERS.
  - 1) Unplug and remove any cables and/or other component connectors from the rear of the TV.
  - 2) Carefully lay the front of the unit face down on a flat, cushioned surface such as a quilt or blanket.
  - 3) Follow the instructions provided with your wall bracket. Before proceeding, make sure the appropriate bracket(s) are attached to the wall and the back of the TV as described in the instructions provided with the wall bracket.
  - 4) Make sure to place the spacers provided with the TV between the bracket and the back of the TV.
  - 5) Always use the screws supplied or recommended by the wall mount manufacturer.

# USA - Federal Communications Commission Statement

## FCC Compliance Statement

**Toshiba television models 42SL417U, 46SL417U, and 55SL417U** comply with Part 15 of the FCC Rules.

Operation is subject to the following two conditions:

- (1) This device may not cause harmful interference, and
- (2) This device must accept any interference received, including interference that may cause undesired operation.

The party responsible for compliance to these rules is:

Toshiba America Information Systems, Inc.

9740 Irvine Blvd., Irvine, CA 92618.

Ph: 1-800-631-3811

**Interference:** This equipment has been tested and found to comply with the limits for a Class B digital device, pursuant to Part 15 of the FCC Rules. These limits are designed to provide reasonable protection against harmful interference in a residential installation.

This equipment generates, uses, and can radiate radio frequency energy and, if not installed and used in accordance with the instructions, may cause harmful interference to radio communications. However, there is no guarantee that interference will not occur in a particular installation. If this equipment does cause harmful interference to radio or television reception, which can be determined by turning the equipment off and on, the user is encouraged to try to correct the interference by one of the following measures:

- Reorient or relocate the receiving antenna.
- Increase the separation between the equipment and receiver.
- Connect the equipment into an outlet on a circuit different from that to which the receiver is connected.
- Consult the dealer or an experienced radio/TV technician for help.

## Wireless Radio

For product available in the USA/Canada market, only channel 1–11 can be operated. Selection of other channels is not possible.

The device could automatically discontinue transmission in case of absence of information to transmit, or operational failure. Note that this is not intended to prohibit transmission of control or signaling information or the use of repetitive codes where required by the technology.

If this device is going to be operated in 5.15–5.25GHz frequency range, then it is restricted to an indoor environment only.

**Important:** Any changes or modifications not expressly approved by the party responsible for compliance could void the user's authority to operate this equipment.

This device and its antenna(s) must not be co-located or operating in conjunction with any other antenna or transmitter.

**FCC Radiation Exposure Statement:** This equipment complies with FCC radiation exposure limits set forth for an uncontrolled environment. This equipment should be installed and operated with minimum distance 20cm between the radiator & your body.

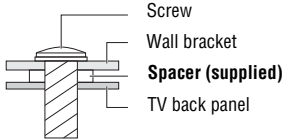
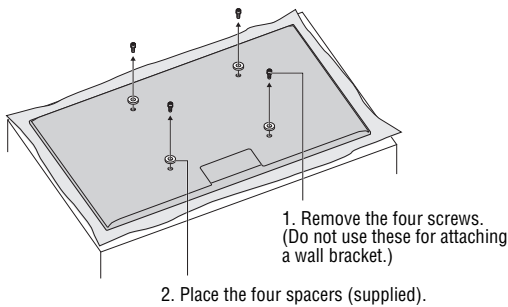

## Removing the Pedestal Stand

- 1) Carefully lay the front of the unit face down on a flat, cushioned surface such as a quilt or blanket. Leave the stand protruding over the edge of the surface.

**Note:** Extreme care should always be used when removing the pedestal stand to avoid damage to the LCD panel.

- 2) Remove the seven screws.
- 3) Once you have removed all seven screws holding the pedestal stand in place, remove the pedestal stand from the TV by sliding the pedestal stand away from the TV.

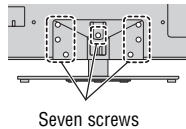

## Canada - Industry Canada Statement

This device complies with RSS-210.

Operation is subject to the following two conditions:

- (1) This device may not cause harmful interference, and
- (2) This device must accept any interference received, including interference that may cause undesired operation of the device.

This device and its antenna(s) must not be co-located or operating in conjunction with any other antenna or transmitter.

### Wireless Radio

For product available in the USA/Canada market, only channel 1–11 can be operated. Selection of other channels is not possible.

The device could automatically discontinue transmission in case of absence of information to transmit, or operational failure. Note that this is not intended to prohibit transmission of control or signaling information or the use of repetitive codes where required by the technology.

**Important:** Any changes or modifications not expressly approved by the party responsible for compliance could void the user's authority to operate this equipment.

### IMPORTANT NOTE:

*IC Radiation Exposure Statement: This equipment complies with IC RSS-102 radiation exposure limits set forth for an uncontrolled environment. This equipment should be installed and operated with minimum distance 20cm between the radiator & your body.*

## ENERGY STAR® User Information

ENERGY STAR User Information Statement: the factory default settings of this television meet ENERGY STAR® requirements. Enabling or changing certain features and functionality (e.g. Picture Settings, Auto Brightness Sensor) may increase energy consumption, possibly beyond the limits required for ENERGY STAR qualification.

To ensure your television is operating at optimal energy efficiency, select [Home] mode during initial activation. To return to [Home] mode settings, select [AutoView] picture mode, and set Auto Brightness Sensor to [On] mode.

[AutoView] mode is recommended for normal home use. For more information, see p. 48.



ENERGY STAR® qualified TV. Products that earn the ENERGY STAR prevent green house gas emissions by meeting strict guidelines set by the U.S. Environmental Protection Agency. ENERGY STAR and the ENERGY STAR mark are registered U.S. marks.

## Important notes about your LCD TV

The following symptoms are technical limitations of LCD Display technology and are not an indication of malfunction; therefore, Toshiba is not responsible for perceived issues resulting from these symptoms.

- 1) An afterimage (ghost) may appear on the screen if a fixed, non-moving image is displayed for a long period of time. The afterimage is not permanent and will disappear in a short period of time.
- 2) The LCD panel contained in this TV is manufactured using an extremely high level of precision technology; however, there may be an occasional pixel (dot of light) that does not operate properly (does not light, remains constantly lit, etc.). This is a structural property of LCD technology, is not a sign of malfunction, and is not covered under your warranty. Such pixels are not visible when the picture is viewed from a normal viewing distance.

**Note:** Interactive video games that involve shooting a "gun" type of joystick at an on-screen target may not work with this TV.

## Trademark Information

- **DOLBY DIGITAL PLUS** Manufactured under license from Dolby Laboratories. Dolby and the double-D symbol are registered trademarks of Dolby Laboratories.
- **AUDYSSEY DYNAMIC VOLUME** Audyssey Dynamic Volume® controls volume levels to eliminate loud spikes and raise soft dialog for more enjoyable television and movie viewing. Audyssey EQ® provides clear, accurate and natural sound right out of the box. Together, these technologies ensure you enjoy your audio experience as much as your video.
- Manufactured under license from Audyssey Laboratories. U.S. and foreign patents pending. Audyssey EQ and Audyssey Dynamic Volume are registered trademarks of Audyssey Laboratories.
- **HDMI** HDMI, the HDMI Logo, and High-Definition Multimedia Interface are trademarks or registered trademarks of HDMI Licensing LLC in the United States and other countries.
- Blu-ray Disc™, Blu-ray™, and the logos are trademarks of the Blu-ray Disc Association.
- INSTAPORT™ and INSTAPORT logo are trademarks of Silicon Image, Inc. in the United States and other countries.
- MPEG Layer-3 audio coding technology licensed from Fraunhofer IIS and Thomson.
- DLNA®, DLNA® Certification Logo, and DLNA CERTIFIED™ are registered trademarks, trademarks, service marks, or certification marks of the Digital Living Network Alliance.
- VUDU is a trademark of VUDU, Inc .
- YouTube is a registered trademark of Google, Inc.
- Netflix is a registered trademark of Netflix, Inc.
- Yahoo! is a registered trademark of Yahoo! Inc.
- CinemaNow is a registered trademark of Best Buy, Inc.
- Pandora is a registered trademark of Pandora Media, Inc.
- Blockbuster is a registered trademark of Blockbuster, Inc.
- This product contains Adobe® Flash® Player software under license from Adobe Systems Incorporated. Copyright © 1995-2009 Adobe Systems Incorporated. All rights reserved. Adobe and Flash are trademarks of Adobe Systems Incorporated.
- This product contains technology subject to certain intellectual property rights of Microsoft. Use or distribution of this technology outside of this product is prohibited without the appropriate license(s) from Microsoft.
- This product includes technology owned by Microsoft Corporation and can not be used or distributed without a license from Microsoft Licensing, GP.
- THIS PRODUCT IS LICENSED UNDER THE AVC PATENT PORTFOLIO LICENSE FOR THE PERSONAL AND NON-COMMERCIAL USE OF A CONSUMER TO (i) ENCODE VIDEO IN COMPLIANCE WITH THE AVC STANDARD (“AVC VIDEO”) AND/OR (ii) DECODE AVC VIDEO THAT WAS ENCODED BY A CONSUMER ENGAGED IN A PERSONAL AND NON-COMMERCIAL ACTIVITY AND/OR WAS OBTAINED FROM A VIDEO PROVIDER LICENSED TO PROVIDE AVC VIDEO. NO LICENSE IS GRANTED OR

SHALL BE IMPLIED FOR ANY OTHER USE. ADDITIONAL INFORMATION MAY BE OBTAINED FROM MPEG LA,LLC. SEE [HTTP://WWW.MPEGLA.COM](http://www.mpegla.com)

- THIS PRODUCT IS LICENSED UNDER THE VC-1 PATENT PORTFOLIO LICENSE FOR THE PERSONAL AND NON-COMMERCIAL USE OF A CONSUMER TO (i) ENCODE VIDEO IN COMPLIANCE WITH THE VC-1 STANDARD (“VC-1 VIDEO”) AND/OR (ii) DECODE VC-1 VIDEO THAT WAS ENCODED BY A CONSUMER ENGAGED IN A PERSONAL AND NON-COMMERCIAL ACTIVITY AND/OR WAS OBTAINED FROM A VIDEO PROVIDER LICENSED TO PROVIDE VC-1 VIDEO. NO LICENSE IS GRANTED OR SHALL BE IMPLIED FOR ANY OTHER USE. ADDITIONAL INFORMATION MAY BE OBTAINED FROM MPEG LA,LLC. SEE [HTTP://WWW.MPEGLA.COM](http://www.mpegla.com)
- THIS PRODUCT IS LICENSED UNDER THE MPEG-4 VISUAL PATENT PORTFOLIO LICENSE FOR THE PERSONAL AND NON-COMMERCIAL USE OF A CONSUMER FOR (i) ENCODING VIDEO IN COMPLIANCE WITH THE MPEG-4 VISUAL STANDARD (“MPEG-4 VIDEO”) AND/OR (ii) DECODING MPEG-4 VIDEO THAT WAS ENCODED BY A CONSUMER ENGAGED IN A PERSONAL AND NON-COMMERCIAL ACTIVITY AND/OR WAS OBTAINED FROM A VIDEO PROVIDER LICENSED BY MPEG LA TO PROVIDE MPEG-4 VIDEO. NO LICENSE IS GRANTED OR SHALL BE IMPLIED FOR ANY OTHER USE. ADDITIONAL INFORMATION INCLUDING THAT RELATING TO PROMOTIONAL, INTERNAL AND COMMERCIAL USES AND LICENSING MAY BE OBTAINED FROM MPEG LA,LLC. SEE [HTTP://WWW.MPEGLA.COM](http://www.mpegla.com)

# Contents

|  |           |
|--|-----------|
| <b>Important Safety Instructions</b> .....                               | <b>3</b>  |
| <b>Installation, Care, and Service</b> .....                             | <b>3</b>  |
| <b>Choosing a location for your LCD TV</b> .....                         | <b>5</b>  |
| <b>Chapter 1: Introduction</b> .....                                     | <b>11</b> |
| Features .....   | 11        |
| Overview of installation, setup, and use .....                           | 11        |
| Front panel control .....  | 12        |
| Back panel connections .....   | 12        |
| Bundling the cables .....  | 13        |
| <b>Chapter 2: Connecting your TV</b> .....                               | <b>14</b> |
| Overview of cable types .....  | 14        |
| About the illustrations .....  | 14        |
| Connecting to a Satellite dish, an Antenna, or Cable TV .....            | 15        |
| Connecting an HDMI® or DVI device to the HDMI input .....                | 16        |
| Connecting a VCR or DVD player with ColorStream® (component video) ..... | 17        |
| Connecting a digital audio system .....                                  | 18        |
| Using the TV remote and HDMI® CEC Control to control other devices ..... | 19        |
| Connecting an HDMI audio system .....                                    | 19        |
| Connecting a PC .....  | 20        |
| Connecting to a home network .....                                       | 21        |
| <b>Chapter 3: Using the remote control</b> .....                         | <b>22</b> |
| Controlling other devices .....  | 22        |
| Installing batteries .....   | 22        |
| Learning about the Remote Control .....                                  | 23        |
| <b>Chapter 4: Initial Setup and Menu</b> .....                           | <b>24</b> |
| Initial Setup .....  | 24        |
| Navigating the menu system .....   | 25        |
| Main menu layout .....   | 26        |
| Quick menu .....   | 27        |
| <b>Chapter 5: Setting up your TV</b> .....                               | <b>28</b> |
| Changing Initial settings .....  | 28        |
| Menu language .....  | 28        |
| Local Time Setting .....   | 28        |
| Location .....   | 28        |
| ANT/CABLE IN .....   | 28        |
| Storing channels in memory (optional) .....                              | 28        |
| Auto Tuning .....  | 28        |
| Manual Tuning .....  | 29        |
| Skipping channels .....  | 29        |
| Skipping video inputs .....  | 29        |
| Labeling channels .....  | 30        |
| Labeling video inputs .....  | 30        |
| Configuring shared inputs .....  | 30        |
| Setting the Auto Input feature .....                                     | 31        |
| <b>Chapter 6: Basic features</b> .....                                   | <b>32</b> |
| Tuning channels .....  | 32        |
| Setting the Channel Tuning Mode .....                                    | 32        |
| Tuning in to the next programmed channel .....                           | 32        |
| Tuning in to a specific channel (programmed or unprogrammed) .....       | 32        |
| Using the Channel Browser™ .....   | 32        |
| Using Channel Return .....   | 34        |
| Using SurfLock™ .....  | 34        |
| Selecting the video input to view .....                                  | 34        |
| Using closed captions .....  | 35        |
| Analog CC mode .....   | 35        |
| Digital CC settings .....  | 35        |
| Setting the PIN code .....   | 36        |
| Entering a new PIN code .....  | 36        |
| Changing or deleting your PIN code .....                                 | 36        |
| Forgotten PIN code .....   | 36        |
| Using parental controls .....  | 36        |
| Blocking TV programs and movies by rating (V-Chip) .....                 | 36        |
| Downloading an additional rating system .....                            | 37        |
| Displaying ratings .....   | 38        |
| Unlocking programs .....   | 38        |
| Locking specific channels .....  | 38        |
| Locking video input .....  | 38        |
| Setting a time limit for games .....                                     | 39        |
| Locking the control panel .....  | 39        |
| Using HDMI® CEC Control .....  | 39        |
| Controlling HDMI® CEC playback devices .....                             | 40        |
| HDMI® CEC Control input source selection .....                           | 40        |
| Adjusting the amplifier's audio .....                                    | 41        |
| Other HDMI® CEC Control functions .....                                  | 41        |
| Using the HDMI® settings feature .....                                   | 41        |
| Viewing the HDMI® signal information .....                               | 41        |
| Using your PC with the TV .....  | 42        |
| Adjusting the image .....  | 42        |
| Setting the PC audio .....   | 42        |
| Setting the timer to turn on the TV .....                                | 42        |
| Setting the sleep timer .....  | 43        |
| Setting Automatic Power Down .....                                       | 43        |
| Setting No Signal Power Down .....                                       | 43        |
| Displaying TV status information .....                                   | 44        |
| Viewing support information .....  | 44        |
| Resetting to Factory Defaults .....                                      | 44        |
| Power failure .....  | 44        |
| <b>Chapter 7: Picture and sound controls</b> .....                       | <b>45</b> |
| Selecting the picture size .....   | 45        |
| Scrolling the picture .....  | 47        |
| Using the Auto Aspect feature .....                                      | 47        |
| Using the 4:3 Stretch .....  | 47        |
| Freezing the picture .....   | 47        |
| Adjusting the picture .....  | 48        |
| Selecting the picture mode .....   | 48        |
| Adjusting the picture quality .....                                      | 48        |
| Using the advanced picture settings features .....                       | 49        |
| Edge Enhancer .....  | 49        |
| Dynamic Contrast .....   | 49        |
| DynaLight™ .....   | 49        |
| Static Gamma .....   | 49        |
| Film Stabilization .....   | 49        |
| ClearFrame™ feature .....  | 50        |
| MPEG NR .....  | 50        |
| DNR .....  | 50        |
| Auto Brightness Sensor .....   | 50        |
| Backlight Adjustment Pro .....   | 50        |
| ColorMaster™ .....   | 51        |
| Base Color Adjustment .....  | 51        |
| Color temperature .....  | 51        |
| Resetting to the factory default .....                                   | 51        |
| Setting the Expert Picture Settings .....                                | 51        |
| Test Pattern .....   | 51        |
| RGB Filter .....   | 51        |
| White Balance .....  | 51        |
| Resetting to the factory default .....                                   | 52        |
| Locking the picture settings .....                                       | 52        |
| Adjusting the audio .....  | 52        |
| Muting the sound .....   | 52        |

|   |           |
|---|-----------|
| Selecting stereo/SAP broadcasts .....                                       | 52        |
| Adjusting the audio balance .....   | 53        |
| Adjusting the range .....   | 53        |
| Selecting the optical audio output format .....                             | 53        |
| Using the Dolby® Digital Dynamic Range Control<br>feature .....             | 53        |
| Using Audyssey Dynamic Volume® .....  | 53        |
| Using advanced sound features .....   | 54        |
| Using surround sound .....  | 54        |
| <b>Chapter 8: Advanced features .....</b>                                   | <b>55</b> |
| Using your home network .....   | 55        |
| Setting up the Network .....  | 56        |
| Wireless Setup .....  | 56        |
| Advanced Network Setup .....  | 58        |
| Network Connection Test .....   | 59        |
| Using the software keyboard .....   | 59        |
| Performing a Software Upgrade .....   | 60        |
| Viewing the Software Licenses .....   | 60        |
| Using the NET TV™ feature .....   | 60        |
| NET TV menu .....   | 60        |
| Netflix .....   | 61        |
| VUDU™ .....   | 61        |
| YouTube™ .....  | 61        |
| CinemaNow .....   | 62        |
| Blockbuster .....   | 62        |
| Pandora .....   | 62        |
| Yahoo!® TV Widgets .....  | 62        |
| Using the Media Player .....  | 64        |
| Media Player Specifications .....   | 64        |
| Basic operation .....   | 64        |
| Viewing Movie files .....   | 65        |
| Playing Music file .....  | 66        |
| Viewing Photo files .....   | 67        |
| Using the Wallpaper feature .....   | 69        |
| <b>Chapter 9: Troubleshooting .....</b>                                     | <b>70</b> |
| General troubleshooting .....   | 70        |
| LED indications .....   | 72        |
| <b>Chapter 10: Appendix .....</b>   | <b>73</b> |
| Specifications .....  | 73        |
| Acceptable signal formats for PC IN and HDMI<br>terminals .....             | 75        |
| PC IN signal formats .....  | 75        |
| HDMI signal formats .....   | 76        |
| Remote control functional key chart .....                                   | 77        |
| Operating other devices .....   | 79        |
| Programming the remote to operate other devices .....                       | 79        |
| Device code setup .....   | 79        |
| Searching for a device code .....   | 80        |
| Locking the volume keys .....   | 80        |
| Clearing the remote's programming .....                                     | 80        |
| Resetting to the factory default .....                                      | 80        |
| Operating the TV with combination buttons .....                             | 81        |
| Remote control codes .....  | 82        |
| Limited United States Warranty<br>for LCD Televisions .....                 | 88        |
| Limited Canadian Warranty<br>for Toshiba Brand Flat Panel Televisions ..... | 89        |
| <b>Index .....</b>  | <b>92</b> |





# Chapter 1: Introduction

## Features

- **Integrated digital tuning (8VSB ATSC and QAM)** eliminates the need for a separate digital converter set-top box (in most cases).
- **1080p output resolution.**
- **Four HDMI® digital, High-Definition Multimedia Interfaces** with 1080p input support (see p. 16).
- **HDMI capabilities**
  - ARC (Audio Return Channel)** enables the audio signal of the TV to be sent to an AV amplifier via an HDMI cable.
  - HDMI INSTAPORT™** technology reduces lag time when switching HDMI sources.
  - RGB Range** adjusts RGB full range signal automatically.
- **HDMI® CEC Control** allows control of external devices from the TV remote via HDMI connection (see p. 39).
- **ColorStream® HD** high-resolution component video input.
- **Digital Audio Out** optical audio connection with Dolby® Digital optical output format (see p. 53).
- **PC IN (Analog RGB)** computer terminal (see p. 20).
- **Built-in WLAN** Allows the television to access your home wireless network without an external Dual Band WLAN Adapter.
- **Yahoo!® TV Widgets** are Internet applications designed to run on your TV (see p. 62).
- **ColorMaster™** lets you adjust the TV's standard colors (see p. 51).
- **ClearFrame™** 120 Hz anti-blur feature (see p. 50).
- **AutoView®** lets you automatically adjust picture settings based on ambient light conditions and input signal content (see p. 48).
- **Dynamic Volume (Audyssey Dynamic Volume®)** eliminates inconsistent TV volume when changing channels or viewing commercials (see p. 53).
- **Media Player** lets you view photo files and play music or movie files (see p. 64).



**ENERGY STAR® qualified**

## Overview of installation, setup, and use

Follow these steps to set up your TV and begin using its many exciting features.

- 1 To choose a location for the TV:
  - Read "Important notes about your LCD TV" (see p. 7).
  - Place the TV in an appropriate location (see p. 2–6).
- 2 Do not plug in any power cords until AFTER you have connected all cables and devices to your TV.
- 3 BEFORE connecting cables or devices to the TV, learn the functions of the TV's connections and controls (see p. 12).
- 4 Connect your other electronic device(s) to the TV (see p. 14–21).
- 5 See "Chapter 3: Using the remote control" (see p. 22) for an overview of the buttons on the remote control, installing the batteries, and preparing to operate your other device(s).
- 6 AFTER connecting all cables and devices, plug in the power cords for your TV and other devices. When you turn on the TV, the Initial Setup menu appears.
- 7 See "Chapter 4: Initial Setup and Menu" for a quick overview of navigating the TV's menu system (see p. 24).
- 8 Program channels into the TV's channel memory (see p. 28).
- 9 See Chapters 6, 7 and 8, for details on using the TV's features.
- 10 For help, refer to "Chapter 9: Troubleshooting" (see p. 70).
- 11 See "Chapter 10: Appendix", for technical specifications and warranty information (see p. 73).

## Front panel control

Examples show Model 42SL417U.

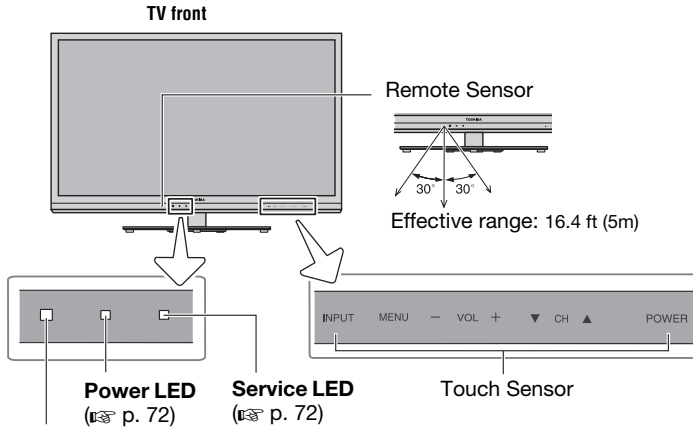

### Brightness Sensor

This sensor will detect the ambient light conditions to optimize the backlighting levels (refer to page 50).

### Touch key function:

– These are available when touched.

- **POWER** – To turn the TV on and off.
- **▲ ▼** – To change the channel. When a menu is onscreen, these keys function as up/down menu navigation buttons.
- **+ -** – To adjust the volume level. When a menu is onscreen, these keys function as left/right menu navigation buttons.
- **MENU** – To access the menu. When a menu is onscreen, the MENU key on the TV's control panel functions as the RETURN button.
- **INPUT** – To change the source you are viewing. When a menu is onscreen, the INPUT key on the TV's control panel functions as the OK button.

## Back panel connections

For explanations of cable types and connections, see p. 14–21.

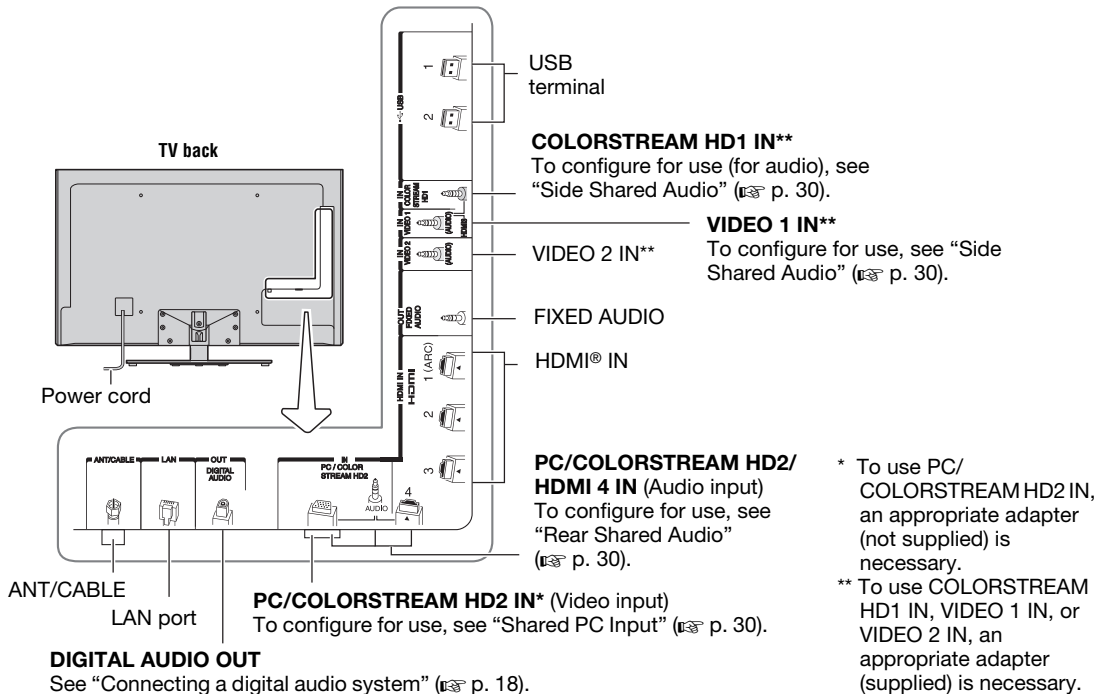

## Bundling the cables

Install the cable clamps and bundle the cables in them.

### Stand type

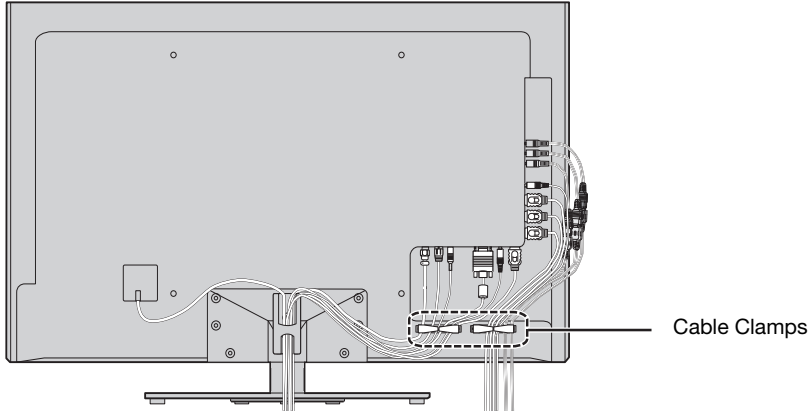

### Wall Mount type

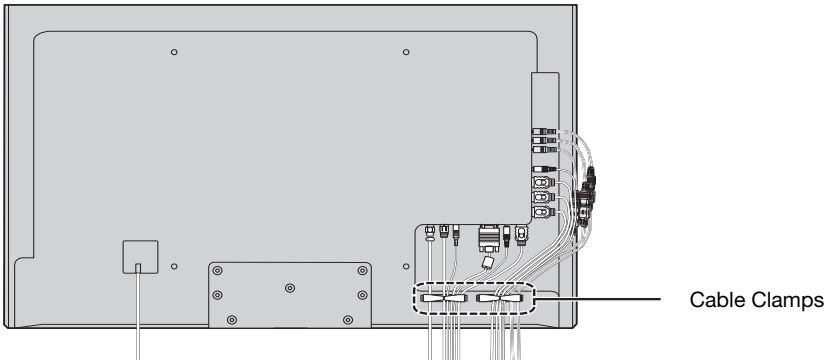

# Chapter 2: Connecting your TV

## Overview of cable types

Before purchasing cables, know the connector types your devices require.

You can purchase cables from most stores that sell audio/video devices.

### Coaxial cable (F-type)



(F-type) Connects your antenna, cable TV service, or cable converter box to your TV.

### Standard A/V cables (composite video)

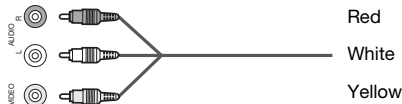

Use with video devices with analog audio and composite video output. These cables (and the related inputs on your TV) are often color-coded.

### Component video cables

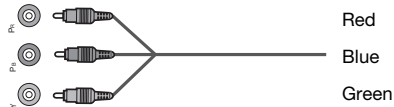

Use with video devices with component video output. Separate audio cables are required. (ColorStream® is a Toshiba brand.)

**Note:** Component video cables provide better picture quality than composite video cables.

### HDMI® cable (HDMI)



Use with devices with an HDMI output. An HDMI cable delivers digital audio and video in its native format. Separate audio cables are not required (see p. 16, 19–20).

**Note:** HDMI cables provide the best audio and picture quality.

### Optical audio cable



Connects receivers with Dolby Digital or PCM (pulse-code modulation) optical audio input to the TV's **DIGITAL AUDIO OUT** terminal (see p. 18).

### Analog RGB (15-pin) computer cable

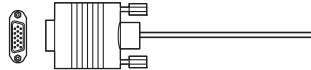

Connects a PC to the TV's **PC IN** terminal (see p. 20).

**Note:** Separate audio cables are required.

### Standard/Crossover LAN cable



Standard LAN cable is used to connect the TV to your home network (see p. 21).

Crossover LAN cable is used to connect the TV directly to a PC (see p. 21).

## About the illustrations

**Note:** The connection illustrations shown are representative of typical device connections only. The input/output terminals on your devices may differ. See each device's owner's manual.

## Connecting to a Satellite dish, an Antenna, or Cable TV

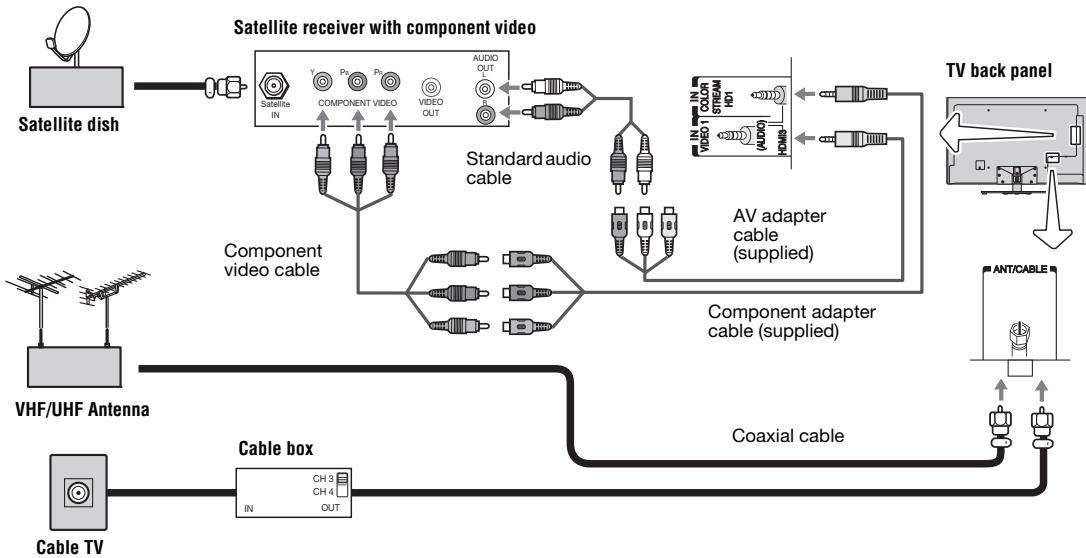

**You will need:**

- Coaxial cables
- AV adapter cable (supplied)
- Standard audio cable
- Component adapter cable (supplied)
- Component video cable

**To view satellite programs using the component video connections:**

Turn on the satellite receiver. Press **INPUT** and **▲** or **▼** to select **ColorStream HD1**. Use the satellite receiver's controls to change channels.

**To view the antenna or cable signal:**

Press **INPUT** and **▲** or **▼** to select **ANT/CABLE**.

**To view basic and premium cable channels:**

Turn on the cable box. Press **INPUT** and **▲** or **▼** to select **ANT/CABLE**. Tune the TV to channel 3 or 4 (the channel the cable box output is set to). Use the cable box's controls to change channels.

The unauthorized recording, use, distribution, or revision of television programs, videotapes, DVDs, and other materials are prohibited under the Copyright Laws of the United States and other countries, and may subject you to civil and criminal liability.

## Connecting an HDMI® or DVI device to the HDMI input

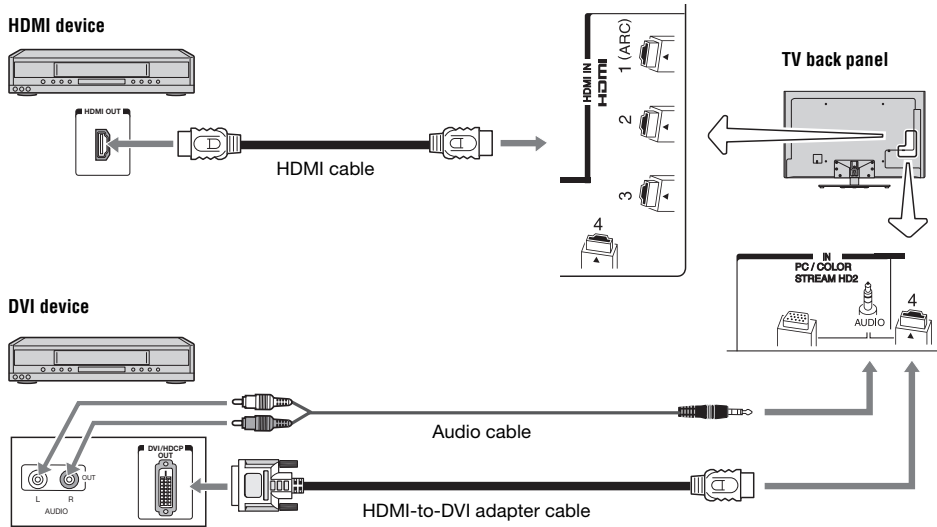

The HDMI input on your TV receives digital audio and uncompressed digital video from an HDMI device, or uncompressed digital video from a DVI (Digital Visual Interface) device.

This input is designed to accept HDCP (High-Bandwidth Digital-Content Protection) program material in digital form from EIA/CEA-861-D compliant[1] consumer electronic devices (such as a set-top box or DVD player with HDMI or DVI output). Supported signal formats: VGA, SVGA, XGA, WXGA, SXGA, 480i (60Hz), 480p (60Hz), 720p (60Hz), 1080i (60Hz), and 1080p (24Hz/60Hz). For signal specifications, see p. 76.

Supported Audio format: Linear PCM, sampling rate 32/44.1/48 kHz.

### Note:

- For connecting a PC to the HDMI input, see p. 20.
- Some legacy HDMI sources may not work properly with your HDMI TV due to the adoption of new standards. Try disabling the options in **HDMI Settings**. (p. 41).

### To connect an HDMI device, you will need:

- One HDMI cable per HDMI device
  - Recommendation: For proper operation, use an HDMI cable with the HDMI Logo (**HDMI**).
  - To display an 1080p/60 Hz signal format, you need a High Speed HDMI cable. A conventional HDMI/DVI cable may not work properly.
  - An HDMI cable transfers video and audio. Separate analog audio cables are not required.

### To view the HDMI device video:

Press **INPUT** and **▲** or **▼** to select **HDMI 1**, **HDMI 2**, **HDMI 3**, or **HDMI 4**.

**Note:** For programming the TV remote control to operate other devices, see p. 79.

### To connect a DVI device, you will need:

- HDMI-to-DVI adapter cable
  - For proper operation, the length of the HDMI-to-DVI adapter cable must not exceed 9.8 ft (3m). Recommended length: 6.6 ft (2m).
- 3.5mm Stereo to RCA Y-Cable
  - An HDMI-to-DVI adapter cable transfers video only. Separate analog audio cables are required.

**Note:** To ensure that the HDMI or DVI device is reset properly:

- When turning on electronic components, **turn on the TV first** and then the HDMI or DVI device.
- When turning off electronic components, **turn off the HDMI or DVI device first** and then the TV.

[1] EIA/CEA-861-D compliance covers the transmission of uncompressed digital video with high-bandwidth digital content protection, which is being standardized for reception of high-definition video signals. Because this is an evolving technology, it is possible that some devices may not operate properly with the TV.



## Connecting a VCR or DVD player with ColorStream® (component video)

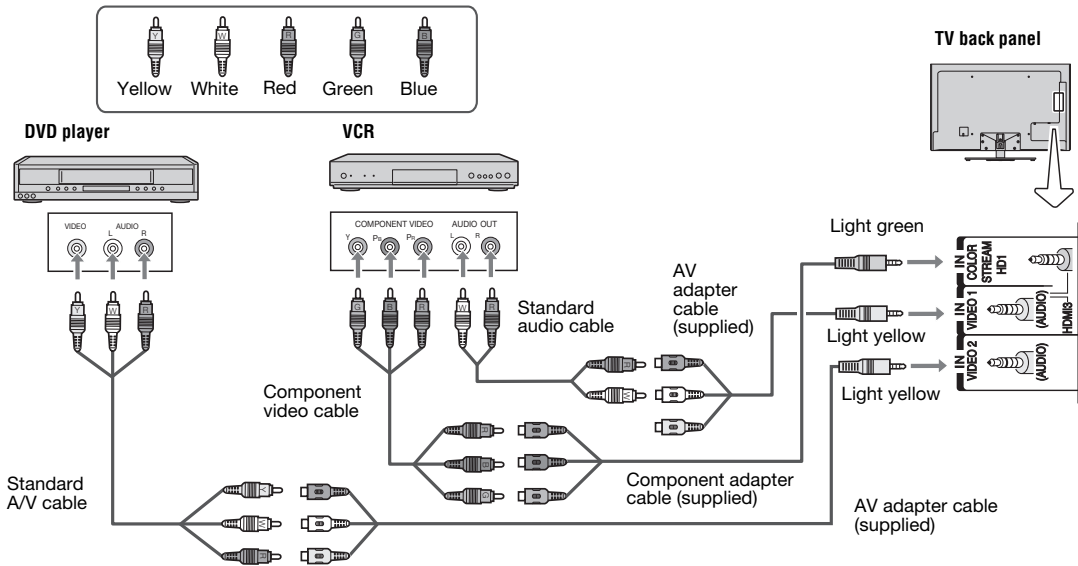

### You will need:

- Standard A/V cable
- AV adapter cable (supplied)
- Standard audio cable
- Component adapter cable (supplied)
- Component video cable
  - You can connect the component video cables from the DVD player to the **ColorStream HD1** terminal on the TV. Separate audio cables are required. You can use the **ColorStream HD1** terminal to display Progressive (480p, 720p, 1080p) and Interlaced (480i, 1080i) video. Check the owner's manual of the DVD player in order to determine the best output signal available (1080p 24 Hz/30 Hz/50 Hz/25 Hz are not supported).
  - If your DVD player does not have component video, connect a composite video cable to **VIDEO 2** on the side panel. If your DVD player has HDMI video, see p. 16.

### To view the DVD player:

Turn on the DVD player. Press **[INPUT]** and **▲** or **▼** to select **ColorStream HD1**. Audio configuration is required. See "Side Shared Audio" (p. 30), and select **ColorStream HD1**.

**To view the VCR or view and antenna-sourced:** Turn on the VCR. Tune the VCR to the channel you want to watch. Press **[INPUT]** and **▲** or **▼** to select **Video 2**.

**Note:** For programming the TV remote control to operate other devices, see p. 79.

**The unauthorized recording, use, distribution, or revision of television programs, videotapes, DVDs, and other materials are prohibited under the Copyright Laws of the United States and other countries, and may subject you to civil and criminal liability.**

## Connecting a digital audio system

The TV's **DIGITAL AUDIO OUT** terminal outputs a Dolby® Digital or 2-channel down-mixed PCM (pulse-code modulation) signal for use with an external Dolby Digital decoder or other external audio systems with digital audio input.

**You will need:**

- Optical audio cable (Use an optical audio cable that has the larger TosLink connector, not the smaller mini-optical connector.)

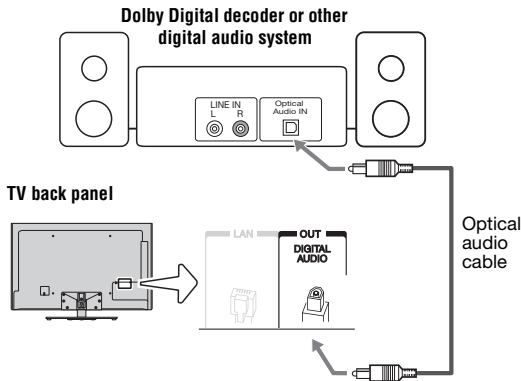

**Before controlling the audio:**

- See "Selecting the optical audio output format" (p. 53).

**Note:**

- Some audio systems may not be compatible with Dolby Digital bitstream signals. Older audio systems that are not compatible with standard optical out signals may not work properly, creating a high noise level that may damage speakers or headphones. **THIS DAMAGE IS NOT COVERED BY YOUR WARRANTY.**
- The DIGITAL AUDIO OUT terminal may not output some digital audio sources due to copy restrictions.
- The Dolby Digital format is available in the following situations:
  - When tuned to a digital RF channel.
  - When an HDMI input is used.
  - When DLNA Certified products or widgets are used.

Manufactured under license from Dolby Laboratories. Dolby and the double-D symbol are registered trademarks of Dolby Laboratories.

## Using the TV remote and HDMI® CEC Control to control other devices

To control the basic functions of connected audio/video devices using the TV's remote control, connect an HDMI® CEC compatible audio receiver or playback device. The HDMI® CEC Control feature uses CEC technology as regulated by the HDMI standard.

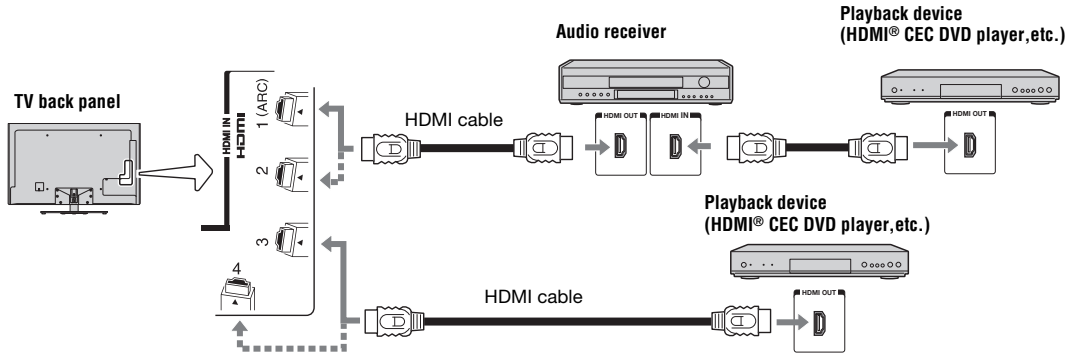

To connect an audio receiver and playback devices, you will need:

- HDMI cables (see p. 14)

**Note:**

- If several devices are connected, the HDMI® CEC Control feature may not operate properly.
- For proper operation, it is recommended that you use HDMI cables with the HDMI Logo (HDMI).

**Before controlling the devices:**

- For an explanation of setup and operations, see “Using HDMI® CEC Control” (see p. 39).
- Configure the connected devices. See each device's operation manual.

**Note:** This feature is limited to models incorporating Toshiba's HDMI® CEC Control feature. However, Toshiba is not liable for those operations. See the individual instruction manuals for compatibility information.

**When using an external AV amplifier:**

The picture and sound may not be properly synchronized. In this case, adjust the delay time of the sound on the AV amplifier.

**Note:** The control range of the delay time differs according to the device you use.

## Connecting an HDMI audio system

If your HDMI amplifier supports ARC, audio from the TV can be sent to the amplifier via the existing HDMI cable.

**You will need:**

- HDMI cable

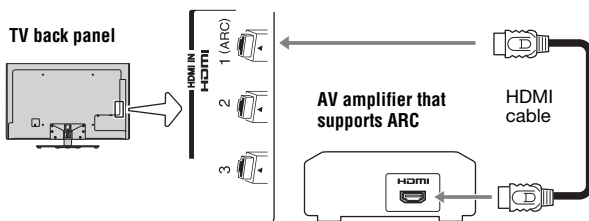

**HDMI's ARC (Audio Return Channel) feature**

This feature enables the audio signal of the TV to be sent to an AV amplifier via the HDMI cable. It will not be necessary to connect a cable from the audio output of the TV to the audio input of the AV amplifier to reproduce the audio received from the tuner of the TV through the AV amplifier.

**Note:** Only HDMI 1 supports ARC.

### Connecting a PC

You can view your PC's display on the TV and hear the sound from the TV's speakers.

#### Connecting to the TV's PC IN terminal

**You will need:**

- Analog RGB (15-pin) computer cable
- PC audio cable

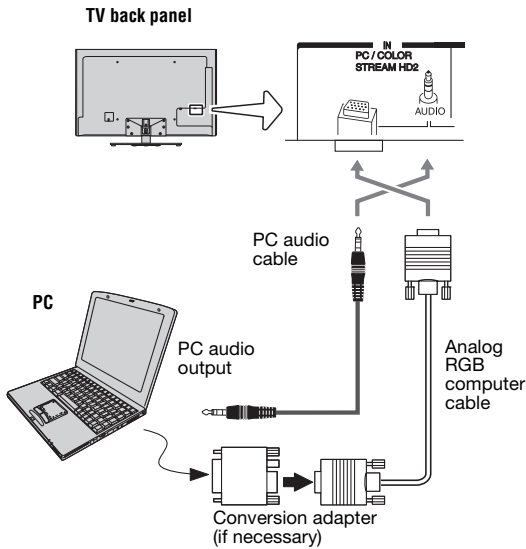

#### Before using the PC:

See "Using your PC with the TV" (p. 42).

#### To use a PC:

- Set the monitor output resolution on the PC before connecting it to the TV.
- Supported signal formats: VGA, SVGA, XGA, WXGA, and SXGA. For signal specifications, see p. 75.

#### Note:

- The PC audio input terminal on the TV is shared with the HDMI 4 and ColorStream HD2 terminal. For configuration, see "Setting the PC audio" (p. 42).
- Some PC models cannot be connected to this TV.
- If the PC has a compatible mini D-sub 15-pin terminal, an adapter is not required.
- Depending on the DVD's title and the PC's specifications, some scenes may be skipped or you may not be able to pause during multi-angle scenes.

#### Signal names for mini D-sub 15-pin connector

| Pin No. | Signal name | Pin No. | Signal name | Pin No. | Signal name |
|---------|-------------|---------|-------------|---------|-------------|
| 1       | R           | 6       | Ground      | 11      | NC          |
| 2       | G           | 7       | Ground      | 12      | NC          |
| 3       | B           | 8       | Ground      | 13      | H-sync      |
| 4       | NC *        | 9       | NC          | 14      | V-sync      |
| 5       | NC          | 10      | Ground      | 15      | NC          |

\* NC=Not connected

#### Connection to the TV's HDMI terminal

**You will need:**

If your PC has no HDMI terminal:

- Adapter cable
- Analog audio cable

If your PC has an HDMI or DVI terminal:

- HDMI cable or HDMI-to-DVI adapter cable

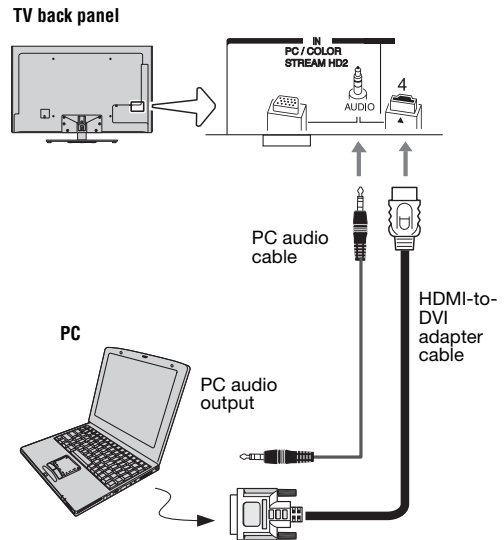

Supported signal formats: VGA, SVGA, XGA, WXGA, SXGA, 480i (60Hz), 480p (60Hz), 720p (60Hz), 1080i (60Hz), and 1080p (24Hz/60Hz). For signal specifications, see p. 76.

#### Note:

- The edges of the picture may be hidden.
- The PC audio input terminal on the TV is shared with the HDMI 4 and ColorStream HD2 terminal. For configuration, see "Setting the PC audio" (p. 42).

## Connecting to a home network

The LAN port allows your Toshiba TV to connect to your home network. You can use this home network to access photos, movies, and music files that are stored on a DLNA CERTIFIED™ Server and play them on your TV.

### Connecting the TV directly to a PC without an Internet connection

You will need:

- Crossover LAN cable

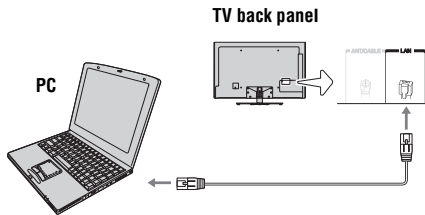

### Connecting the TV to a home network without an Internet connection

You will need:

- Standard LAN cables
- Router with Hub

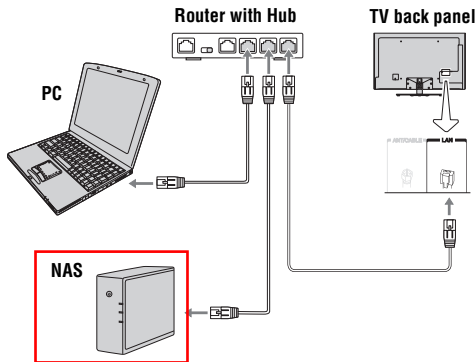

### Connecting the TV to a home network with an Internet connection - Wired

You will need:

- Coaxial or telephone cable (depending on your modem type)
- Standard LAN cables
- Router with Hub
- Modem (DSL or cable)

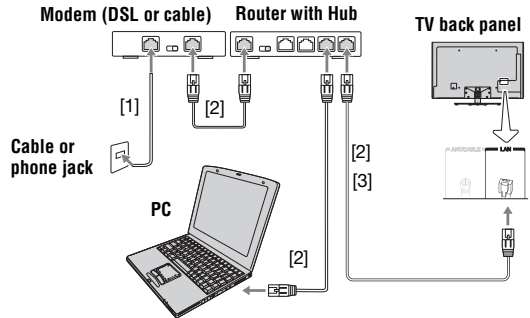

[1] Coaxial or telephone cable (depending on your modem type)

[2] Standard LAN cable

[3] Do NOT connect a phone jack directly to the TV's LAN port.

### Connecting the TV to a home network with an Internet connection - Wireless

You will need:

- Coaxial or telephone cable (depending on your modem type)
- Standard LAN cables
- Wireless LAN access point
- Modem (DSL or cable)

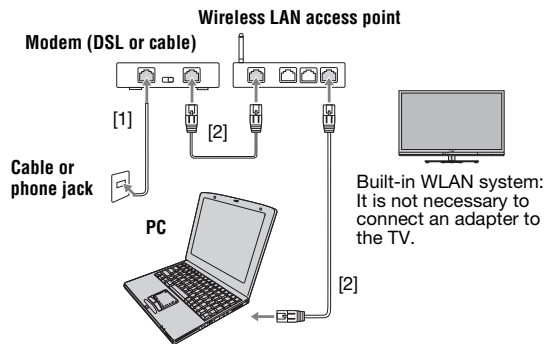

The transmission speed over the wireless LAN and the distance over which wireless LAN can reach may vary depending on surrounding electromagnetic environment, obstacles, access point design and configuration, and client design and software/hardware configurations. The actual transmission speed will be lower than the theoretical maximum speed.

[1] Coaxial or telephone cable (depending on your modem type)

[2] Standard LAN cable

# Chapter 3: Using the remote control

## Controlling other devices

The TV's remote control can operate other devices such as cable converter boxes, satellite receivers, VCRs, DVD players, and HTIBs (home theater in a box).

### Toshiba devices:

The remote is programmed to operate a variety of devices (see p. 79).

### Non-Toshiba devices or Toshiba devices that the remote control is not programmed to operate:

Program the remote (see p. 79).

## Installing batteries

- 1 Pull up to open the cover.

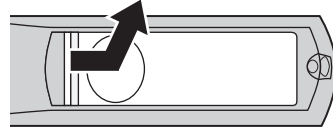

- 2 Install two AA size batteries.

**Note:** Use carbon zinc batteries or alkaline batteries.

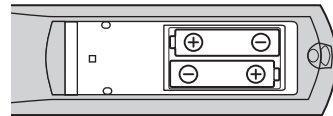

- 3 Slide on the cover.

**Caution:** Do not expose batteries to excessive heat such as sunshine, fire, or the like.

### Note:

- Every time you change the batteries, you must reprogram the remote.
- Dispose of batteries in a designated disposal area.
- Always consider the environment when disposing of batteries. Always follow applicable laws and regulations.
- If the remote does not operate correctly, or if the operating range is reduced, replace the batteries.
- Always replace both batteries with new ones. Never mix battery types or use new and used batteries together.
- Always remove batteries from the remote if they are dead or if the remote control is not to be used for an extended period of time. This prevents battery acid from leaking into the battery compartment.



## Learning about the Remote Control

The buttons described in this section operate the TV only.

For the HDMI® CEC Control functions, see “Using HDMI® CEC Control” (p. 39).

For a complete list of the remote’s functions, see “Remote control functional key chart” (p. 77–78).

Changes the picture mode to **Game** when the input mode is ColorStream HD, PC, Video, or HDMI® (p. 48).

Sets the remote control mode to control the device: **TV**, **CABLE/SAT**, **BD/DVD**, or **AUX**. To control the TV, press **TV**.

When the Auto Input feature is set, you can use these keys to change inputs on the TV (p. 31).

Accesses the Quick menu.

Reduces or turns off the sound (p. 52).

Adjusts the volume level.

Displays the NET TV™ menu (p. 60).

Accesses Netflix (p. 61).

Accesses the main TV menu system (p. 25, 26).

Displays Channel Browser™ (p. 32). / Scrolls to left.

Returns to the previous menu.

Moves to the previous/next page.

Accesses the sleep timer (p. 43)

Selects the picture size (p. 45).

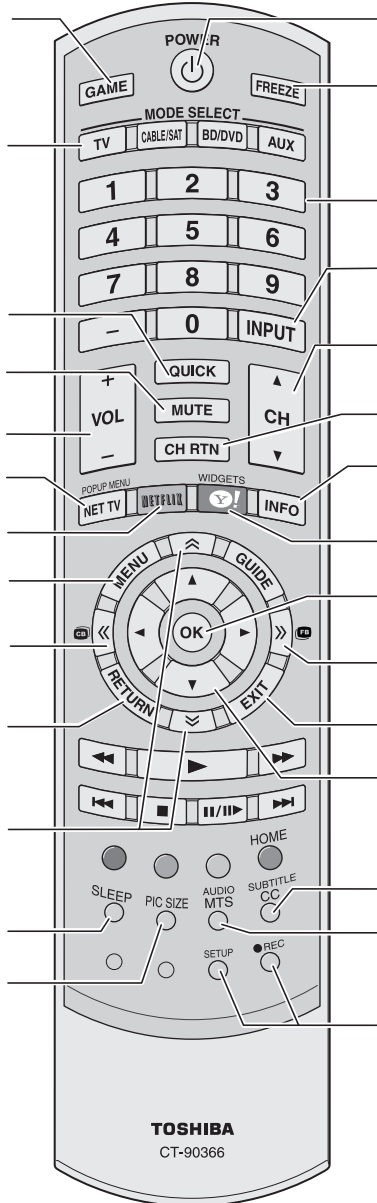

Turns the TV on and off.

Freezes the picture (p. 47).

Directly tune channels. The “-” button is used to enter 2-part channel numbers (p. 32) or edit the Favorites List (p. 33).

Selects the video input source (p. 34).

Cycles through programmed channels.

Returns to the last viewed channel or source (p. 34).

Displays TV status information as well as program details, when available (p. 44).

Displays/hides the Yahoo!® TV Widgets user interface (p. 62).

Activates highlighted items in the main menu system.

Displays Favorite Browser (p. 33). / Scrolls to right.

Closes onscreen menus.

When a menu is onscreen, these buttons select or adjust programming menus.

Opens the closed caption selector (p. 35).

Selects the audio mode.

These buttons are used for BD/DVD, CABLE/SAT, and VCR mode.

**Note:** The error message “NOT AVAILABLE” may appear if you press a key for a function that is not available.

# Chapter 4: Initial Setup and Menu

## Initial Setup

When you first turn on or reset the TV, the Initial Setup window will appear.

### Note:

- You can stop Initial Setup by pressing **EXIT**. However, if you do not finish Initial Setup, the Initial Setup screen will appear every time you turn on your TV. To finish Initial Setup, see “Changing Initial settings” (p. 28).
- **EXIT** does not work until **Menu Language**, **Time Zone**, and **Location** have been set.

### 1 Menu Language



Select a language.

### 2 Time Zone



Select a time zone.

### 3 Daylight Saving Time



Select **On** or **Off**. Press **OK**.

### 4 Location

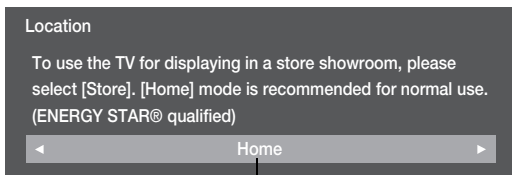

Select **Home** for normal home use. Press **OK**.

### 5 ANT/CABLE

To select **Antenna**:

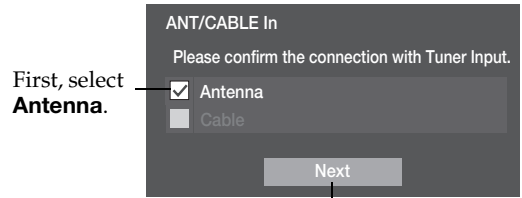

Then, select **Next**. Press **OK**.

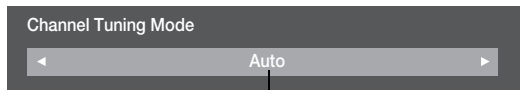

Select **Auto**, **Digital**, or **Standard** (see “Setting the Channel Tuning Mode” on p. 32). Press **OK**.

To select **Cable**:

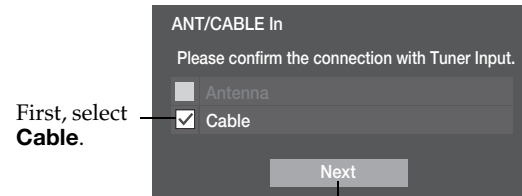

Then, select **Next**. Press **OK**.

**Note:** If you do not want to scan channels, you do not need to make a selection for **ANT/CABLE**. Select **Next** and press **OK** to skip this step.

### 6 Start Scan



Press **OK**.

**Note:** If you want to stop scanning, press **EXIT** while scanning.

- After scanning is complete, a channel list screen (such as the one below) will appear. Press **OK** or **EXIT**.

| Auto Tuning (Antenna)      |  |      |        |
|----------------------------|--|------|--------|
| Antenna Channels Found: 14 |  |      |        |
| Ch.                        |  | Type | RF Ch. |
| 2                          |  | ATV  | 2      |
| 4-1                        |  | DVI  | 4      |
| 4-2                        |  | DVI  | 4      |
| 6                          |  | ATV  | 6      |
| 11                         |  | ATV  | 11     |
| 13                         |  | ATV  | 13     |
| 18                         |  | ATV  | 18     |
| 31                         |  | ATV  | 31     |

**If some channels are not found after scanning:**

- Check the antenna/cable connections, and scan again.
- Connect the TV to the antenna or cable box directly and scan again.

- 1 **MENU** > **Settings** > **SETUP** > **Quick Setup** > **OK**.
- 2 A confirmation message appears. Press **◀** or **▶** to select **Yes**. Press **OK**.
- 3 Repeat set up to Step 6.
  - If you selected **Antenna** previously, select **Cable**.
  - If you selected **Cable** previously, select **Antenna**.
- 4 Scan again.

### 7 Support Information

The Support Information screen appears. Press **OK**.

**Note:** Refer to this information if there is any problem. This can be confirmed from the following operation at any time.

- 1 **MENU** > **Settings** > **SETUP** > **System Information** > **OK**.

## Navigating the menu system

- To open the main menu, press **MENU** on the remote control or TV control panel.



- Press **▲**, **▼**, **◀**, or **▶** on the remote control or TV control panel to navigate and make selections.
- To select a menu option, press **OK**.
- To move to the next menu page, press **OK** or **▲**.
- To return to the previous menu page, press **RETURN** or **▼**.
- To close a menu instantly, press **MENU** or **EXIT**.
- All menus will close automatically if you do not make a selection within 60 seconds.

### Main menu layout

To open the main menus (illustrated below), press  on the remote control or TV control panel.

| 1st Layer    | 2nd Layer            | 3rd Layer                                 | Page |
|--------------|----------------------|---|------|
| Network      | NET TV               |   | 60   |
|              | Network Setup        |   | 56   |
|              | Wireless Information |   | 57   |
| Media Player | Photo                | (Device select)                           | 67   |
|              | Movie                | (Device select)                           | 65   |
|              | Music                | (Device select)                           | 66   |
| Wallpaper    |                      |   | 69   |
| Timer        | On Timer             |   | 42   |
|              | Sleep Timer          |   | 43   |
|              | Game Timer           |   | 39   |
| Settings     | PICTURE              | Picture Mode                              | 48   |
|              |                      | Reset                                     | 48   |
|              |                      | Backlight                                 | 48   |
|              |                      | Contrast                                  | 48   |
|              |                      | Brightness                                | 48   |
|              |                      | Color                                     | 48   |
|              |                      | Tint                                      | 48   |
|              |                      | Sharpness                                 | 48   |
|              |                      | Advanced Picture Settings                 | 49   |
|              |                      | Expert Picture Settings                   | 51   |
|              | TheaterLock          | 52  |      |
|              | SOUND                | MTS                                       | 52   |
|              |                      | Balance                                   | 53   |
|              |                      | Bass                                      | 53   |
|              |                      | Treble                                    | 53   |
|              |                      | Advanced Sound Settings                   | 54   |
|              |                      | Dynamic Volume (Audyssey Dynamic Volume®) | 53   |
|              |                      | Dynamic Range Control                     | 53   |

| 1st Layer                  | 2nd Layer      | 3rd Layer         | Page |                        |    |
|----------------------------|----------------|-------------------|------|------------------------|----|
| Settings                   | APPLICATIONS   | Widgets           | 62   |                        |    |
|                            |                | NET TV            | 60   |                        |    |
|                            |                | Media Player      | 64   |                        |    |
|                            |                | Channel Browser   | 32   |                        |    |
|                            |                | Favorites Browser | 33   |                        |    |
|                            |                | On Timer          | 42   |                        |    |
|                            |                | Sleep Timer       | 43   |                        |    |
|                            |                | PREFERENCES       |      | HDMI-CEC Control Setup | 39 |
|                            |                |                   |      | Network Setup          | 56 |
|                            |                |                   |      | Netflix Setup          | 61 |
| VUDU Deactivation          | 61             |                   |      |                        |    |
| Wallpaper Setup            | 69             |                   |      |                        |    |
| Channel Browser Setup      | 32             |                   |      |                        |    |
| PIN Setting                | 36             |                   |      |                        |    |
| Parental Control and Locks | 36             |                   |      |                        |    |
| Display Settings           | 42, 47         |                   |      |                        |    |
| AV Connection              | 29, 30, 41, 53 |                   |      |                        |    |
| Auto Input                 | 31             |                   |      |                        |    |
| Energy Saving Settings     | 43             |                   |      |                        |    |
| HDMI Information           | 41             |                   |      |                        |    |
| Display                    |                |                   |      |                        |    |



| 1st Layer | 2nd Layer | 3rd Layer          | Page              |
|-----------|-----------|--------------------|-------------------|
| Settings  | SETUP     | Menu               | 28                |
|           |           | Language           |                   |
|           |           | ANT/CABLE In       | 28                |
|           |           | Auto Tuning        | 28                |
|           |           | Manual Tuning      | 29                |
|           |           |                    | 28,<br>29,<br>29, |
|           |           | TV Settings        | 32,<br>35,<br>38  |
|           |           | Quick Setup        | 28                |
|           |           | Location           | 28                |
|           |           | Software Upgrade   | 60                |
|           |           | Software Licenses  | 60                |
|           |           | System Information | 44                |
|           |           | Reset TV           | 44                |

## Quick menu

Quick menu helps you access some options more quickly.

Press **[QUICK]** to display the Quick menu and press **▲** or **▼** to select an option.

**Note:** Quick menu items differ depending on the current mode.

| Quick menu Item         | Page       |
|-------------------------|------------|
| PICTURE                 | 45–52      |
| Picture Mode            | 48         |
| Picture Size            | 45         |
| Repeat                  | 66, 67, 68 |
| SOUND                   | 52–54      |
| Background Music        | 68         |
| Speakers                | 41         |
| HDMI-CEC Player Control | 40         |
| Interval Time           | 68         |

# Chapter 5: Setting up your TV

How to navigate the menu:

**MENU** > Settings > Main menu > Submenu > **OK**

| Format      | Description  |
|-------------|--|
| <b>MENU</b> | Press the <b>MENU</b> button.  |
| Settings    | Press <b>◀</b> or <b>▶</b> to select <b>Settings</b> .   |
| > Main menu | Press <b>◀</b> or <b>▶</b> to select a menu icon ( <b>PICTURE, SOUND, APPLICATIONS, PREFERENCES, SETUP</b> ) |
| > Submenu   | Press <b>▲</b> or <b>▼</b> to select a menu.   |
| > <b>OK</b> | Press the <b>OK</b> button   |

## Changing Initial settings

From Quick Setup:

- MENU** > **Settings** > **SETUP** > **Quick Setup** > **OK**.
- A confirmation message appears. Press **◀** or **▶** to select **Yes**. Press **OK**.
- For changing settings, see “Initial Setup” (p. 24).

From individual settings:

## Menu language

You can choose from three different language settings (**English, Français, and Español**) for menus and messages

- MENU** > **Settings** > **SETUP** > **Menu Language**.
- Press **◀** or **▶** to select your preferred language. Press **EXIT**.

## Local Time Setting

This setting allows you to specify the correct time zone for your region.

- MENU** > **Settings** > **SETUP** > **TV Settings** > **OK**.
- Press **▲** or **▼** to select **Local Time Setting**. Press **OK**.
- Select an option:
  - Time Zone**
  - Daylight Saving Time**
- Press **◀** or **▶** to select your time zone or to select **On** to activate **Daylight Saving Time**. Press **EXIT**.

## Location

You can select Home or Store for the TV location. For normal home use, select Home.

- MENU** > **Settings** > **SETUP** > **Location**.
- Press **◀** or **▶** to select **Home**. Press **EXIT**.

## ANT/CABLE IN

This setting configures the antenna input source for the ANT/CABLE terminal.

- MENU** > **Settings** > **SETUP** > **ANT/CABLE In**.
- Press **◀** or **▶** to select the input source (**Antenna** or **Cable**) for the **ANT/CABLE** input. Press **EXIT**.

## Storing channels in memory (optional)

To make sure your TV stops only on the channels you want when you press **CH** or **CH** on the remote control or the control panel, store those channels in the TV's memory.

## Auto Tuning

**Note:** You must set up the antenna/cable input source first. See “Initial Setup” (p. 24).

You can set up the TV to detect all active channels in your area and store them in its memory. Then you can manually store or skip individual channels from memory.

| Option  | Description  |
|---------|--|
| Cable   | <b>Note:</b> If you select Cable, auto tuning deletes previously stored channels from memory.<br>This setup requires some time, but you do not need to repeat the setup unless your cable TV service's lineup changes significantly. |
| Antenna | Auto tuning retains stored channels and stores newly found channels into memory.<br>To skip an antenna source channel from memory, set the channel to be skipped. See “Skipping channels”.   |

**Note:** To tune channels not stored in memory, use buttons 0–9 and **□** on the remote control.



- 1 **MENU** > **Settings** > **SETUP** > **Auto Tuning** > **OK**.  
A confirmation screen appears.
- 2 Press **OK** to start Auto Tuning or **EXIT** to abort.  
The TV cycles through all the channels and stores all active channels in memory.  
To view the programmed channels, press **▲** **CH** or **CH** **▼**.

## Manual Tuning

After storing channels in memory, you can manually enter channels if the channel number is known.

- 1 **MENU** > **Settings** > **SETUP** > **Manual Tuning** > **OK**.
- 2 Use buttons 0–9 on the remote control to enter the channel number (for example, 56). Press **OK**.
- 3 Press **OK** to start Manual Tuning.

The channels found are listed at the center of the screen.

| Type | Description     |
|------|-----------------|
| ATV  | Analog channel  |
| DTV  | Digital channel |

## Skipping channels

To prevent a channel from being viewed, you can set it to be skipped.

- 1 **MENU** > **Settings** > **SETUP** > **TV Settings** > **OK**.
- 2 Press **▲** or **▼** to select **Channel Options**. Press **OK**.  
The list of channels appears.

| Ch. | Type | Label | ⏏                        | 🔒                        |
|-----|------|-------|--------------------------|--------------------------|
| 5-1 | DTV  |       | <input type="checkbox"/> | <input type="checkbox"/> |
| 6   | ATV  |       | <input type="checkbox"/> | <input type="checkbox"/> |
| 6-1 | DTV  |       | <input type="checkbox"/> | <input type="checkbox"/> |
| 8   | ATV  |       | <input type="checkbox"/> | <input type="checkbox"/> |
| 9   | ATV  |       | <input type="checkbox"/> | <input type="checkbox"/> |
| 10  | ATV  |       | <input type="checkbox"/> | <input type="checkbox"/> |
| 11  | ATV  |       | <input type="checkbox"/> | <input type="checkbox"/> |
| 12  | ATV  |       | <input type="checkbox"/> | <input type="checkbox"/> |

- 3 Move to the **⏏** column. Press **▲** or **▼** to select a channel to skip. Press **OK**. The box is selected. To clear the selection, press **OK**.

**Note:** You cannot tune skipped channels using **▲** **CH** or **CH** **▼**. Use buttons 0–9 and **□** on the remote control.

## Skipping video inputs

You can set video inputs to be skipped when selecting inputs in the Input selection window.

To turn on skip:

- 1 **MENU** > **Settings** > **PREFERENCES** > **AV Connection** > **OK**.
- 2 Press **▲** or **▼** to select **Input Labeling**. Press **OK**.
- 3 Press **▲** or **▼** to select the item you want to be skipped. Press the **RED** button to turn on **Skip**.

To turn off skip:

Press again the **RED** button to turn off **Skip**.

## Labeling channels

You can label analog TV channels.

- 1 **MENU** > **Settings** > **SETUP** > **TV Settings** > **OK**.
- 2 Press **▲** or **▼** to select **Channel Options**. Press **OK**. The list of channels appears.

| Channel Options |       |       |                          |                          |
|-----------------|-------|-------|--------------------------|--------------------------|
| Ch.             | Type  | Label | 🔊                        | 🔒                        |
| 5-1             | [DTV] |       | <input type="checkbox"/> | <input type="checkbox"/> |
| 6               | [ATV] |       | <input type="checkbox"/> | <input type="checkbox"/> |
| 6-1             | [DTV] |       | <input type="checkbox"/> | <input type="checkbox"/> |
| 8               | [ATV] |       | <input type="checkbox"/> | <input type="checkbox"/> |
| 9               | [ATV] |       | <input type="checkbox"/> | <input type="checkbox"/> |
| 10              | [ATV] |       | <input type="checkbox"/> | <input type="checkbox"/> |
| 11              | [ATV] |       | <input type="checkbox"/> | <input type="checkbox"/> |
| 12              | [ATV] |       | <input type="checkbox"/> | <input type="checkbox"/> |

- 3 Press **▲** or **▼** to select a channel to label.
- 4 Press **OK**. The Software Keyboard window appears.
- 5 Input a name using the Software Keyboard (see p. 59).
- 6 Press the **BLUE** button.

**Note:** Input the desired analog channel label up to 7 characters.

## Labeling video inputs

The input labels are shown in the input selector, and in the Channel Browser and banner displays. You can label video inputs according to the devices you have connected to the TV.

- 1 **MENU** > **Settings** > **PREFERENCES** > **AV Connection** > **OK**.
- 2 Press **▲** or **▼** to select **Input Labeling**. Press **OK**.
- 3 Press **▲** or **▼** to select the item you want to label. Press **◀** or **▶** to select **--**, **Amplifier**, **Cable**, **DVD**, **Game**, **PC**, **Recorder**, **Satellite**, or **VCR** or press the **GREEN** button to select **User Input**.

**Note:** When **User Input** is selected by pressing the **GREEN** button, the Software Keyboard window will appear. Input the desired characters (up to 10 characters) using the Software Keyboard (see p. 59) or the number buttons for a number input. To save your settings, press the **BLUE** button.

- 4 Repeat Step 3 for other video inputs.

## Configuring shared inputs

### Side Shared Audio

- 1 **MENU** > **Settings** > **PREFERENCES** > **AV Connection** > **OK**.
- 2 Press **▲** or **▼** to select **Side Shared Audio**.
- 3 Press **◀** or **▶** to select **ColorStream HD1**, **Video 1**, or **HDMI 3**.

### Rear Shared Audio

- 1 **MENU** > **Settings** > **PREFERENCES** > **AV Connection** > **OK**.
- 2 Press **▲** or **▼** to select **Rear Shared Audio**.
- 3 Press **◀** or **▶** to select **PC (ColorStream HD2)** or **HDMI 4**.

### Shared PC Input

- 1 **MENU** > **Settings** > **PREFERENCES** > **AV Connection** > **OK**.
- 2 Press **▲** or **▼** to select **Shared PC Input**.
- 3 Press **◀** or **▶** to select **PC** or **ColorStream HD2**.

## Setting the Auto Input feature



You can change TV inputs using the **MODE SELECT** buttons on the remote control: **TV, CABLE/SAT, BD/DVD, AUX**. After setting an input for a specific **MODE SELECT** button, the TV automatically switches to the input when you press and hold the **MODE SELECT** button for 2 seconds and release it.

Auto Input settings options for each **MODE SELECT** button:

| Mode      | Inputs   |
|-----------|--|
| TV        | ANT/CABLE  |
| CABLE/SAT | ANT/CABLE, Video 1, Video 2, ColorStream HD1, HDMI 1, HDMI 2, HDMI 3, HDMI 4, PC (ColorStream HD2) |
| BD/DVD    | Video 1, Video 2, ColorStream HD1, HDMI 1, HDMI 2, HDMI 3, HDMI 4, PC (ColorStream HD2)            |
| AUX       | ANT/CABLE, Video 1, Video 2, ColorStream HD1, HDMI 1, HDMI 2, HDMI 3, HDMI 4, PC (ColorStream HD2) |

**Note:** The TV mode select button will be restricted to the ANT/CABLE input.

### To set Auto Input:

- 1  > **Settings** > **PREFERENCES** > **Auto Input** > .
- 2 Set **Enable Auto Input** to **On**.
- 3 Press **▲** or **▼** to select the mode you want to set.
- 4 Press **◀** or **▶** to select an input source for that mode.
- 5 Repeat the procedure for other modes.

### To turn off Auto Input:

Select **Off** in Step 2.

### To reset Auto Input:

Select **Reset**. Press .

# Chapter 6: Basic features

## Tuning channels

### Setting the Channel Tuning Mode

You can select how tuning is handled for analog and digital channels when the TV is in Antenna mode.

**Note:** To use this feature, **ANT/CABLE In** must be set to **Antenna** (p. 28).

- 1 > **Settings** > **SETUP** > **TV Settings** > .
- 2 Press or to highlight **Channel Tuning Mode**.

| Mode           | Description  |
|----------------|--|
| Standard       | You can tune both analog and digital channels normally.  |
| Auto (default) | Digital channels have priority when manually entering a channel number using the 0-9 buttons on the remote. To tune analog channels, use     /     if available. |
| Digital        | You can only tune digital channels.  |

- 3 Press or to select a mode. Press .

**Note:** The Channel Options screen and the Channel Browser ANT/CABLE List are updated when you change the mode. The History List is cleared, but the Favorites List is saved.

### Tuning in to the next programmed channel

Press | or | on the remote control or TV control panel.

**Note:** This feature does not work unless you store channels in the TV's channel memory (p. 28).

### Tuning in to a specific channel (programmed or unprogrammed)

| Channel | Description   |
|---------|---|
| Analog  | Use the 0-9 buttons on the remote control. (For example, to select channel 125, press 1, 2, 5.) Press .   |
| Digital | Use the 0-9 buttons on the remote control to enter the major channel number. Press the dash () button. Enter the sub-channel number. (For example, to select digital channel 125-1, press 1, 2, 5, -, 1.) Press . |

## Using the Channel Browser™

The Channel Browser™ is a helpful navigational interface for all of your channels and inputs.

Features:

- Navigate the contents of all of your inputs.
- Keep a list of your favorite channels.
- Keep a history of the last 32 channels or inputs viewed.
- Quickly surf and tune to your recently viewed channels/inputs from the Channel Browser™ History List.
- Surf via Browse mode (to immediately tune to channels as you highlight them in the Channel Browser™) or Select mode (to surf channels in the Channel Browser™ before you select one to tune to).
- Quickly change inputs from the Inputs List.
- Quickly select HDMI® CEC devices from the HDMI-CEC List.

To set up the Channel Browser™:

- 1 > **Settings** > **PREFERENCES** > **Channel Browser Setup** > .
- 2 Press or to highlight **Navigation**.
- 3 Press or to select **Select Mode** or **Browse Mode**.
- 4 Select a list.
  - History List
  - ANT/CABLE List
  - Inputs List
  - Favorites List
  - HDMI-CEC List

**Note:**

- The History List will be cleared every time the TV is powered off.
- The HDMI-CEC List is not available when **Enable HDMI-CEC Control** is set to **Off** (p. 39).

- 5 Select **On** or **Off**.
- 6 To return to factory defaults, highlight **Reset** and press .

To open the Channel Browser™:

- > **APPLICATIONS** > **Channel Browser** > .
- Press or .

### Elements of the Channel Browser™

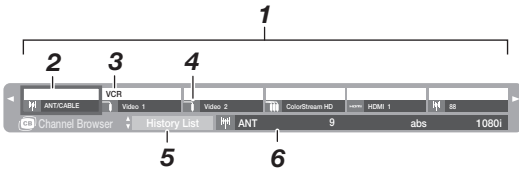

- 1 Channels stored in the current list
- 2 Channel or input that is currently highlighted in the browser
- 3 Inputs or channels labels
- 4 Input type
- 5 Current list (**History**, **ANT/CABLE**, **Inputs**, **Favorites**, or **HDMI-CEC**)
- 6 Channel or input currently being viewed

#### To cycle through the available lists:

- 1 Open the Channel Browser™.
- 2 Press ▲ or ▼.

#### Note:

- The **History List** opens by default. After selecting another list, the Channel Browser™ will open in the last selected list.
- If all lists are turned off, or will not display the Channel Browser™. If **Favorites List** is turned off, pressing will not display the Favorites Browser.
- Pressing opens the Channel Browser™ Favorites list regardless of the last selected list in the Channel Browser™.

#### To tune to a channel or input in Browse mode:

- 1 Highlight an item. The TV tunes to the channel or input.
- 2 Press to close the Channel Browser™.

#### To tune to a channel or input in Select mode:

- 1 Highlight the item you want to tune to.
- 2 Press .
- 3 Press to close the Channel Browser™.

### Favorites Browser

You can quickly create a favorite channels/inputs list that is integrated into the Channel Browser™.

#### To add a favorite channel or input:

- 1 Tune to the channel or input.
- 2 Press and hold for 3 seconds.

**Note:** Additions are added to the beginning of the Favorites list on the left side of the Channel Browser™.

#### To delete a favorite channel or input:

- 1 Press . The Favorites Browser list appears.
- 2 Select a channel or input by pressing ◀ or ▶.
- 3 Press and hold for 3 seconds.

### Adding and clearing channels and inputs in the History List

#### Adding channels to the History List:

As a channel or input is tuned, the Channel Browser™ adds it to the History List and displays it on the right side of the Channel Browser™.

Previously tuned channels and inputs shift to the left. Press ◀ to surf back through the previously tuned channels and inputs.

The Channel Browser™ stores these channels:

- Channels that are tuned using the numeric buttons on the remote control.
- Channels that are tuned for at least 5 seconds using or .

#### To clear channels from the History List:

- Reconfigure the **ANT/CABLE** input.
- Turn off the TV.

## Using Channel Return

You can switch between two channels without entering a channel number each time. This feature also works for external inputs.

- 1 Select the first channel you want to view.
- 2 Select a second channel using the Channel Number buttons (and the dash ([-]) button if needed).
- 3 Each time you press [CH RTN], the TV switches back and forth between the last two channels that were tuned.

## Using SurfLock™

The SurfLock™ feature temporarily memorizes one channel to the [CH RTN] button, so it can be quickly returned to from any other channel. This feature also works for external inputs.

To memorize a channel to the [CH RTN] button:

- 1 Tune to the channel you want to program to the [CH RTN] button.
- 2 Press and hold [CH RTN] for about 2 seconds until the message “Memorized” appears. The channel has been programmed to the [CH RTN] button.
- 3 You can then change channels repeatedly, and when you press [CH RTN], the memorized channel will be tuned.

After pressing [CH RTN] and then changing channels again, the memory is cleared and the button functions as Channel Return.

## Selecting the video input to view

To select the video input to view:

- 1 Press [INPUT] on the remote control or TV control panel.
- 2 Change the input:
  - Press 0–8.
  - Repeatedly press ▲ or ▼. Press [OK].
  - Repeatedly press [INPUT].

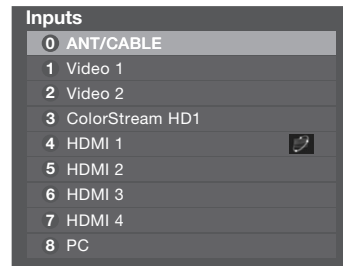

### Note:

- You can label the video input sources according to the specific devices you have connected to the TV (see “Labeling video inputs” on p. 30).
- You can skip sources (see “Skipping video inputs” on p. 29).
- Inputs that are set to be skipped will not be available and will be skipped when selecting inputs by repeatedly pressing [INPUT] or ▲ or ▼. They are only available by using direct number entry.
- If one or more HDMI® CEC devices are connected to an HDMI input, the icon appears in the input selector. In this case, the label (see p. 30) will not appear on the input selector.
- When the Auto Input feature is set, you can select a video input source with the remote control by pressing and holding the corresponding MODE SELECT button for 2 seconds (see p. 31).

To select an HDMI® CEC device:

- 1 Press ▲ or ▼ to select an HDMI input.
- 2 Press ►. The list of HDMI® CEC devices for that input appears.
- 3 If the input has multiple HDMI® CEC devices, use ▲ or ▼ to select a device.
- 4 Press [OK].

## Using closed captions

To turn on the closed caption mode:

- 1 > **Settings** > **SETUP** > **TV Settings** > .
- 2 Press or to select **Closed Captions Settings**. Press .
- 3 Press or to select **Closed Captions**.
- 4 Press or to select **On**.

**Note:** If **Closed Captions** is set to **Off**, **Analog CC Mode** and **Digital CC Settings** will be not available.

## Analog CC mode

The closed caption mode has two options:

| Mode     | Description  |
|----------|--|
| Captions | Displays the dialogue, narration, and sound effects of TV programs and videos that are closed captioned (usually marked "CC" in program guides). |
| Text     | Displays information not related to the current program, such as weather or stock data (when provided by individual stations).                   |

To view captions or text:

- 1 > **Settings** > **SETUP** > **TV Settings** > .
- 2 Press or to select **Closed Captions Settings**. Press .
- 3 Press or to select **Analog CC Mode**.
  - To view captions: Press or to highlight **CC1**, **CC2**, **CC3**, or **CC4**.



**Note:** If the program or video you have selected is not closed captioned, no captions will be displayed.

- To view text: Press or to highlight **T1**, **T2**, **T3**, or **T4**.

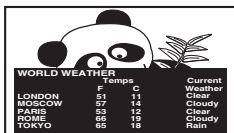

**Note:** If text is not available in your area, a black rectangle may appear on the screen. You may set **Closed Captions Settings** to **Off**.

**Note:** A closed caption signal may not display when a videotape is dubbed, signal reception is weak, or signal reception is non-standard.

## Digital CC settings

You can customize the closed caption display characteristics.

**Note:**

- These settings are available for digital channels only.
- You cannot set **Caption Text** and **Background** as the same color.

| Mode                    | Description   |
|-------------------------|---|
| Caption Size            | Auto, Small, Standard, Large  |
| Caption Text Type       | Auto, Mono w. Serif, Prop. w. Serif, Mono w/o Serif, Prop. w/o Serif, Casual, Cursive, Small Capitals |
| Caption Text Edge       | Auto, None, Raised, Depressed, Uniform, Left Drop Shadow, Right Drop shadow                           |
| Caption Text Color      | Auto, Black, White, Red, Green, Blue, Yellow, Magenta, Cyan   |
| Text Foreground Opacity | Auto, Transparent, Translucent, Flashing, Solid   |
| Background Color        | Auto, Black, White, Red, Green, Blue, Yellow, Magenta, Cyan   |
| Text Background Opacity | Auto, Transparent, Translucent, Flashing, Solid   |
| Caption Text Edge Color | Auto, Black, White, Red, Green, Blue, Yellow, Magenta, Cyan   |

To customize the closed captions:

- 1 > **Settings** > **SETUP** > **TV Settings** > .
- 2 Press or to select **Closed Captions Settings**. Press .
- 3 Press or to select **Digital CC Settings**. Press .
- 4 Press or to select a characteristic. Press or to select the format for that characteristic.

## Using the Closed Caption button

If you press when an analog channel is tuned or from an external input (480i signal from the video input):

- The CC bar will appear and will display CC1-4, T1-4, and Off as the options.

If you press when a digital channel is tuned:



- The CC bar will appear and will display the available caption options (available languages) for that channel or service.

## Setting the PIN code



A PIN code is necessary for some menus.

**Note:** The **Parental Control and Locks** menu is grayed out if no PIN has been set.



### Entering a new PIN code

- 1  > **Settings** > **PREFERENCES** > **PIN Setting** > .
- 2 Use the number buttons to enter a 4-digit number. Confirm the code.  
**Note:** The PIN code cannot be set to "0000".

### Changing or deleting your PIN code

- 1  > **Settings** > **PREFERENCES** > **PIN Setting** > .
  - 2 Use the number buttons to enter your 4-digit PIN code.
  - 3 Select **Change PIN** or **Delete PIN**. Press .
- Note:**
- The PIN code cannot be set to "0000".
  - If you delete the PIN code, the settings of **Parental Controls and Locks** are reset.

### Forgotten PIN code













- 1  > **Settings** > **PREFERENCES** > **PIN Setting** > .
- 2 Press  4 times within 5 seconds. The code is cleared.
- 3 Enter a new PIN code.

## Using parental controls

### Blocking TV programs and movies by rating (V-Chip)

Some TV programs and movies include signals that classify the content of the program as unsuitable for younger viewers. The V-Chip feature in this TV detects the signals and blocks the programs according to the ratings you select.

**Note:** The V-Chip feature in this TV supports the U.S. V-Chip system only.

- 1  > **Settings** > **PREFERENCES** > **Parental Control and Locks** > .
- 2 Enter your 4-digit PIN code.
- 3 Press  or  to highlight **Enable Rating Blocking**.
- 4 Press  or  to select **On**.
- 5 Press  to select **Edit Rating Limits**. Press . The **Edit Rating Limits** screen appears.
- 6 Press , ,  or .
- 7 Press  to select a level of blocking.  
A box with an "X" indicates a rating that will be blocked. As you highlight a rating, the rating's definition appears at the bottom of the screen.





**Note:** This feature will be not available if no PIN code is set.



## Downloading an additional rating system

In the future, an additional rating system may become available for use in selectively blocking TV programs and movies.

**Note:** The currently tuned station must be receiving a digital signal before an additional rating system can be downloaded.

- 1  > **Settings** > **PREFERENCES** > **Parental Control and Locks** > .
- 2 Enter your 4-digit PIN code. The **Parental Control and Locks** screen appears.
- 3 Press **▲** or **▼** to highlight **Enable Rating Blocking**.
- 4 Press **◀** or **▶** to select **On**.
- 5 Press **▼** to select **Edit Rating Limits**. Press . The **Edit Rating Limits** screen appears.
- 6 Select **Alt RS**. Press . The **Edit Alternate Ratings** screen appears.
 

**Note:**

  - The **Alt RS** button is only available if an additional rating system is currently available.
  - The download may take several minutes.
  - The information displayed on the **Alternate Ratings** screen depends on the configuration of the additional rating system available at the time of download.
- 7 Press **▲**, **▼**, **◀**, or **▶**.
- 8 Press  to select **the desired** level of blocking. A box with an "X" indicates **the** rating that will be blocked.

**Note:**

- You can only download the additional rating system once. You cannot download updates if they become available.
- The additional rating system is not designed, transmitted, or controlled by the TV or Toshiba, nor is the availability of an additional rating system determined or controlled by Toshiba. Similarly, the rating of programs in an additional rating system is not determined, transmitted, or controlled by the TV or Toshiba.
- The additional rating system is an evolving technology; therefore, availability, content, and format may vary.

## Rating system

| Independent rating system for broadcasters |  |
|--|--|
| Ratings                                    | Description and Content themes   |
| <b>TV-MA</b>                               | Mature Audience Only (This program is specifically designed to be viewed by adults and therefore may be unsuitable for children under 17.)<br><b>L</b> ) Crude or indecent language <b>S</b> ) Explicit sexual activity <b>V</b> ) Graphic violence  |
| <b>TV-14</b>                               | Parents Strongly Cautioned (This program contains some material that many parents would find unsuitable for children under 14 years of age.)<br><b>D</b> ) Intensely suggestive dialogue <b>L</b> ) Strong, coarse language <b>S</b> ) Intense sexual situations <b>V</b> ) Intense violence |
| <b>TV-PG</b>                               | Parental Guidance Suggested (This program contains material parents may find unsuitable for younger children.)<br><b>D</b> ) Some suggestive dialogue <b>L</b> ) Infrequent coarse language <b>S</b> ) Some sexual situations <b>V</b> ) Moderate violence                                   |
| <b>TV-G</b>                                | General Audience (Most parents would find this program suitable for all ages.)   |
| <b>TV-Y7, TV-Y7FV</b>                      | Directed to Older Children (This program is designed for children age 7 and above. Note: Programs in which fantasy violence may be more intense or more combative than other programs in this category are designated TV-Y7FV.)  |
| <b>TV-Y</b>                                | All Children (This program is designed to be appropriate for all children.)  |

| Independent rating system for movies |   |
|--------------------------------------|---|
| Ratings                              | Description and Content themes  |
| <b>X</b>                             | X-rated (For adults only)   |
| <b>NC-17</b>                         | Not intended for anyone 17 and under  |
| <b>R</b>                             | Restricted (Under 17 requires accompanying parent or adult)                           |
| <b>PG-13</b>                         | Parents Strongly Cautioned (Some material may be inappropriate for children under 13) |
| <b>PG</b>                            | Parental Guidance Suggested (Some material may not be suitable for children)          |
| <b>G</b>                             | General Audience (Appropriate for all ages)   |

| Indication other than rating system |                                    |
|-------------------------------------|------------------------------------|
| Display                             | Description                        |
| NONE                                | The program is rated None.         |
| (No rating appears)                 | No rating information is provided. |

**Note:**

- If you place an "X" in the box next to "Rated None", programs rated "None" or "Not Rated" will be blocked; Programs that do not provide any rating information will not be blocked.

## Displaying ratings

To display the rating of the program you are watching, press **INFO** on the remote control.

## Unlocking programs

If you try to tune to a program that exceeds the rating limits you have set, the TV will enter program lock mode and a warning message will appear onscreen. Follow the instructions to temporarily unlock the program.

## Locking specific channels

A channel that is configured as Locked cannot be viewed unless the PIN code is entered first (see "Setting the PIN code" on p. 36).

- 1 Press **MENU** > **Settings** > **SETUP** > **TV Settings** > **OK**.
- 2 Press **▲** or **▼** to select **Channel Options**. Press **OK**. The list of channels appears.

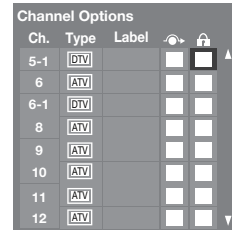

- 3 Press **▶** and then **▲** or **▼** to select a channel in the lock column, then press **OK**.
- 4 You must enter your PIN code to be able to lock channels.  
*Note: If no PIN code has been set, a warning appears.*
- 5 The box is selected. To clear the selection, press **OK**.

## Locking video input





You can lock video inputs and channels 3 and 4. You cannot view the input sources or channels until you unlock the inputs by entering the PIN code.

- 1 Press **MENU** > **Settings** > **PREFERENCES** > **Parental Control and Locks** > **OK**.
- 2 Enter your 4-digit PIN code.
- 3 Press **▲** or **▼** to highlight **Input Lock**.
- 4 Press **◀** or **▶** to select **Video**, **Video+**, or **Off**.

| Mode   | Description   |
|--------|---|
| Video  | Locks Video 1, Video 2, ColorStream HD1, ColorStream HD2, HDMI 1, HDMI 2, HDMI 3, HDMI 4, and PC.   |
| Video+ | Locks Video 1, Video 2, ColorStream HD1, ColorStream HD2, HDMI 1, HDMI 2, HDMI 3, HDMI 4, PC, and channels 3 and 4.<br>• Select <b>Video+</b> if you are playing video tapes via the ANT/CABLE input. |
| Off    | Unlocks all video inputs and channels 3 and 4.  |

## Setting a time limit for games

You can use the GameTimer® to set a time limit for playing a video game. When the time expires, the TV locks all external inputs.

- 1  > **Settings** > **PREFERENCES** > **Parental Control and Locks** > .
- (Another:  > **Timer** > **GameTimer** > .)
- 2 Enter your 4-digit PIN code.
- 3 Press **▲** or **▼** to select **GameTimer**.
- 4 Press **◀** or **▶** to select **30, 60, 90,** or **120** minutes.
- 5 To cancel the timer, select **Off**.

To deactivate the Input Lock once the GameTimer® has activated it:



Set the **Input Lock** to **Off** ( “Locking video input” on p. 38).

**Note:**

- A message appears when 10 minutes, 3 minutes, and 1 minute remaining.
- If the TV loses power with time remaining, the TV will enter Input Lock mode when power is restored (as if the GameTimer had been activated). You must deactivate the Input Lock ( “Locking video input”).

## Locking the control panel

You can lock the control panel to prevent your settings from being changed accidentally (by children, for example). When **Panel Lock** is set to **On**, none of the controls on the control panel operate except **POWER**.

- 1  > **Settings** > **PREFERENCES** > **Parental Control and Locks** > .
- 2 Enter your 4-digit PIN code.
- 3 Press **▲** or **▼** to select **Panel Lock**.
- 4 Press **◀** or **▶** to select **On**.

**Note:** When **Panel Lock** is set to **On**, “Panel Lock” appears onscreen when the buttons on the TV control panel are pressed. If the **POWER** button is pressed, the TV turns off and you must use the remote control to turn it on.



**To unlock the control panel:**

Select **Off** in Step 4 above.

## Using HDMI® CEC Control

This feature uses CEC technology and allows you to control Toshiba HDMI® CEC compatible devices from the TV remote control via HDMI connection. When **Enable HDMI-CEC Control** in the **HDMI-CEC Control Setup** menu is set to **On**, the following HDMI® CEC Control functions are enabled.

To set HDMI® CEC Control Setup:











- 1  > **Settings** > **PREFERENCES** > **HDMI-CEC Control Setup** > .
- 2 Press **▲** or **▼** to highlight **Enable HDMI-CEC Control**.
- 3 Press **◀** or **▶** to select **On**.  
*Note: If you set **Enable HDMI-CEC Control** to **Off**, the other items under HDMI-CEC Control Setup will be grayed out.*
- 4 Press **▲** or **▼** to select an item. Press **◀** or **▶** to select **On** or the desired mode.
  - TV Auto Power: On/Off
  - Auto Standby: On/Off
  - Amplifier Control: On/Off
  - Speaker Preference: TV Speakers/Amplifier

## Controlling HDMI® CEC playback devices

With your TV's remote control, you can control the connected HDMI® CEC playback device (DVD player, etc.) you are watching.

### Available remote control key functions:

Before using these key functions, set the MODE SELECT switch on the remote control to **TV**.

| Button  | Description                                    |
|---|--|
|  | Begins playback.                               |
|  | Stops playback.                                |
|  | Pauses the picture during play or record mode. |
|  | Skips forward.                                 |
|  | Skips backward.                                |
|  | Fast-forwards.                                 |
|  | Rewinds/reverses.                              |
|  | Navigates contents menu, etc.                  |
|  | Enters contents menu, etc.                     |
|  | Closes the menu.                               |
| RED,<br>GREEN,<br>YELLOW,<br>BLUE   | Controls various operations                    |

**Note:** These functions depend on the connected devices.

HDMI® CEC Player Control menu functions:

- 1 Press **QUICK** to open the Quick menu.
- 2 Select **HDMI-CEC Player Control**. Press **OK**.
- 3 Press **▲** or **▼** to select the item you want to control and press **OK**.

| Item          | Description   |
|---------------|---|
| Power         | Turns the selected device on and off.                 |
| Root Menu     | Accesses the selected device's top menu.              |
| Contents Menu | Accesses the contents list when you press <b>OK</b> . |
| Setup Menu    | Accesses the DVD player's setup menu.                 |

### Note:

- These functions depend on the connected devices.
- The **HDMI-CEC Player Control** item is not available under these conditions:
  - A non-HDMI input is selected.
  - The **Enable HDMI-CEC Control** item is set to **Off**.
  - The connected HDMI® CEC device is not a playback or recording device.

## HDMI® CEC Control input source selection

If an HDMI® CEC device with HDMI switching capability (e.g. an amplifier) is connected to the HDMI input, you can select another HDMI® CEC device that is connected to the master HDMI device.

Use **INPUT** on the remote control or the control panel ( p. 34).

## Adjusting the amplifier's audio

Using the TV's remote control, you can adjust or mute the sound volume of your amplifier. First, set the MODE SELECT switch on the remote control to **TV**.

- **[VOL]** adjust the volume level.
- **[MUTE]** turns off the sound.

**Note:** This feature is available when Amplifier Control is set to **On**.

**1** **[MENU]** > **Settings** > **PREFERENCES** > **HDMI-CEC Control Setup** > **[OK]**.

**2** Press **▲** or **▼** to highlight **Speaker Preference**.

**3** Press **◀** or **▶** to select **Amplifier**.

**Note:** Confirm that a connected HDMI® CEC device (such as DVD player, etc.) is selected for the Amplifier input source.

**Note:**

- You can also use this function when the amplifier is connected to the TV's **DIGITAL AUDIO OUT** terminal (not HDMI connection). Select a digital audio input mode on the amplifier.
- These functions depend on the device connected.

## Other HDMI® CEC Control functions

When **Enable HDMI-CEC Control** and all items in the **HDMI-CEC Control Setup** menu are set to **On**, the following functions will be enabled.

| Item               | Description  |
|--------------------|--|
| TV Auto Power      | If a HDMI® CEC device is turned on, the TV turns on automatically.   |
| Auto Standby       | If the TV is turned off, it will send a message to turn off all of the HDMI® CEC devices connected to the TV.  |
| Amplifier Control  | If Amplifier Control is set to <b>On</b> , you can adjust the sound volume or turn off the sound using the remote control.   |
| Speaker Preference | From this item, you can set your audio output preference to the TV speakers or the amplifier. When this item is set to <b>Amplifier</b> , the remote control can be used to adjust or mute the volume of the audio. This item will not be available and set to <b>TV Speakers</b> automatically unless a HDMI® CEC compatible audio receiver is connected. |

**Note:** When you turn on the amplifier, change its input source, or adjust the sound volume, the sound will be output from the amplifier's speakers even if **TV Speakers** has been selected. Turn the TV off and on again to output the sound from the TV speakers.

## Using the HDMI® settings feature

**Note:** If some HDMI legacy sources do not work properly with your HDMI TV, set INSTAPORT™ to **Off**. Adjusting this setting should allow your HDMI legacy source to operate properly with your TV.

| Mode (default setting) | Description  |
|------------------------|--|
| INSTAPORT™: On         | Reduces the lag time when switching HDMI sources.  |
| RGB Range: Auto        | Adjusts the RGB full range signal automatically. When <b>Limited</b> is selected, the RGB output signal is output in the range of 16 to 235. When <b>Full</b> is selected, the RGB output signal is output in the range of 0 to 255. |

The RGB Range setting requires appropriate HDMI source devices. If your HDMI source device does not support this feature, the TV may not work properly when it is enabled.

**Note:** If your HDMI connection is capable of 1080p and/or your TV is capable of refresh rates greater than 60 Hz, you will need a High Speed HDMI® cable. Conventional HDMI/DVI cables may not work properly with this mode.

- 1 Select the appropriate HDMI input mode (HDMI 1, HDMI 2, HDMI 3, or HDMI 4).
- 2 **[MENU]** > **Settings** > **PREFERENCES** > **AV Connection** > **[OK]**.
- 3 Press **▲** or **▼** to select **HDMI Settings**. Press **[OK]**.
- 4 Press **▲** or **▼** to select an item.
- 5 Press **◀** or **▶** to select a setting.

## Viewing the HDMI® signal information

- 1 **[MENU]** > **Settings** > **PREFERENCES** > **HDMI Information Display**.
- 2 Press **◀** or **▶** to select **On**. Press **[INFO]**. The normal banner and signal information banner appear.

**Note:**

- The signal information banner will appear when this feature is set to **On** and you watch an HDMI input.
- If you press **[INFO]** when this feature is set to **Off**, only the normal banner will appear.

## Using your PC with the TV

### Adjusting the image

If the edges of the picture are hidden, readjust **Horizontal Position** and **Vertical Position**. If the picture is affected by interference, readjust **Clock Phase** and **Sampling Clock**.

- 1 Select PC input mode (⏏ “Selecting the video input to view” on p. 34).
- 2 **MENU** > **Settings** > **PREFERENCES** > **Display Settings** > **OK**.
- 3 Press **▲** or **▼** to select **PC Settings**. Press **OK**.  
*Note:* If a PC is not connected or there is no PC input signal, this menu will not be available.
- 4 Press **▲** or **▼** to select an item.
- 5 Press **◀** or **▶** to make adjustments.  
*Note:* The screen is disrupted momentarily when adjusting the PC settings. This is not a sign of malfunction.

| Mode                | Description   | Adjustment range         |
|---------------------|---|--------------------------|
| Horizontal Position | Moves the picture left/right.   | within ±10 from center.* |
| Vertical Position   | Moves the picture up/down.  | within ±10 from center.* |
| Clock Phase         | Helps to reduce noise and sharpen the picture.                              | within ±15 from center.  |
| Sampling Clock      | Helps to reduce noise and minimize periodic vertical stripes on the screen. | within ±5 from center.   |

\* The default settings and /or adjustment ranges vary depending on the input signal format.

**To reset PC Settings:**  
Select **Reset**. Press **OK**.

### Setting the PC audio

You can output sound from your PC when connecting it to your TV, using the AUDIO IN terminal and PC audio cable.

- 1 **MENU** > **Settings** > **PREFERENCES** > **AV Connection** > **OK**.
- 2 Press **▲** or **▼** to select **Rear Shared Audio**.
- 3 Press **◀** or **▶** to select **PC**.

*Note:* Set **Shared PC Input** to **PC** to make the PC item selectable (⏏ p. 30).

## Setting the timer to turn on the TV

You can set the on timer to turn on the TV to a preset channel or input at a preset time.

**To activate the timer:**

- 1 **MENU** > **Settings** > **APPLICATIONS** > **On Timer** > **OK**.  
(Another: **MENU** > **Timer** > **On Timer** > **OK**.)
- 2 Press **▲** or **▼** to select **Enable On Timer**.
- 3 Press **◀** or **▶** to select **On**.

*Note:* If the Enable On Timer is set to **Off**, other menus under On Timer cannot be changed.

**To set the timer:**

- 1 **MENU** > **Settings** > **APPLICATIONS** > **On Timer** > **OK**.
- 2 Set these options to your preference:

| Item                | Description  |
|---------------------|--|
| Input               | Video input source.  |
| Channel             | Channel to view.   |
| Volume              | Volume level.  |
| Time until Power On | Desired length of time until the TV turns on.<br>minimum= 00:10, maximum= 12:00<br>• Press <b>◀</b> or <b>▶</b> .<br>• Use the number buttons. |

- 3 Select **Done**. Press **OK**.

*Note:* If you do not operate the TV for 1 hour after it is powered on by the On Timer feature, it turns off.

**To cancel the timer:**

- 1 **MENU** > **Settings** > **APPLICATIONS** > **On Timer** > **OK**.
- 2 Press **▲** or **▼** to select **Enable On Timer**.
- 3 Press **◀** or **▶** to select **Off**.

## Setting the sleep timer

You can set the TV to turn off after a specific amount of time (maximum = 12 hours).

Using the remote control:

- 1 Press **SLEEP**.
- 2 Set the time until the TV turns off.
  - Repeatedly press **SLEEP** to increase the time.
  - Press **▲** or **▼** to increase or decrease the time.

Using the onscreen menus:

- 1 **MENU** > **Settings** > **APPLICATIONS** > **Sleep Timer**.  
(Another: **MENU** > **Timer** > **Sleep Timer** > **OK**.)
- 2 Enter the time until the TV turns off.
  - Use the number buttons.
  - Press **▲** or **▼** to increase or decrease the time.

**Note:** If a power failure occurs, the sleep timer setting may be cleared.

**To display the time remaining until the TV turns off:**  
Press **SLEEP**.

**To cancel the sleep timer:**

Press **SLEEP** repeatedly or press **▲** or **▼** until it is set to 0 minutes.

## Setting Automatic Power Down

The TV can be configured to automatically turn itself off after 4 hours if you do not operate the TV either from the remote control or the TV control panel.

- 1 **MENU** > **Settings** > **PREFERENCES** > **Energy Saving Settings** > **OK**.
- 2 Press **▲** or **▼** to select **Automatic Power Down**.
- 3 Press **◀** or **▶** to select **On**. Press **EXIT**.

**Note:**

- 1 minute before switching to standby, a warning message will appear.
- When the following features are set, the feature that is set for the nearest time will function.
  - Automatic Power Down
  - Sleep Timer
  - Wallpaper/Auto Power Off
  - Auto shutdown after 1 hour of inactivity (after powering on by On Timer)
  - No signal auto power off (after 14 minutes of no signal)

## Setting No Signal Power Down

When an input's setting in this feature is set to On, The TV will automatically turn itself off after 14 minutes if no signal is detected.

You can change each input's setting to Off: ANT / CABLE, Video 1, Video 2, ColorStream HD1, ColorStream HD2, HDMI 1, HDMI 2, HDMI 3, HDMI 4, PC

- 1 **MENU** > **Settings** > **PREFERENCES** > **Energy Saving Settings**. Press **OK**.
- 2 Press **▲** or **▼** to select **No Signal Power Down**. Press **OK**.
- 3 Press **▲** or **▼** to highlight the item you want to change.
- 4 Press **◀** or **▶** to select **On** or **Off**. Press **EXIT**.

**Note:**

- Default setting for each input is **On**.
- A warning message will appear 1 minute before turning off.

## Displaying TV status information

To display TV status information:

Press **INFO**.

The following information will be displayed (if applicable):

- Current input (**ANT/CABLE, Video**, etc.)
- If ANT/CABLE is the current input, either “CABLE” (for cable TV) or “ANT” (for over-the-air broadcasts)
- Channel number (if in **ANT/CABLE** mode)
- Input label (if set)
- Digital signal strength indicator (bar graph in lower right corner of box; for ATSC signals only)
- Stereo, Mono, or SAP audio status (when in HDMI input mode, PCM)
- Video resolution
- Aspect ratio of incoming video signal (4:3 or 16:9)
- V-Chip rating status (if available)
- GameTimer (if set)
- Channel Label (if set or received)

To close the screen:

Press **INFO** again.

The following additional information (only available for **ANT/CABLE** input) will display for off-air digital channels (if applicable):

- Title
- Duration
- Detailed description

To display the next program's information for digital channels, press **INFO** again. Pressing **INFO** a third time will remove the entire banner.

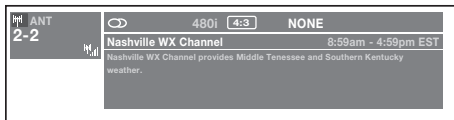

## Viewing support information

- 1 Press **MENU** > **Settings** > **SETUP** > **System Information**.
- 2 Press **OK** to display support information containing Web/Customer service numbers for US, Canada, and Mexico.

## Resetting to Factory Defaults

You can reset all settings and channels.

- 1 Press **MENU** > **Settings** > **SETUP** > **Reset TV** > **OK**.
- 2 Enter your PIN code (if a PIN code has been set).
- 3 A confirmation screen appears. Select **Yes**, and press **OK**. The TV will turn off automatically.

To cancel the reset:

Press **◀** or **▶** to select **No**. Press **OK**.

## Power failure

If power is lost while you are watching the TV, the **Last Mode Memory** feature automatically turns on the TV when power is restored.



## Selecting the picture size

You can view many program formats in several picture sizes—**Native**, **4:3**, **Full**, **TheaterWide 1**, **TheaterWide 2**, **TheaterWide 3**, **Normal**, and **Dot by Dot**.

**Note:** The picture size illustrations are examples only. The format of the image (in any of the picture sizes) depends on the format of the signal you are currently watching. Select the picture size that displays the current program in the way that looks best to you.

You can save separate picture size preferences for each input on your TV.

### To select the picture size:

- 1 Press **PIC SIZE**.
- 2 While the **Picture Size** screen is open, do one of the following:
  - Repeatedly press **PIC SIZE**.
  - Press the corresponding number button.
  - Press **▲** or **▼** and **OK**.

**Note:** Some picture sizes may not be available depending on the format of the signal being received.

Using these functions to change the picture size (i.e., changing the height/width ratio) for any purpose other than your private viewing may be prohibited under the Copyright Laws of the United States and other countries, and may subject you to civil and criminal liability.

**Note:** If you select a TheaterWide® picture size, the top and bottom edges of the picture (including subtitles or captions) may be hidden. To view these edges, adjust the **Picture Position** (📺 "Scrolling the picture" on p. 47) or try viewing the program in **4:3** or **Full**.

## Picture Size

**Native**  
(for 480i (HDMI), 480p (HDMI), 720p, 1080i, and 1080p signal programs)

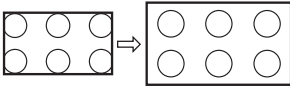

- If receiving a 1080i, 1080p, 720p, 480i (HDMI), or 480p (HDMI) signal program, the video is scaled to display the entire picture within the borders of the screen (i.e. no overscanning).
- This is especially useful for external HD sources such as DVHS movies, Video Games, or PC graphics.
- None of the picture is hidden.

**Note:**

- This mode is supported only for HDMI (1080i, 1080p, 720p, 480i, and 480p), ColorStream® (1080i and 720p), and ANT/CABLE (digital) inputs (1080i, 1080p, and 720p).
- Depending on the input signal, the picture's border may be hidden, displayed in black, or noisy.

**4:3**

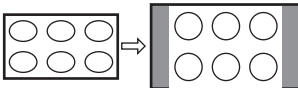
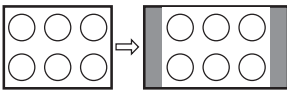

Some program formats will display with sidebars and/or bars at the top and bottom.

**Full**

(for 16:9 [480i, 480p] source programs only)

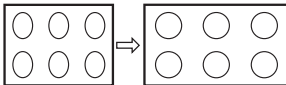

If receiving a squeezed 4:3 format program, the picture is stretched horizontally to fill the width of the screen but not stretched vertically.

(for 1080i, 1080p, and 720p program sources)

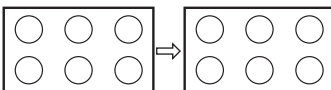

The edges of the picture may be hidden.

## Picture Size

**TheaterWide 1**  
(for 4:3 format programs)

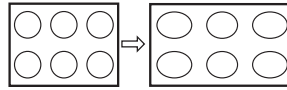

The center of the picture remains close to its original proportions, but the left and right edges are stretched horizontally to fill the screen.

**TheaterWide 2**  
(for letter box programs)

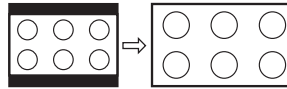

The picture's top and bottom edges may be hidden\*.

**TheaterWide 3**  
(for letter box programs with subtitles)

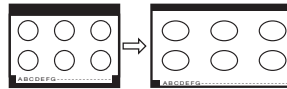

The picture's top and bottom edges are hidden\*.

**Normal**

(for VGA, SVGA, XGA, WXGA, and SXGA sources and Photo files)

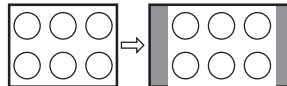

This size is a non-stretched display. Some input signal formats will display with sidebars and/or bars at the top and bottom.

**Dot by Dot**

(for VGA, SVGA, XGA, WXGA, and SXGA sources and Photo files)

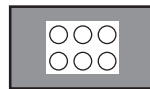

"Dot by Dot" is a non-scaling display. Depending on the input signal format, the picture is displayed with sidebars and/or bars at the top and bottom. (Example: VGA input source)

\* To view the hidden areas (such as subtitles or captions), see "Scrolling the picture" (p. 47).

## Scrolling the picture

If the edges of the picture are hidden, you can adjust the image's position.

**Note:**

- You can adjust the picture position when the picture size is set to **TheaterWide 2** or **TheaterWide 3**.
- When viewing DTV, **NET TV**, or **Media Player**, this feature is not available.

- 1 **MENU** > **Settings** > **PREFERENCES** > **Display Settings** > **OK**.
- 2 Press **▲** or **▼** to select **Picture Position**. Press **OK**.
- 3 Press **▲** or **▼** to select **Vertical Position**.
- 4 Press **◀** or **▶** to make the appropriate adjustments. The adjustment range is from **-5** to **+10**. Press **EXIT**.

## Using the Auto Aspect feature

When this feature is set to **On**, the TV will automatically select the picture size when one of the following input sources is received:

- A 480i, 480p, 720p, 1080i digital signal from the **ANT/CABLE** input
- A 480i signal from the **ColorStream HD** or **Video** input
- A 480i, 480p, 720p, 1080i, 1080p, or VGA (60/72/75 Hz) signal from the **HDMI 1/2/3/4** input

**Note:** The auto aspect ratio feature is not applicable to the PC input.

- 1 **MENU** > **Settings** > **PREFERENCES** > **Display Settings** > **OK**.
- 2 Press **▲** or **▼** to select **Auto Aspect**.
- 3 Press **◀** or **▶** to select **On**. Press **EXIT**.

## Using the 4:3 Stretch

When 4:3 Stretch is activated, the TV displays 4:3 programs as a full-screen picture.

**Note:** This feature is available when **Auto Aspect** is set to **On**.

- 1 **MENU** > **Settings** > **PREFERENCES** > **Display Settings** > **OK**.
- 2 Press **▲** or **▼** to select **4:3 Stretch**.
- 3 Press **◀** or **▶** to select **On**. Press **EXIT**.

## Freezing the picture

- 1 When watching the TV, press **FREEZE** to freeze the picture.
- 2 To unfreeze the picture, press **FREEZE** again.

**Note:** After 15 minutes, the picture will unfreeze automatically.

Using the FREEZE function for any purpose other than your private viewing may be prohibited under the Copyright Laws of the United States and other countries, and may subject you to civil and criminal liability.

## Adjusting the picture

### Selecting the picture mode

You can select your desired picture settings from the modes described below.

| Mode      | Description   |
|-----------|---|
| AutoView® | Automatically adjusts picture settings based on ambient light conditions and input signal content.                        |
| Sports    | Bright and dynamic picture.   |
| Standard  | Standard picture settings.  |
| Movie 1   | Lower contrast for darkened room.   |
| Movie 2   |   |
| Game      | Designed for playing a video game requiring split-second timing between the screen display and input from the controller. |
| PC        | Designed for the viewing of PC tables and documents.  |

**Note:**

- **PC** mode is available for HDMI and PC inputs only (not displayed for other input sources).
- **Game** mode cannot be turned on when the **ANT/CABLE** input is selected.

**1** > **Settings** > **PICTURE** > **Picture Mode**.

**2** Press or to select a mode. Press .

**Note:** The picture mode you select affects the current input only. You can select a different picture mode for each input.

### Adjusting the picture quality

The adjustments you make to picture quality under a picture mode are saved to that picture mode.

| Selection  | Pressing | Pressing |
|------------|----------|----------|
| Backlight* | darker   | lighter  |
| Contrast   | lower    | higher   |
| Brightness | darker   | lighter  |
| Color      | paler    | deeper   |
| Tint       | reddish  | greenish |
| Sharpness  | softer   | sharper  |

\* Backlight: Adjusts the brightness of the entire screen. When in video mode and no signal is input, this selection is set to 0. (Settings are stored in memory.)

**Note:** Some settings cannot be adjusted in any of the following cases.

- **AutoView** is selected.
- **TheaterLock** is set to **On**.

**To adjust the picture quality:**

**1** > **Settings** > **PICTURE** > the setting you would like to adjust (**Backlight, Contrast, Brightness, Color, Tint, or Sharpness**).

**2** Press or to adjust the setting. Press .

**Note:**

- Any picture settings that you adjust affect the current input only. You can adjust the picture quality separately for each input.
- Depending on a Sharpness value, the Edge Enhancer effect may be reduced.

**To reset to the factory defaults:**

**1** Select the picture mode you want to reset.

**2** > **Settings** > **PICTURE** > **Reset** > . A confirmation screen appears.

**3** Press or to select **Yes**. Press .













## Using the advanced picture settings features

**Note:** Some of the Advanced Picture Settings features will not be available for adjustment when the Picture Mode is set to **AutoView**.

### Edge Enhancer

The Edge Enhancer feature lets you adjust the levels for your desired picture settings and achieve a sharper picture.

To set Edge Enhancer:







- 1  > **Settings** > **PICTURE** > **Advanced Picture Settings** > .
- 2 Press  or  to select **Edge Enhancer**. Press .
- 3 Press  or  to select **On**.
- 4 Press  or  to highlight **Level**. Press  or  to select either **1**, **2**, **3**, **4**, or **5**. Press .

**Note:**

- When the Picture Mode is set to **AutoView**, the level range is from -2 to +2.
- If the Picture Mode is set to **Game** or **PC**, Edge Enhancer is not available.
- This feature may not work properly depending on the content.
- Noise may appear on the image depending on the device connected to the TV (e.g. a device with a specific enhancer function).

### Dynamic Contrast

Dynamic Contrast detects changes in picture quality that affect the appearance of your contrast settings and then automatically adjusts the video.

- 1  > **Settings** > **PICTURE** > **Advanced Picture Settings** > .
- 2 Press  or  to select **Dynamic Contrast**.
- 3 Press  or  to adjust the level. The adjustment range is from **0** to **10**. Press .

**Note:** When the Picture Mode is set to **AutoView**, the level range is from -5 to +5.

### DynaLight™







The DynaLight™ feature automatically strengthens the black coloring of dark areas in the video according to the level of darkness.

- 1  > **Settings** > **PICTURE** > **Advanced Picture Settings** > .
- 2 Press  or  to select **DynaLight**.
- 3 Press  or  to select **On** or **Off**. Press .

### Static Gamma







The static gamma feature lets you adjust the levels of black in the picture.

To adjust the static gamma settings:

- 1  > **Settings** > **PICTURE** > **Advanced Picture Settings** > .
- 2 Press  or  to select **Static Gamma**.
- 3 Press  or  to adjust the level. The adjustment range is within  $\pm 15$  from center. Press .

### Film Stabilization

This feature helps to eliminate video shaking.

- 1  > **Settings** > **PICTURE** > **Advanced Picture Settings** > .
- 2 Press  or  to select **Film Stabilization**.
- 3 Press  or  to select **Smooth**, **Standard**, or **Off**. Press .

**Note:** If the Picture Mode is set to **Game**, this feature will be set to **Off** automatically and grayed out.

## ClearFrame™ feature

The ClearFrame 120 Hz anti-blur technology doubles the frame rate from 60 frames per second to 120 frames per second, virtually eliminating motion blur without adding flicker or reducing image brightness.

- 1 **MENU** > **Settings** > **PICTURE** > **Advanced Picture Settings** > **OK**.
- 2 Press **▲** or **▼** to select **ClearFrame**.
- 3 Press **◀** or **▶** to select **On**. Press **EXIT**.

**Note:** If the Picture Mode is set to **Game**, this feature is not available.

## MPEG NR

The MPEG noise reduction feature allows you to reduce visible interference caused by MPEG compression.

- 1 **MENU** > **Settings** > **PICTURE** > **Advanced Picture Settings** > **OK**.
- 2 Press **▲** or **▼** to select **Noise Reduction**. Press **OK**.
- 3 Press **▲** or **▼** to highlight **MPEG NR**.
- 4 Press **◀** or **▶** to select either **Low**, **Middle**, **High**, or **Off**. Press **EXIT**.

**Note:** If the Picture Mode is set to **Game** or **PC**, this feature is not available.

## DNR

DNR lets you soften the screen representation of a weak signal to reduce the noise effect.

- 1 **MENU** > **Settings** > **PICTURE** > **Advanced Picture Settings** > **OK**.
- 2 Press **▲** or **▼** to select **Noise Reduction**. Press **OK**.
- 3 Press **▲** or **▼** to select **DNR**.
- 4 Press **◀** or **▶** to select **Low**, **Middle**, **High**, **Auto**, or **Off**. Press **EXIT**.

### **Note:**

- If the Picture Mode is set to **Game** or **PC**, this feature is not available.
- The differences may not always be noticeable. For the best results, use lower settings, as picture quality may be greatly reduced if the setting is too high.

## Auto Brightness Sensor

When the Auto Brightness function of Auto Brightness Sensor Settings is set to **On**, the TV optimizes the backlighting levels to suit ambient light conditions.

- 1 **MENU** > **Settings** > **PICTURE** > **Advanced Picture Settings** > **OK**.
- 2 Press **▲** or **▼** to select **Auto Brightness Sensor Settings**. Press **OK**.
- 3 Press **▲** or **▼** to select **Auto Brightness Sensor**.
- 4 Press **◀** or **▶** to select **On** or **Off**. Press **EXIT**.

**Note:** When the Picture Mode is set to **AutoView**, this feature is automatically set to **On** and will not be available.

## Backlight Adjustment Pro

This feature adjusts the backlight so that it can change to match the ambient light conditions.

- 1 **MENU** > **Settings** > **PICTURE** > **Advanced Picture Settings** > **OK**.
- 2 Press **▲** or **▼** to select **Auto Brightness Sensor Settings**. Press **OK**.
- 3 Press **▲** or **▼** to select **Backlight Adjustment Pro**. Press **OK**. The Backlight Control Level screen appears.
- 4 Press **OK** to display the adjustment window. Press **◀** or **▶** to select the point. Press **▲** or **▼** to adjust the level. The adjustment range is from **0** to **100**.

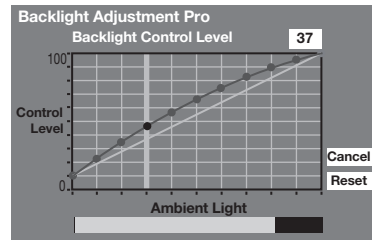

- 5 Press **OK** to fix the adjustment. To cancel the adjustment when selecting a point, select **Cancel** on the screen. To reset the adjustments of all points to the factory defaults, select **Reset** on the screen. Press **OK**.

**Note:** If the **Auto Brightness Sensor** is set to **Off**, this feature will not be available.

## ColorMaster™

The ColorMaster™ feature allows you to adjust standard colors.

- 1 **MENU** > **Settings** > **PICTURE** > **Advanced Picture Settings** > **OK**.
- 2 Press **▲** or **▼** to select **ColorMaster**, press **◀** or **▶** to select **On**. Press **EXIT**.

## Base Color Adjustment

When ColorMaster™ is set to **On**, the list of base colors appears. You can select a base color to adjust.

- 1 **MENU** > **Settings** > **PICTURE** > **Advanced Picture Settings** > **OK**.
- 2 Press **▲** or **▼** to select **Base Color Adjustment**. Press **OK**. The **Base Color Adjustment** screen appears.
- 3 Press **▲** or **▼** to select a color. Press **▶**.
- 4 Press **◀** or **▶** to select **Hue**, **Saturation**, or **Brightness**.
- 5 Press **▲** or **▼** to adjust the setting.
- 6 Repeat Steps 3 through 5 to adjust other colors. To reset the adjustments to the factory defaults, select **Reset** on the screen. Press **OK**.

## Color temperature

- 1 **MENU** > **Settings** > **PICTURE** > **Advanced Picture Settings** > **OK**.
- 2 Press **▲** or **▼** to select **Color Temperature**. Press **OK**.
- 3 Press **▲** or **▼** to select **Color Temperature**.
- 4 Press **◀** or **▶** to adjust the level. The adjustment range is 0 (warm) to 10 (cool). Press **EXIT**.

**Note:** When the Picture Mode is set to **AutoView**, the adjustment range is -5 to +5.

## Resetting to the factory default

- 1 **MENU** > **Settings** > **PICTURE** > **Advanced Picture Settings** > **OK**.
- 2 Press **▲** or **▼** to select **Reset**. Press **OK**. A confirmation screen appears.
- 3 Select **Yes**. Press **OK**.

## Setting the Expert Picture Settings

### Test Pattern

When the test pattern is on screen, you can navigate the Picture submenus without removing the image. When you move to a non-Picture menu, or close the menus, regular video will be restored.

- 1 **MENU** > **Settings** > **PICTURE** > **Expert Picture Settings** > **OK**.
- 2 Select **Test Pattern**.
- 3 Press **◀** or **▶** to select **On**.
- 4 Adjust picture settings.

### RGB Filter

This feature individually enables or disables the red, green, and blue components of the picture to allow for more accurate adjustment of each color.

- 1 **MENU** > **Settings** > **PICTURE** > **Expert Picture Settings** > **OK**.
- 2 Press **▲** or **▼** to select **RGB Filter**. Press **OK**.
- 3 Press **▲** or **▼** to select **Red**, **Green**, or **Blue** to adjust.
- 4 Press **◀** or **▶** to select **On**.
- 5 Press **▼** to select **Color** or **Tint**, press **◀** or **▶** to adjust. Press **EXIT**.

**Note:** It is not possible to turn off all three colors simultaneously.

### White Balance

#### Window Display

This feature displays the Window Pattern to adjust the white balance with a measuring device.

- 1 **MENU** > **Settings** > **PICTURE** > **Expert Picture Settings** > **OK**.
- 2 Press **▲** or **▼** to select **White Balance**. Press **OK**.
- 3 Press **▲** or **▼** to select **Window Display**.
- 4 Press **◀** or **▶** to select **On**.
- 5 Adjust picture settings.

## Setting Type

You can adjust the white balance setting.

- 1 **MENU** > **Settings** > **PICTURE** > **Expert Picture Settings** > **OK**.
- 2 Press **▲** or **▼** to select **White Balance**. Press **OK**.
- 3 Press **▲** or **▼** to select **2P White Balance**. Press **OK**.
- 4 Press **▲** or **▼** to select **Red-Offset**, **Green-Offset**, **Blue-Offset**, **Red-Gain**, **Green-Gain**, or **Blue-Gain**. Press **◀** or **▶** to adjust. Press **EXIT**.

## Copy to All Inputs

This feature copies White Balance on the current input to all other inputs. Individual settings that are not allowed for a specific input will not be copied.

- 1 **MENU** > **Settings** > **PICTURE** > **Expert Picture Settings** > **OK**.
- 2 Press **▲** or **▼** to select **White Balance**. Press **OK**.
- 3 Press **▲** or **▼** to select **Copy to All Inputs**. Press **OK**. A confirmation screen appears.
- 4 Select **Yes**. Press **OK**.

## Resetting to the factory default

- 1 **MENU** > **Settings** > **PICTURE** > **Expert Picture Settings** > **OK**.
- 2 Press **▲** or **▼** to select **Reset**. Press **OK**. A confirmation screen appears.
- 3 Select **Yes**. Press **OK**.

## Locking the picture settings

The TheaterLock™ feature lets you lock items in the **PICTURE** menu that affect the picture's display. These items cannot be modified when **TheaterLock** is set to **On**.

- 1 **MENU** > **Settings** > **PICTURE** > **TheaterLock**.
- 2 Press **◀** or **▶** to select **On**. Press **EXIT**.

## Adjusting the audio

### Muting the sound

Press **MUTE** to partially reduce (1/2 Mute) or turn off (Mute) the sound. Each time you press **MUTE**, the mute mode changes in the following order:



If the closed caption mode is set to **Off** when you select **MUTE** mode, the closed caption feature becomes active if the TV program is closed-captioned. To mute the audio without activating the closed captioning, press **VOCH** to set the volume to 0.

**Note:** If you modify items in the **SOUND** menu while **Mute** is active, **Mute** is cancelled.

### Selecting stereo/SAP broadcasts

The MTS (multi-channel TV sound) feature is only available for analog signals on the **ANT/CABLE** input. When the TV receives a stereo or SAP (second audio program) broadcast, the icon **STEREO** or **SAP** appears onscreen when **INFO** is pressed.

To listen in stereo sound:

- 1 **MENU** > **Settings** > **SOUND** > **MTS**.
- 2 Press **◀** or **▶** to select **Stereo**. Press **EXIT**.

**Note:**

- You can typically leave the TV in **Stereo** mode because it outputs the type of sound being broadcast (stereo or monaural).
- If the sound is noisy, select **Mono**.

To listen to a second audio program on an analog station (if available):

If provided by individual analog stations, you can listen to a second audio program containing another language, music, or other audio information. For example, you will hear the other language instead of the program's normal audio.

- 1 **MENU** > **Settings** > **SOUND** > **MTS**.
- 2 Press **◀** or **▶** to select **SAP**. Press **EXIT**.

**Note:** If there is no sound in **SAP** mode, select **Stereo**.



## Using the MTS button

If you press  when an analog channel is tuned:

- The Analog Audio bar will appear and display Stereo, SAP, Mono as the options.

If you press  when a digital channel is tuned:





- The Digital Audio bar will appear and offer different audio choices for the digital channel.

If you press  when an external input is selected:

- No Audio bar is displayed.





## Adjusting the audio balance

You can adjust the audio balance.

- 1  > **Settings** > **SOUND** > **Balance**.
- 2 Press  or  to adjust. Press .







## Adjusting the range

You can adjust bass and treble.

- 1  > **Settings** > **SOUND** > **Bass** or **Treble**.
- 2 Press  or  to adjust. Press .

## Selecting the optical audio output format



You can select the optical audio output format when you connect a Dolby Digital decoder or other digital audio systems to the TV's **DIGITAL AUDIO OUT** terminal.

- 1 Tune to a digital source on the **ANT/CABLE** input.
- 2  > **Settings** > **PREFERENCES** > **AV Connection** > .
- 3 Press  or  to select **Digital Audio Output**.
- 4 Press  or  to select **Auto** or **PCM**. Press .

| Option | Description  |
|--------|--|
| Auto   | Outputs Dolby Digital to the digital audio output if it is being broadcast; otherwise, it outputs PCM. |
| PCM    | Outputs PCM format to the digital audio output socket.   |

## Using the Dolby® Digital Dynamic Range Control feature

You can further compress Dolby Digital and Dolby Digital Plus dynamic range so you can switch from digital to analog broadcasts at the same dynamic range.



- 1  > **Settings** > **SOUND** > **Dynamic Range Control**.
- 2 Press  or  to select **On**.

**Note:**

- This feature is available when Dolby Digital or Dolby Digital Plus is input to the TV in the following situations:
  - When tuned to a digital RF channel.
  - When an HDMI input is used.
  - When DLNA Certified products or widgets are used.
- This feature is automatically set to **Off** when **Dynamic Volume (Audyssey Dynamic Volume®)** is set to **Low** or **High**.
- This feature will also affect **Digital Audio Output** when the optical audio output format is set to **PCM**.

## Using Audyssey Dynamic Volume®

This feature provides a consistent sound volume between television programs, commercials, and between the loud and soft passages of movies.

- 1  > **Settings** > **SOUND** > **Dynamic Volume**.
- 2 Press  or  to select **Low**, **High**, or **Off**.

**Note:**

- If **Dynamic Range Control** is set to **On**, this feature is automatically set to **Off**.
- This feature does not affect the audio signal output from the **DIGITAL AUDIO OUT** terminal.

## Using advanced sound features

### Using surround sound

Voice Enhancement and Dynamic Bass Boost help to create a thrilling surround sound experience with deep, rich bass from stereo sound sources. Your TV's audio will sound fuller, richer, and wider.

**Note:** Surround features are only available for **Stereo** mode (📺 "Selecting stereo/SAP broadcasts" on p. 52).

**1**  > **Settings** > **SOUND** > **Advanced Sound Settings** > .

**2** Press ▼ or ▲ to highlight the feature to adjust. Press ◀ or ▶ to adjust the item.

| Mode               | Description  |
|--------------------|--|
| Voice Enhancement  | Turns the vocal emphasis effect <b>On</b> or <b>Off</b> .                    |
| Dynamic Bass Boost | Selects a bass expansion level ( <b>Off</b> , <b>Low</b> , or <b>High</b> ). |

# Chapter 8: Advanced features

The relation of DMR was deleted in this chapter.

## Using your home network

- This TV is a DLNA CERTIFIED™ Player. It can play digital content stored on a DLNA CERTIFIED™ product with server functions.  
If you want to use this TV as a DLNA CERTIFIED™ Player, you will have to configure the network settings on your TV (☞ p. 21).
- If you want to use your home network with an Internet connection, you will have to configure the network settings on your TV (☞ p. 21).  
Change the network settings if necessary (☞ “Setting up the Network” on p. 56).

### If you use Internet services, see the following note before use.

Third party Internet services are not provided by Toshiba, may change or be discontinued at any time, and may be subject to third party restrictions. Toshiba makes no warranties, representations, or assurances about the content, availability, or functionality of third party content or services. Third party internet services may require the creation of a separate account through a computer with internet access, and payment of one-time and/or recurring charges.  
Certain features currently not available in Canada/ Mexico.

### When using a Wireless network connection:

#### Wireless LAN and your Health:

Wireless LAN products, like other radio devices, emit radio frequency electromagnetic energy. However, the level of energy emitted by Wireless LAN devices is much less than the electromagnetic energy emitted by wireless devices like mobile phones.

Because Wireless LAN products operate within the guidelines found in radio frequency safety standards and recommendations, Toshiba believes Wireless LAN is safe for use by consumers. These standards and recommendations reflect the consensus of the scientific community and result from deliberations of panels and committees of scientists who continually review and interpret the extensive research literature.

In some situations or environments, the use of Wireless LAN may be restricted by the proprietor of the building or responsible representatives of the organization. Such restrictions may apply in environments where the risk of interference to other devices or services is perceived or identified as harmful.

If you are uncertain of the policy that applies to the use of wireless devices in a specific organization or environment, you are encouraged to ask for authorization to use the Wireless LAN device prior to turning on the equipment.

#### Using in a wireless LAN environment:

- It is recommended to use IEEE 802.11a or IEEE 802.11n on 5 GHz for audio and SD video streaming.
- It is recommended to use IEEE 802.11n on 5 GHz for HD video streaming.
- It is recommended that the encoding rate of video content be 20 Mbps or less.
- It is not recommended to use 2.4 GHz for audio and video streaming.
- Content playback may be interrupted by surrounding interference.

## Setting up the Network

You can select the Network Type.

- 1 **MENU** > **Settings** > **PREFERENCES** > **Network Setup** > **OK**.  
(Another: **MENU** > **Network** > **Network Setup** > **OK**.)
- 2 Press **▲** or **▼** to highlight **Network Type**.
- 3 Press **◀** or **▶** to select **Wired** or **Wireless**.
- 4 If you select **Wired**, see “Advanced Network Setup” (p. 58).  
If you select **Wireless**, see the next section.

## Wireless Setup

### Note:

- Continued AP (Access Point) connection is not guaranteed. Connection may be lost while watching TV.

There are 3 methods for wireless setup:

- **Easy Setup** (WPS)  
If the AP supports WPS, this can be used.
  - WPS is a standard designed to simplify the connection of wireless LAN equipment and the setup of network security features.
- **Assisted Setup** (setup using the AP's notification information)  
Network Name, Authentication, and Encryption are decided based on information from the AP. You need to manually set the Security Key.
- **Manual Setup** (to input all settings)

## Easy Setup using PBC (Push Button Configuration)

- 1 **MENU** > **Settings** > **PREFERENCES** > **Network Setup** > **OK**.
- 2 Press **▲** or **▼** to select **Wireless Setup**. Press **OK**.
- 3 Press **▲** or **▼** to select **Easy Setup**. Press **OK**.
- 4 Press **◀** or **▶** to select **PBC**.
- 5 Press **▼** to select **Start Scan**. Press **OK**.
- 6 Following the onscreen instructions, push the appropriate button on your AP.
- 7 When a screen reporting that the setup has succeeded appears, press **OK**.

### To cancel searching for the AP:

Press **RETURN** while searching for the AP. A message will appear. Press **◀** or **▶** to select **Yes**. Press **OK**.

## Easy Setup using a PIN (Personal Identification Number)

- 1 **MENU** > **Settings** > **PREFERENCES** > **Network Setup** > **OK**.
- 2 Press **▲** or **▼** to select **Wireless Setup**. Press **OK**.
- 3 Press **▲** or **▼** to select **Easy Setup**. Press **OK**.
- 4 Press **◀** or **▶** to select **PIN**.
- 5 Press **▼** to select **Start Scan**. Press **OK**.
- 6 Scan screen appears. Enter the PIN displayed on this screen into your PC or AP.
- 7 Press **▲** or **▼** to select the desired AP. Press **OK**.  
**Note:** Check the MAC address on the label or in the manual of the AP and select an AP.
- 8 When a screen reporting that the setup has succeeded appears, press **OK**.

### To cancel searching for the AP:

Press **RETURN** while searching for the AP. A message will appear. Press **◀** or **▶** to select **Yes**. Press **OK**.

## Assisted Setup

- 1 **MENU** > **Settings** > **PREFERENCES** > **Network Setup** > **OK**.
- 2 Press **▲** or **▼** to select **Wireless Setup**. Press **OK**.
- 3 Press **▲** or **▼** to select **Assisted Setup**. Press **OK**.
- 4 Press **▲** or **▼** to select the desired AP. Press **OK**.  
**Note:** Check the MAC address on the label or in the manual of the AP and select an AP.
- 5 Select **Security Key**. Press **OK**. The Software Keyboard appears.
- 6 Input the Security Key using the Software Keyboard (p. 59). To save your settings, press the **BLUE** button.  
**Note:** The Security Key must adhere to these conditions:
  - TKIP/AES: 8-63 ASCII or 64 Hex characters
  - WEP: 5 or 13 ASCII or 10 or 26 Hex characters
- 7 Select **Done**. Press **OK**.

**Note:** Settings are not saved if **RETURN** is pressed before **Done** is selected.

### Manual Setup

- 1 > **Settings** > **PREFERENCES** > **Network Setup** > .
- 2 Press **▲** or **▼** to select **Wireless Setup**. Press .
- 3 Press **▲** or **▼** to select **Manual Setup**. Press .
- 4 Press **▲** or **▼** to select **Network Name**. Press . The Software Keyboard window appears.
- 5 Input the Network Name using the Software Keyboard ( p. 59). To save your settings, press the **BLUE** button.
- 6 Press **▲** or **▼** to highlight **Authentication**. Press **◀** or **▶** to select **Open/Shared**, **WPA-PSK**, or **WPA2-PSK**.
- 7 Press **▲** or **▼** to highlight **Encryption**. Press **◀** or **▶** to select **None**, **WEP**, **TKIP**, or **AES**.

**Note:**

- Certain encryption types are only compatible with specific authentication types.
  - When Authentication is Open/Shared, only WEP or None are compatible.
  - When Authentication is WPA-PSK or WPA2-PSK, only TKIP or AES are compatible.
- When incompatible Authentication/Encryption pairings are attempted, a warning message will be displayed, and no connection attempt will be made until the incompatibility is resolved.

- 8 Press **▲** or **▼** to select **Security Key**. Press . The Software Keyboard window appears.
  - 9 Input the Security Key using the Software Keyboard ( p. 59). To save your settings, press the **BLUE** button.
- Note:** This item is grayed out when **Encryption** is **None**.
- 10 Select **Done**. Press .

**Note:** When **Encryption** is **None**, a message will appear. Press **◀** or **▶** to select **Yes**. Press .

**Note:** Settings are not saved if is pressed before **Done** is selected.

### Wireless Information

The settings configured in **Wireless Setup** can be confirmed.

- 1 > **Network** > **Wireless Information** > .
- 2 A Wireless Information screen will appear.

**Note:** Press the **RED** button to check the availability of surrounding APs.

| Item            | Description  |
|-----------------|--|
| Status          | <b>Connected</b> is displayed when the TV is connected to the AP.<br><b>Disconnected</b> is displayed when the TV is disconnected from the AP. |
| Signal          | Connection signal strength with the AP ( <b>STRONG/MEDIUM/WEAK</b> )   |
| Speed           | The link speed with the AP   |
| Mode            | Working mode (11a, 11b, 11g, 11n)  |
| Channel         | The channel in use (1-165)   |
| Network Name    | SSID set   |
| Authentication  | Authentication set   |
| Encryption      | Encryption set   |
| Security Key    | Security Key set   |
| AP MAC Address  | The AP's MAC address is displayed when the TV is connected to the AP.  |
| TV MAC Address  | The TV's MAC address   |
| DHCP            | <b>Enabled</b> is displayed when you use DHCP.<br><b>Disabled</b> is displayed when you do not use DHCP.                                       |
| IP Address      | The TV's IP address  |
| Subnet Mask     | Value of the Subnet Mask   |
| Default Gateway | Default GATEWAY's address  |
| DNS             | DNS's address  |

**Note:** Even if an AP for IEEE 802.11n is used when **Encryption** is set to **WEP** or **TKIP**, the Speed value might be low. We recommend that the **Encryption** setting be changed to **AES** (Under manual setup).

## Advanced Network Setup

### Note:

- When the DHCP function of the router connected to this TV is On, you can set **Auto Setup** to On or Off. (Usually set it to **On**.)
- When the DHCP function of the router is Off, set **Auto Setup** to **Off**, and manually set the IP Address or DNS Address.

### IP Address Setup

**Note:** The settings in Auto Setup is linked to that selected in the DNS Setup menu. If Auto Setup is set to On, then Auto Setup in the DNS menu will also be set to On.

#### Auto Setup:

- 1 **MENU** > **Settings** > **PREFERENCES** > **Network Setup** > **OK**.
- 2 Press **▲** or **▼** to select **Advanced Network Setup**. Press **OK**.
- 3 Press **▲** or **▼** to select **IP Address Setup**. Press **OK**.
- 4 Select **Auto Setup**. Press **◀** or **▶** to select **On**.

**Note:** Other items will be grayed out when **Auto Setup** is set to **On**.

#### Manual Setup:

- 1 **MENU** > **Settings** > **PREFERENCES** > **Network Setup** > **OK**.
- 2 Press **▲** or **▼** to select **Advanced Network Setup**. Press **OK**.
- 3 Press **▲** or **▼** to select **IP Address Setup**. Press **OK**.
- 4 Select **Auto Setup**. Press **◀** or **▶** to select **Off**.
- 5 Press **▲** or **▼** to highlight **IP Address**.
- 6 Press **◀** or **▶** to highlight the field you want to change and use the number buttons to input the IP address. To save the setting, press **OK**.

#### Note:

- IP address field numbers must be between 0 and 255. If you input an incompatible number and press **OK**, the field number will be reset to the previous value.
- 7 Press **▲** or **▼** to highlight **Subnet Mask**, and edit in the same way as IP Address.
  - 8 Press **▲** or **▼** to highlight **Default Gateway**, and edit in the same way as IP Address.

**Note:** If you manually set the IP address, you must not use the same IP address for any other device. The IP address you use should be a private address. If you do not know the correct values to use, please contact your network administrator or internet service provider.

## DNS Setup

### Note:

- When the DHCP function of the router connected to this TV is Off, set **Auto Setup** to **Off**, and manually set the DNS address(es). Your internet service provider should have provided these to you.
- The settings in Auto Setup is linked to that selected in the IP Address Setup menu. If Auto Setup is set to On, then Auto Setup in the UP Address Setup menu will also be set to On.

#### Auto setup:

- 1 **MENU** > **Settings** > **PREFERENCES** > **Network Setup** > **OK**.
- 2 Press **▲** or **▼** to select **Advanced Network Setup**. Press **OK**.
- 3 Press **▲** or **▼** to select **DNS Setup**. Press **OK**.
- 4 Select **Auto Setup**. Press **◀** or **▶** to select **On**.

**Note:** Other items will be grayed out when **Auto Setup** is set to **On**.

#### Manual setup:

- 1 **MENU** > **Settings** > **PREFERENCES** > **Network Setup** > **OK**.
- 2 Press **▲** or **▼** to select **Advanced Network Setup**. Press **OK**.
- 3 Press **▲** or **▼** to select **DNS Setup**. Press **OK**.
- 4 Select **Auto Setup**. Press **◀** or **▶** to select **Off**.
- 5 Press **▲** or **▼** to highlight **Primary DNS Address**.
- 6 Press **◀** or **▶** to highlight the field you want to change, and then use the number buttons to input the Primary DNS Address. To save the setting, press **OK**.

#### Note:

- DNS address field numbers must be between 0 and 255. If you input an incompatible number and press **OK**, the field number will be reset to the previous value.
- 7 Press **▲** or **▼** to highlight **Secondary DNS Address**, and edit in the same way as Primary DNS Address.

## MAC Address

You can view the fixed MAC address for the TV.

- 1 **MENU** > **Settings** > **PREFERENCES** > **Network Setup** > **OK**.
- 2 Press **▲** or **▼** to select **Advanced Network Setup**. Press **OK**.
- 3 Press **▲** or **▼** to select **MAC Address**. Press **OK**.

## Network Connection Test

This function checks Internet connectivity.

- 1 **MENU** > **Settings** > **PREFERENCES** > **Network Setup** > **OK**.
- 2 Press **▲** or **▼** to select **Network Connection Test**. Press **OK**.  
**Note:** A message will appear to indicate whether the connection was successful or not.

**Note:** Favorable Network Connection Test results do not guarantee an Internet Connection. Depending on the situation, some Internet features may not be available.

### To cancel Network Connection Test:

Press **EXIT** while searching for the Internet connection.

## Using the software keyboard

You can enter text using the Software Keyboard. The Software Keyboard window will appear when you press **OK** on a field that accepts character input.

**Note:** When using the NET TV feature, software keyboard availability depends on the internet service being accessed.

### To enter text using the software keyboard:

- 1 Highlight the desired character on the onscreen software keyboard.
- 2 Press **OK**.
- 3 Repeat Steps 1 and 2 until you have entered all desired text.
- 4 Press the **BLUE** button to save your settings and return to the previous screen.

**Note:** If **RETURN** is pressed, changes are not saved and the software keyboard window is closed.

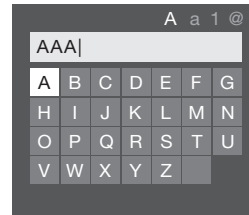

### Input operation on the remote control:

| Button         | Description  |
|----------------|--|
| <b>OK</b>      | Inputs the selected character.   |
| 0–9            | Inputs the number directly.  |
| <b>▲ ▼ ◀ ▶</b> | Moves the character highlight.   |
| <b>◀▶</b>      | Moves the cursor.  |
| <b>◀◀</b>      | Moves the cursor to the head of a character string.                        |
| <b>▶▶</b>      | Moves the cursor to the end of a character string.                         |
| <b>RED</b>     | Deletes 1 character to the left of the cursor.                             |
| <b>GREEN</b>   | Cycles through upper case, lower case, numbers, and symbols, if available. |
| <b>YELLOW</b>  | Chooses an accented version of the current letter, if applicable.          |
| <b>BLUE</b>    | Saves changes and closes the Software Keyboard window.                     |
| <b>RETURN</b>  | Closes the Software Keyboard window without saving changes.                |

## Performing a Software Upgrade

TOSHIBA may offer upgrades for the TV's software in the future. The TV's software is upgraded via Internet connection.

### Before downloading software:

Configure your TV to connect to the Internet.

#### Note:

- You will not be able to use the TV set while the upgrade is being performed.
- Do not turn off the TV during the upgrade.
- By upgrading, the factory default values may be changed.

1 Press **MENU** > **Settings** > **SETUP** > **Software Upgrade** > **OK**.

2 **Network Upgrade** is displayed. Press **OK**.

**Note:** If the network is not available, a warning message will appear.

3 After a successful download, the TV software upgrade will start automatically.

## Viewing the Software Licenses

The Licenses for the software used in this TV are available for viewing.

1 Press **MENU** > **Settings** > **SETUP** > **Software Licenses** > **OK**.

A screen will appear displaying all the licensing information required for the television's software.

## Using the NET TV™ feature

### Note:

- You need to connect to the Internet before using this feature (see p. 21).
- Services may not be currently available in your area.
- User registration or login may be required to use some services.

## NET TV menu

1 Press **NET TV**.  
(From the Menu: **MENU** > **Network** > **NET TV** > **OK**.)

2 Press **◀** or **▶** to select an icon. Press **OK**.



### Note:

- When you access the NET TV menu for the first time, a welcome screen appears (see "Guided Setup" below). After setup is complete, this feature is available.
- If the display of the date and time is wrong, turn off the TV, and turn it on again.
- NET TV menu items may change in the upgrade process.

## Guided Setup

The first time you use Yahoo! TV Widgets this step-by-step wizard begins with the Welcome Screen.

1 Select **Let's get started!**

If you select **Exit Setup** now, this step will resume the next time you press **OK**.



2 Follow the onscreen instructions.

### After completing the Guided Setup:

- When you press **NET TV** or select **NET TV** from the Menu, the NET TV menu is displayed.
- When you press **Widgets** or select **Widgets** from the Menu, the TV Widgets user interface is displayed.



## Netflix

### Watching movies with Netflix

- 1 Press **NETFLIX** (→ Step 3) or press **NET TV**.  
(From the Menu: **MENU** > **Network** > **NET TV** > **OK**.)
- 2 Press **◀** or **▶** to select Netflix icon. Press **OK**.
- 3 Follow the onscreen instructions.

After having activated Netflix player and prepared Instant Queue, movies and TV episodes in your Instant Queue will appear on the TV screen. Select the desired content using the remote control.

#### Note:

- The resolution of video content streamed from Netflix varies depending on the communication speed and bit-rate.
- Future upgrades can change the screens and messages displayed in the Netflix feature.

#### To close Netflix:

Press **EXIT**.

#### To confirm the Netflix ESN (Electronic Serial Number):

- 1 **MENU** > **Settings** > **PREFERENCES** > **Netflix Setup** > **OK**.
- 2 Press **▲** or **▼** to select **ESN**. Press **OK**.  
Netflix ESN is displayed.

#### To deactivate your device:

- 1 **MENU** > **PREFERENCES** > **Netflix Setup** > **OK**.
- 2 Press **▲** or **▼** to select **Deactivation**. Press **OK**.
- 3 Press **◀** or **▶** to select **Yes**. Press **OK**.

## VUDU™

VUDU™ is an on-demand service that offers high-definition movies on the Web.

- 1 Press **NET TV**.  
(From the Menu: **MENU** > **Network** > **NET TV** > **OK**.)
- 2 Press **◀** or **▶** to select **VUDU**. Press **OK**.

**Note:** Use of VUDU requires a working broadband internet connection (1 to 2 Mbps for SD video, 2.25 to 4.5 Mbps for HD video, and 4.5 to 9 Mbps for HDX video).

#### To close VUDU:

Press **EXIT**.

#### To deactivate your device:

- 1 **MENU** > **PREFERENCES** > **VUDU Deactivation** > **OK**.
- 2 Press **◀** or **▶** to select **Yes**. Press **OK**.

## YouTube™

YouTube is a video-sharing service managed by YouTube, LLC.

This TV allows you to view YouTube video content.

- 1 Press **NET TV**.  
(From the Menu: **MENU** > **Network** > **NET TV** > **OK**.)
- 2 Press **◀** or **▶** to select **YouTube**. Press **OK**.
- 3 Press **▲**, **▼**, **◀** or **▶** to select the file you want to view. Press **OK**.

#### To close YouTube:

Press **EXIT**.

#### Note:

- YouTube contents have been independently managed by YouTube, LLC.
- Not all YouTube contents that can be accessed by computer may be viewed with this TV.
- This TV may not be able to do some operations that computer can do.
- Depending on network environment and the use situation, content may be difficult to view.
- Though the same volume value, an actual volume might be greatly different depending on contents.
- This TV might take time during start-up and the playback of contents.
- Content that the user may feel is improper or offensive may be included in the contents of YouTube.
- We do not assume any responsibility for contents that YouTube offers.
- If you have any questions about YouTube contents, please contact YouTube, LLC.
- The content of service and the screen that can be used may be changed without notice.
- You cannot post videos to YouTube from this TV. Please use a PC to post videos.
- Not all contents can be viewed normally when you access websites other than YouTube Leanback through this TV.

## CinemaNow

CinemaNow is an on-demand service that offers **high definition** movies on the Web.

- 1 Press **NET TV**.  
(From the Menu: **MENU** > **Network** > **NET TV** > **OK**.)
- 2 Press **◀** or **▶** to select **CinemaNow**. Press **OK**.

To close CinemaNow:

Press **EXIT**.

## Blockbuster

Blockbuster is an on-demand service that offers **high definition** movies on the Web.

- 1 Press **NET TV**.  
(From the Menu: **MENU** > **Network** > **NET TV** > **OK**.)
- 2 Press **◀** or **▶** to select **Blockbuster**. Press **OK**.

To close Blockbuster:

Press **EXIT**.

## Pandora

Pandora is an on-demand service that offers music on the Web.

- 1 Press **NET TV**.  
(From the Menu: **MENU** > **Network** > **NET TV** > **OK**.)
- 2 Press **◀** or **▶** to select **Pandora**. Press **OK**.

To close Pandora:

Press **EXIT**.

## Yahoo!® TV Widgets

Yahoo!® TV Widgets provide an integrated Internet and TV experience powered by the Yahoo! Connected TV platform. Yahoo!® TV Widgets allow you to:

- Track your stocks and stay current with financial news.
- Share photos with friends and family.
- Watch your favorite web videos.

- 1 Press **Y!**.  
(From the Menu: **MENU** > **Settings** > **APPLICATIONS** > **Widgets** > **OK**.)

The **Dock** is the horizontal list of snippets appearing at the bottom of your TV screen.



A **snippet** is a shortcut which launches a TV Widget.

- 2 Focus is located in the leftmost region (the highlighted snippet). The dock scrolls snippets under this focal point. Press **◀** or **▶** to focus on a snippet. Press **OK** to select a snippet.
- 3 The TV Widget sidebar appears. Press **▲** or **▼** to select a menu item. Press **OK**.

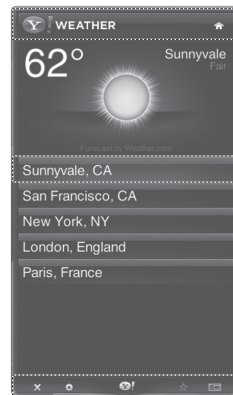

The TV Widget logo and Home button

The currently focused button is highlighted.

The sidebar's bottom toolbar includes four color-coded buttons that map to the colored keys on the remote control.

| Button | Description  |
|--------|--|
| RED    | Closes the widget.   |
| GREEN  | Changes the widget's settings.                               |
| YELLOW | Adds or deletes a snippet.                                   |
| BLUE   | Resizes the video to fit onscreen, or to make it fullscreen. |

### To close Yahoo!® TV Widgets:

Press **EXIT**.

**Note:** To use Yahoo!® TV Widgets you must first complete the "Guided Setup" (see p. 60).

### Using the Profile Widget

- The **Profile Widget** configures your user profile.
- You can set up multiple profiles for multiple users.
- Each profile maintains its own list of TV Widgets.
- The **Switch Profile** menu allows you to switch to a different user profile.
- The **Profile Settings** menu allows you to customize and protect your profile.
- The **System Settings** menu allows you to change your **Location**, **Repeat the Tutorial**, and **Restore Factory Settings**, which deletes all profiles and TV Widget settings (not TV settings).
- The **Administrative Controls** menu allows you to set the **Screen Saver** timeout, create the **Owner PIN**, and to **Create a Profile**.
- The **Sign in to Yahoo!** menu allows you to personalize your experience using your Yahoo! ID.
- Visit <http://www.yahoo.com> to create a Yahoo! ID.

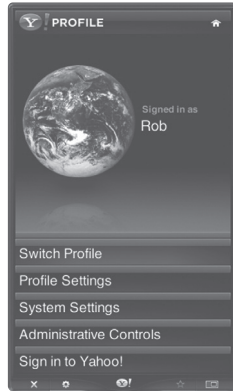

### Using the Widget Gallery

- The **Widget Gallery** allows you to browse and discover new TV Widgets.
- The featured TV Widgets are highlighted in the display case at the top of the sidebar.
- You can also browse available TV Widgets by category.
- To install a widget, select **Add Widget to My Profile** and press **OK**.
- The **Owner PIN** is needed to install widgets for profiles that have been protected through the **Limit Profile** indicator under the **Profile Widget** → **Profile Settings** menu.
- Refer to the **Profile Widget** → **Administrative Controls** menu to set the **Owner PIN**.

### Using other Yahoo! Widgets

- The **Yahoo! News Widget** provides the latest headline news for business, entertainment, politics, sports, top stories, and many other categories.
- The **Yahoo! Weather Widget** provides updates on your local and favorite weather locations.
- View the latest stock news with the **Yahoo! Finance Widget**.
- The **flickr Widget** enables slideshows of family and friends' photos on your TV.

## Using the Media Player

This TV allows you to access photos, movies, and music files stored on a USB device.

Moreover, you can also access photos, movies, and music files from your TV or PC by connecting the TV to your home network.

Term meaning:

DMP: DLNA CERTIFIED™ Player

DMS: DLNA CERTIFIED™ Server

- DMP: The TV can control and play content on a DMS.
  - DMS is a device with server functions that stores media content for playback on a DMP.

**Note:**

- Do not insert/remove USB device while in use.
-  is not available while using the Media Player.

## Media Player Specifications

### Device

USB device:

USB Mass Storage Class devices (MSC)

**Note:**

- Connectivity is not guaranteed for all devices.
- Incorrect behavior may occur with a USB HUB connection.

DLNA CERTIFIED™ Server:

NAS, your PC (for example)

### Supported file system

FAT12, FAT16 and FAT32

You must obtain any required permission from copyright owners to download or use copyrighted content. Toshiba cannot and does not grant such permission.

## Basic operation









### Using Media Player with USB

When Auto Start is enabled, you will be asked if you want to start the Media Player whenever a USB device is inserted. If Auto Start is disabled (or if you want to connect to a DMS on the network), you must manually start the Media Player from the menu.

To change the Auto Start setting:

- 1  > **Settings** > **APPLICATIONS** > **Media Player** > .
- 2 Press  or  to select **Setup**. Press .
- 3 Press  or  to highlight **USB Auto Start**. Press  or  to select **On** or **Off**.

Auto Start:







- 1 Insert a USB device into the USB terminal. A prompt appears.
- 2 Press  or  to select **Yes**. Press .
- 3 Press  or  to select **Photo**, **Movie**, or **Music**. Press . The thumbnail view appears.
- 4 Press  or  to select the USB device if the selection screen appears.

**Note:** If **Auto Start** is set to **Off**, you can start the Media Player manually.

Manual Start:

- 1 Insert a USB device into the USB terminal.
- 2  > **Settings** > **APPLICATIONS** > **Media Player** > .  
(Another:  > **Media Player** > .)
- 3 Press  or  to select **Photo**, **Movie**, or **Music**. Press . The thumbnail appears.
- 4 Press  or  to select the USB device if the selection screen appears.

To select a file in the list of contents:

- 1 Press , , , or  to select a file or folder.
- 2 Press  to move to the next layer, or press  to return to the previous layer.

To close the Media Player:

Press . The TV will return to the last-viewed channel or video input.

## Using Media Player with DLNA CERTIFIED™ Server

You need to configure a home network before using this feature (p. 21).

- 1 > **Settings** > **APPLICATIONS** > **Media Player** > .
- (Another: > **Media Player** > )
- 2 Press or to select **Photo**, **Movie**, or **Music**. Press . The thumbnail (for Photo) or list of files (for Movie and Music) appears.
- 3 Press or to select the server you want to use if a server list is displayed, and press .

### To select a file in the list of contents:

- 1 Press , , , or to select a file or folder.
- 2 Press to move to the next layer, or press to return to the previous layer.

### To close the Media Player:

Press . The TV will return to the last-viewed channel or video input.

## Viewing Movie files

### Basic Playback:

- 1 Select a file ( "To select a file in the list of contents" on p. 64). Press or to begin playback.

**Note:** Depending on the file size, it may take some time to start playback.

- 2 Press to stop playback.
- 3 If playback finishes before is pressed, the screen returns to the list.

**Note:** When the repeat mode is set to **All**, the next file will start playing automatically.

### To pause playback:

Press during playback.

To resume normal playback, press .

**Note:** PAUSE or operations during PAUSE may not be operable depending on the content or DMS.

### To play in fast reverse or fast forward:

Press or during playback. Each time you press or , the playback speed changes.

- : Fast reverse playback
- : Fast forward playback

### To locate a specific file:

Press or repeatedly to access the desired file.

- : Playback starts from the beginning of the previous file.
- : To locate subsequent files.

### Note:

- If the previous or next file is not compatible, it is skipped automatically.
- These features may not be operable depending on the content or DMS.

### To select a language:

If subtitles or audio information is available in the video file, you can select it.

- 1 Press during playback.
- 2 Press or to select **Subtitle** or **Audio**.
- 3 Press or to select your preferred language.

To set the repeat mode:

- 1 Press **QUICK**. The current repeat setting appears.
- 2 Press **◀** or **▶** to select **Off**, **All**, or **1**.
- 3 Press **RETURN**. The setting is effective until the TV is turned off.

| Mode | Description   |
|------|---|
| Off  | The content is played back only once.                   |
| All  | Contents in the same folder are repeatedly played back. |
| 1    | The same content is repeatedly played back.             |

To display the file status information:

- 1 Press **INFO** during playback. The information will be displayed at the bottom of the screen.
- 2 Press **INFO** again to hide the information.

**Note:** The information may not be correctly displayed depending on the content or DMS.



### File specifications:

#### USB use

File format: MPEG2 PS, MPEG2 TS, MP4  
 Video: MPEG2, MPEG4, H.264  
 Audio: MPEG1-Layer2 / MPEG1-Layer3 / AC3 / LPCM

Maximum number of files: 1000 per folder

#### Content on DLNA CERTIFIED™ Server

File format: MPEG2 PS, MPEG2 TS, MP4\*, WMV\*  
 Video: MPEG2(PAL) PAL, MPEG2(TS) PAL, MPEG2(PAL) NTSC, MPEG2(TS) NTSC, H.264\*  
 Audio: LPCM / MPEG1-Layer1 / MPEG1-Layer2 / MPEG2-Layer2 / AC3 / AAC

Maximum number of files: 1000 per folder

\* Some files may not be played.

## Playing Music file

### Basic Playback:

- 1 Select a file (see p. 64). Press **OK** or **▶** to begin playback.  
**Note:** Depending on the file size, it may take some time to start playback.
- 2 Press **■** to stop playback.  
 If playback finishes before **■** is pressed, the next file will start playing automatically.

### To pause playback:

Press **IIII** during playback.  
 To resume normal playback, press **▶**.

**Note:** PAUSE or operations during PAUSE may not be operable depending on the content or DMS.

### To play in fast reverse or fast forward:

Press **◀◀** or **▶▶** during playback. Each time you press **◀◀** or **▶▶**, the playback speed changes.

- **◀◀**: Fast reverse playback
- **▶▶**: Fast forward playback

**Note:** These features may not be operable depending on the content or DMS.

### To locate a specific file:

Press **◀◀◀** or **▶▶▶** repeatedly to access the desired file.

- **◀◀◀**: Playback starts from the beginning of the previous file.
- **▶▶▶**: To locate subsequent files.

**Note:** If the previous or next file is not compatible, it is skipped automatically.

To set the repeat mode:

- 1 Press **QUICK**. The current repeat setting appears.
- 2 Press **◀** or **▶** to select **Off**, **All**, or **1**.
- 3 Press **RETURN**. The setting is effective until the TV is turned off.

| Mode | Description   |
|------|---|
| Off  | Contents in the same folder are played back once.       |
| All  | Contents in the same folder are repeatedly played back. |
| 1    | The same content is repeatedly played back.             |

To display the file status information:

- 1 Press **INFO** during playback. The information will be displayed at the bottom of the screen.
- 2 Press **INFO** again to hide the information.

**Note:** The information may not be correctly displayed depending on the content or DMS.

### File specifications:

#### USB use

File format: MP3, MP4 (AAC), LPCM  
 Sampling frequency: 32 kHz, 44.1 kHz, 48 kHz  
 Bit rate: from 32 to 320 kbps  
 Maximum number of files: 1000 per folder

#### Content on DLNA CERTIFIED™ Server

File format: MP3, LPCM, WMA\*  
 Sampling frequency: 32 kHz, 44.1 kHz, 48 kHz  
 Bit rate: from 32 to 320 kbps  
 Maximum number of files: 1000 per folder

\* Some files may not be played.

## Viewing Photo files

### Multi View mode:

This view mode allows you to search for photos in a grid format. These pictures are displayed using thumbnail data in each image file.

- 1 Press **▲**, **▼**, **◀**, or **▶** to move the highlight by one window.
  - If all of the photos will not fit in one screen, when pressing **◀** at the top left thumbnail, the screen will move to the previous page. Similarly, when pressing **▶** at the bottom right thumbnail, the screen will move to the next page.
- 2 When you select a folder, press **OK** to move to the next layer. Press **RETURN** to move back to the previous layer.
- 3 Press **OK** to view the selected photo in Single View mode.

### Single View mode:

In this view mode, only files located in the selected directory are displayed. When moving from Multi View mode to Single View mode, the currently selected photo is displayed.

- 1 On Multi view mode, press **▲**, **▼**, **◀**, or **▶** to select a file. Press **OK**.
- 2 Press **◀** or **▶** to view the next or previous file.

#### Note:

- If the previous or next file is not compatible, it will be skipped automatically.
- Single view mode is changed to Multi View mode when **RETURN** is pressed.

### Slideshow mode:

This view allows you to watch a slideshow of the photos. In this mode, only files located in the selected directory will be displayed.

- 1 To switch to Slideshow mode, press **OK** while in Single View mode. To return to Single View mode, press **OK** again.
- 2 Press **◀** or **▶** to view the next or previous file.

**Note:** If the previous or next file is not compatible, it is skipped automatically.

### To set the mode settings:

- 1 Press **QUICK** to open the Quick menu while in Single View mode or Slideshow mode.
- 2 Press **▲** or **▼** to select the item (**PICTURE, SOUND, Interval Time, Repeat, Background Music, or Speakers**).
- 3 Press **◀** or **▶** to adjust the setting.
- 4 Press **RETURN** to return to Single View mode or Slideshow mode.

| Item          | Description  |
|---------------|--|
| Interval Time | Sets a time interval to view photos at (3sec, 5sec, 10sec, 15sec, 30sec, 60sec, or 90sec). |
| Repeat        | Displays photos in the same directory repeatedly. On/Off                                   |

### To set the background Music:

- 1 Press **QUICK** to open the Quick menu while in Slideshow mode.
- 2 Press **▲** or **▼** to select **Background Music**. Press **OK**.
- 3 Highlight **Background Music**. Press **◀** or **▶** to select **On**.
- 4 Press **▼** to select **Select Music**. Press **OK**.
- 5 Select a music file.

#### Note:

- The music must be selected from the USB or DMS from which the picture files will be played.
- This feature is not available when there is no music that can be selected.

### To rotate the image:

While viewing the image in Single View mode or Slideshow mode, press **▲** to rotate the image 90 degrees clockwise, press **▼** to rotate the image 90 degrees counterclockwise.

### To return to the thumbnail:

Press **RETURN** while in Single View mode or Slide Show mode.

### To display file status information:

- 1 Press **INFO**. The information will be displayed at the bottom of the screen.
- 2 Press **INFO** again to hide the information.

**Note:** The information may not be correctly displayed depending on the content or DMS.

### File specifications:

#### USB use

Data compatibility: JPEG Exif ver 2.2

File format: JPEG

Maximum viewable resolution:

4096 × 4096 (HW decode)

16384 × 16384 (SW decode)

Maximum photo size: 9 MB

Maximum number of files: 2000 per folder

#### Content on DLNA CERTIFIED™ Server

Data compatibility: JPEG EXIF Ver.1.x or later, JFIF 1.02a

File format: JPEG

Maximum photo resolution: 4096 × 4096

Maximum photo size: 6 MB

Maximum number of files: 2000 per folder



## Using the Wallpaper feature

This feature allows you to display a photo file stored on the TV.

- Only one photo file can be stored on the TV.
- The photo file can be overwritten with a file from an external device (USB, DMS).

1 **MENU** > **Settings** > **PREFERENCES** > **Wallpaper Setup** > **OK**.

(Another: **MENU** > **Wallpaper** > **OK**.)

The preview screen will appear.

2 Press **▶** to select **Start**. Press **OK**.

To close the Wallpaper:

Press **EXIT**.

### Photo Select

1 **MENU** > **Settings** > **PREFERENCES** > **Wallpaper Setup** > **OK**. The preview screen will appear.

2 Press **▲** or **▼** to select **Photo Select**. Press **OK**. The device selection screen appears.

**Note:** This screen will not appear when there is only one device connected.

3 Press **▲** or **▼** to select the appropriate device. Press **OK**.

4 Press **▲**, **▼**, **◀**, or **▶** to select the photo you want to copy from the USB or DMS to the TV. Press **OK**.

### Photo Edit

1 **MENU** > **Settings** > **PREFERENCES** > **Wallpaper Setup** > **OK**. The preview screen appears.

2 Press **▲** or **▼** to select **Photo Edit**. Press **OK**.

3 Press **▲** or **▼** to select **Rotate** or **Delete**.

4 Set the following items as required.

- Rotate - Press **OK** to rotate the image 90° clockwise.
- Delete - Press **OK**. A confirmation screen appears. Select **YES**. Press **OK**.

**Note:** The Factory default image cannot be deleted.

5 Press **EXIT**.

### Auto Power Off

1 **MENU** > **Settings** > **PREFERENCES** > **Wallpaper Setup** > **OK**. The preview screen appears.

2 Press **▲** or **▼** to highlight **Auto Power Off**.

3 Press **◀** or **▶** to select **Off**, **00:30**, **01:00**, **02:00**, **04:00**, **06:00**, or **12:00**.

- If the Wallpaper window is left open, the TV will automatically turn off after the set length of time (maximum 12 hours).

4 Press **EXIT**.

# Chapter 9: Troubleshooting

## General troubleshooting

Before calling a service technician, please check this chapter for a possible cause of the problem and some solutions you can try.

### Black box onscreen

- The closed caption feature is set to one of the Text modes (**T1**, **T2**, **T3**, or **T4**). Set the closed caption feature to **Off** (☞ p. 35).

### TV stops responding to controls

- If the TV stops responding to the remote control or TV control panel and you cannot turn off the TV, press and hold the **POWER** button on the TV control panel for 5 seconds or more to reset the TV.

### Other problems

- If your TV's problem is not addressed in this Troubleshooting section or the recommended solution has not worked, perform the Reset Factory Defaults procedure (☞ p. 44).

### TV will not turn on

- Ensure the power cord is plugged in. Press **POWER** (☞).
- Replace the remote control's batteries.
- Try the control panel buttons.

### Picture problems

#### General picture problems

- Check the antenna/cable connections (☞ 15–21).
- Press **INPUT** on the remote control or the TV and select a valid video input source (☞ p. 34). If no device is connected to an input on the TV, no picture appears when you select that particular input source. Check device connections (☞ 16–21).
- Antenna reception may be poor. Use a highly directional outdoor antenna (if applicable).
- The station may be having broadcast difficulties. Try another channel.
- Adjust the picture quality (☞ p. 48).
- If the Edge Booster does not achieve a sharper picture, change the Sharpness value to **increase the sharpness level** (☞ P. 48).

#### Video Input Selection problems

- If the **Input Selection** window does not appear when you press **INPUT** on the remote control or the TV control panel, press **INPUT** a second time. The TV displays the next video input source and the **Input Selection** screen.

#### Cannot view external signals or channel 3 or 4

- If you cannot view signals from external devices connected to **VIDEO 1**, **VIDEO 2**, **ColorStream HD1**, **ColorStream HD2**, **HDMI 1**, **HDMI 2**, **HDMI 3**, **HDMI 4**, **PC**, or from channel 3 or 4, ensure the **Input Lock** is set to **Off** (☞ p. 38).

#### Poor color or no color

- The station may be having broadcast difficulties. Try another channel.

- Check the Input mode when you use Shared Inputs (☞ p. 30).
- Adjust the **Tint** and/or **Color** (☞ p. 48).

#### Poor composite picture

- If the TV is connected to an external A/V device (e.g. DVD player, video game system, set-top box, etc.) try using a **ColorStream** or **HDMI** video connection instead.

#### Picture and sound are out of sync

- As with all products that contain a digital display, this may occur in rare instances when viewing certain content (e.g. television broadcasts, video games, DVDs). Possible causes may include, without limitation, video processing within the TV, video processing in an attached gaming system, and video processing or different compression rates used by broadcasters in their programming. Try the following procedures:
  - If the TV is connected to an A/V receiver that has a programmable audio delay feature, use this feature to help synchronize the sound to the picture.
  - If the problem occurs only on certain TV channels, inform your local broadcast, cable, or satellite provider.
- The settings of **Side Shared Audio** and **Rear Shared Audio** may be not correct. Ensure the settings (☞ p. 30).

### Sound problems

- Check the antenna/cable connections (☞ 15–20).
- The station may be having broadcast difficulties. Try another channel.
- The sound may be muted. Press **VOLUME**.
- If you hear no sound, try setting the **MTS** feature to **Stereo** mode (☞ p. 52).
- If you are not receiving a second audio program from a known SAP source, make sure the **MTS** feature is set to **SAP** mode (☞ p. 52).
- If you hear audio that seems incorrect for the program you are watching (such as music or a foreign language), the SAP mode may be on. Set the **MTS** feature to **Stereo** mode (☞ p. 52).
- If you connect a PC using either the **PC IN** terminal or an **HDMI** terminal, ensure that the **Rear Shared Audio** setting is properly set (☞ p. 42).

### Remote control problems

- Ensure the remote control is set to the correct device mode (☞ p. 79).
- Remove all obstructions between the remote control and the TV.
- Replace the remote control's batteries (☞ p. 22).
- Your TV's remote control may not operate certain features on your external device. Refer to the owner's manual for your other device to determine its available features. If your TV remote control does not operate a specific feature on another device, use the remote control that came with the device (☞ p. 82–87).
- If the TV still does not act as expected, perform the Reset Factory Defaults procedure (☞ p. 44).

### Channel tuning problems

- Ensure the remote control is set to the correct device mode (☞ p. 79).
- The **Auto Tuning** feature may have erased the channel from memory. Add the channel to the channel memory (☞ p. 28).
- The **Lock** feature may have blocked the channel. Unblock the channel (☞ p. 38).
- If you cannot tune digital channels, check the antenna configuration (☞ p. 28). If the problem persists, clear all channels from the channel list and reprogram channels into memory (☞ p. 28). If the problem persists, use the Reset Factory Defaults procedure (☞ p. 44). See “TV stops responding to controls” and “Other problems” (☞ p. 70).

### Closed caption problems

- If the program or video you have selected is not closed-captioned, no captions appear.
- If text is not available, a black rectangle may appear. If this happens, turn off the closed-caption feature (☞ p. 35).
- A closed-caption signal may not display correctly under the following circumstances: a) the videotape is dubbed; b) the signal reception is weak; or c) the signal reception is nonstandard (☞ p. 35).

### Rating blocking (V-Chip) problems

- If you forget your PIN code: While the PIN code entering screen is displayed, press **INFO** 4 times within 5 seconds. The old PIN code is cleared (☞ p. 36).
- The V-Chip feature is available for U.S. V-Chip systems only (☞ p. 36).

### No HDMI® CEC Control operation

- HDMI® CEC Control feature is available for Toshiba HDMI® CEC compatible devices.
- Ensure HDMI cables with the HDMI Logo (**HDMI**) are used.
- When the connected HDMI® CEC device does not work correctly after you have changed the device's settings, turn off your TV and unplug the power cord, then plug it in and turn it on again.
- If several devices are connected, HDMI® CEC Control feature may not operate properly.
- Read the instruction manual of the connected HDMI® CEC device.

### HDMI problems

#### For HDMI cables

- Ensure HDMI cables with the HDMI Logo (**HDMI**) are used (☞ p. 14).

#### For Legacy HDMI sources

- Some legacy HDMI sources may not work properly with the latest HDMI TV products due to new standards. Turn off INSTAPORT™ (☞ p. 41).

### Network problems

#### Cannot connect to the Internet

- Check the modem and its incoming cable/telephone connections (☞ p. 21).
- Confirm your modem's operation.
- Ensure your IP address is set up correctly.

#### No network connection

- If using a wired network connection, check to ensure the LAN cables are connected properly (☞ p. 21).
- Ensure the modem and router power cords are plugged in and the devices are operating properly.
- Ensure your IP address is set up correctly. See Section (☞ “Setting up the Network”).
- Check to ensure proper operation of other network connected devices.

#### Network Setup fails (Auto)

- Check to ensure the LAN cables are connected properly (☞ p. 21).
- DHCP is not enabled on the router, or no router is present. Refer to your router's documentation for instructions on enabling DHCP. If your router does not support DHCP, you must manually set up the IP address.
- Internet service is not available. Check your cable/DSL modem or contact your ISP for Internet service issues.

#### Network Setup fails (Manual)

- Ensure the TV IP address is not the same as any other device on the network.  
Example: IP address 192.168.0.100 and IP address 192.168.0.101 are different addresses on the same network.
- Make sure the TV IP address is on the same subnet as the networked PC.

Example of proper setup: The PC has the IP address 192.168.0.100 with the Subnet mask 255.255.255.0, the TV has the IP address 192.168.0.101 with the Subnet mask 255.255.255.0; both are on the same subnet.

Example of improper setup: The PC has the IP address 192.168.1.100 with the Subnet mask 255.255.255.0, the TV has the IP address 192.168.0.101 with the Subnet mask 255.255.253.0; they are on different sub-nets.

#### Unstable network connection

- When using a wired home-network connection, unplug the LAN cables, and then reconnect them.
- When using a wireless home-network connection:
  - Remove AC power from the router and the television for 30 seconds.
    - Reconnect AC power to the router.
    - Reconnect AC power to the television and turn it ON. After 2 minutes, check connection stability.
  - Connect with LAN cables, if possible, and check connection stability.
  - Repeat the wireless network setup procedure and check connection stability.

#### The DMS name is not displayed

- The LAN cables, if used, are not connected properly (☞ p. 21).
- The WLAN, if used, is not configured properly.
- The network setup on the Server is incorrect. Make sure both the DMS and TV are using the same network type (DHCP/manual) and have compatible network settings.

(continued)

- Too many DMSs are connected. You cannot connect more than 32 sharing devices at one time.
- The DMS is not turned ON.
- The “server” is not a DMS device.
- Check the firewall and streaming settings on the DMS.

### Wireless network problems

- Check that the router/AP (Access point) power is ON.
- After starting wireless network setup, confirm that the network is configured properly by performing the network connection test (☞ p. 59).
- Check the router/AP’s connection status (☞ p. 57).
- If the router/AP does not support PBC or WPS, Easy Setup (PBC) will not work even if the push-button is pressed.
- If the available router/AP list is not displayed in Easy Setup (PBC) or Assisted Setup, the power of the router/AP may be OFF. Check that it is ON, and then try re-starting the scan for available routers/APs.
- Refer to the router/AP’s instruction manual.

### NET TV or Widget problems

- If the date and time display on the NET TV menu is wrong, turn off the TV, and turn it on again.
- NET TV or Widgets may not be immediately available after turning the TV on while the system is booting.
- Content delivered by NET TV or Widgets are the responsibility of the Content Service Provider. Contact the Service Provider to discuss any content issues.

### Media Player problems

- Ensure that the devices (Display and Server) are connected correctly.
- Incorrect behavior may occur when using a USB HUB connection.
- Photo files that were processed and edited using the PC’s application software may not be viewable.
- When viewing content that supports two or more formats the display may select one format automatically.
- Copyright protected content stored on the DMS may not be playable on the display.
- Content playback stability may be affected by heavy network traffic.
- Content originally recorded on a PC may not play correctly.
- Set the media sharing of the DMS correctly, according to the DMS instruction manual.
- Confirm that the contents of either the DMS or the USB storage device are in formats that are supported by this TV (☞ p. 66, 67, or 68).
- Depending on the DMS, access may be limited by the MAC address. Set the server according to the DMS’s instruction manual. This TV’s MAC Address can be confirmed in the Network Setup portion of the User Menu (☞ p. 58).

#### For DLNA CERTIFIED™ Player

- Depending on the DMS, it may take time to display the list.

## LED indications

The POWER and service LED lights on the front of the TV indicate the TV’s status, as described below.

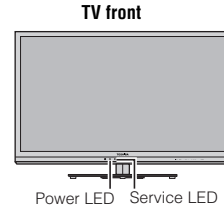

### POWER On/Standby LED

- **Green**  
The TV is operating properly.
- **RED**  
The TV is on standby.
- **Green blinks**  
System booting. After a while, the screen appears.
- **Red blinks**  
Power-On Failure. Turn off the TV and unplug the power cord. Then plug the power cord in again and turn on the TV.

### Service LED

- **Green**  
Software is being upgraded.
- **Green blinks (if applicable)**  
Abnormal operation of BUS line. Turn off the TV and unplug the power cord. Then plug the power cord in again and turn on the TV.

If the problem persists after trying the solutions:

- In the U.S., visit TAIS Consumer Solutions on the web at [www.support.toshiba.com](http://www.support.toshiba.com) or call 1-800-631-3811.
- In Canada, locate the nearest Toshiba authorized service depot by directing your web browser to [www.toshiba.ca](http://www.toshiba.ca); click “Home Entertainment,” and then click “Support.”

# Chapter 10: Appendix

## Specifications

### Note:

- *This model complies with the specifications listed below.*
- *Designs and specifications are subject to change without notice.*
- *This model may not be compatible with features and/or specifications that may be added in the future.*

### Television System

NTSC standard  
ATSC standard (8VSB)  
Digital Cable (64 QAM, 256 QAM; in-the-clear, unencrypted)

### Channel Coverage

VHF: 2 through 13  
UHF: 14 through 69  
Cable TV: Mid band (A-8 through A-1, A through I)  
Super band (J through W)  
Hyper band (AA through ZZ, AAA, BBB)  
Ultra band (65 through 94, 100 through 135)

### Power Source

120 V AC, 60 Hz

### Power Consumption

42SL417U: 1.1 A (rms) (maximum current)  
0.4 W in standby mode  
46SL417U: 1.2 A (rms) (maximum current)  
0.4 W in standby mode  
55SL417U: 1.4 A (rms) (maximum current)  
0.4 W in standby mode

### Audio Power

Main: 10 W + 10 W

### Speaker Type

Main: Four 13/16 × 2-9/16 inches (20 × 65 mm)

### Video/Audio Terminals

#### VIDEO/AUDIO INPUT:

VIDEO: 1 V(p-p), 75 ohm, negative sync.  
AUDIO: 200 mV(rms) (-20dBFS)

#### ColorStream® (component video) HD INPUT:

VIDEO: Y: 1V(p-p), 75 ohm  
Pr: 0.7 V(p-p), 75 ohm  
Pb: 0.7 V(p-p), 75 ohm  
Suggested formats: 1080p, 1080i, 720p, 480p, 480i  
AUDIO: 200 mV(rms), 22 k ohm or greater

#### HDMI® INPUT:

HDMI compliant  
HDCP compliant  
Suggested formats: See table on p. 76.  
HDMI Audio: 2-channel Linear-PCM/AC-3; 32/44.1/48 kHz sampling frequency; 16/20/24 bits per sample

#### DIGITAL AUDIO OUTPUT:

Optical type

#### PC INPUT:

15-Pin D-sub Analog RGB

### Wireless connection

- Standard: IEEE 802.11a/b/g/n
- Host Interface: USB2.0 compatible
- Frequency Range: 5.15–5.35 GHz, 5.47–5.725 GHz, 5.725–5.850 GHz, 2.412–2.462 GHz
- Security: WEP64/128, TKIP, AES, WPA/WPA2-PSK, WPS, None

### Ethernet

- IEEE 802.3.

### USB

- Universal Serial Bus Specification, Revision 1.1.
- Universal Serial Bus Specification, Revision 2.0.

### Dimensions (include foot stand)

42SL417U: Width: 38-15/16 inches (989 mm)  
Height: 26-19/32 inches (675 mm)  
Depth: 11-5/16 inches (287 mm)  
46SL417U: Width: 42-15/32 inches (1,078 mm)  
Height: 28-19/32 inches (726 mm)  
Depth: 11-5/16 inches (287 mm)  
55SL417U: Width: 49-13/16 inches (1,265 mm)  
Height: 33-3/32 inches (8400 mm)  
Depth: 14-7/32 inches (361 mm)

### Mass (weight)

42SL417U: 45.2 lbs (20.5 kg)  
46SL417U: 49.7 lbs (22.5 kg)  
55SL417U: 67.3 lbs (30.5 kg)

### Operating conditions

Temperature: 32°F - 95°F (0°C - 35°C)  
Humidity: 20 - 80% (no moisture condensation)

**Supplied Accessories**

- Easy Setup Guide
- Pedestal assembly installation manual
- Stop/Quick set up guide
- Remote control with two “AA” size batteries
- Mounting screw  
Use this screw to secure the TV. See item 26 on p. 4.
- Securement Clip  
Use this clip to attach the TV to a wall stud, pillar, or other immovable structure. See item 26 on p. 4 and instructions on p. 5.
- Tool set
- Four Spacers  
Use these to attach a wall bracket. See p. 5.
- Two Cable clamps
- Two AV adapter cables
- Component adapter cable

## Acceptable signal formats for PC IN and HDMI terminals

### PC IN signal formats

**Note:**

- The PC IN on this TV only accepts signal formats which are compliant with VESA-DMT as in the table below. Since some PC input signals are different from the resolution and frequency described in the table below, the following problems may occur: incorrect display, false format detection, picture position failure, blur, or judder. In these cases, set the monitor output format on your PC to conform to any of the signals in the table below.
- The signals whose vertical frequency is 56 Hz, 70 Hz, 72 Hz, or 75 Hz are converted to a 60 Hz signal.
- When you connect a PC to this TV, it is recommended to set the refresh rate of your PC to 60 Hz.
- The PC IN on this TV does not accept the Sync on Green, Composite Sync, and Interlace signals.

| Format | Resolution  | V. Frequency | H. Frequency      | Pixel Clock Frequency | VESA Standard (DMT) |
|--------|-------------|--------------|-------------------|-----------------------|---------------------|
| VGA    | 640 × 480   | 59.940/60 Hz | 31.469/31.500 kHz | 25.175/25.200 MHz     | ●                   |
|        |             | 72.809 Hz    | 37.861 kHz        | 31.500 MHz            | ●                   |
|        |             | 75.000 Hz    | 37.500 kHz        | 31.500 MHz            | ●                   |
| SVGA   | 800 × 600   | 56.250 Hz    | 35.156 kHz        | 36.000 MHz            | ●                   |
|        |             | 60.317 Hz    | 37.879 kHz        | 40.000 MHz            | ●                   |
|        |             | 72.188 Hz    | 48.077 kHz        | 50.000 MHz            | ●                   |
|        |             | 75.000 Hz    | 46.875 kHz        | 49.500 MHz            | ●                   |
| XGA    | 1024 × 768  | 60.004 Hz    | 48.363 kHz        | 65.000 MHz            | ●                   |
|        |             | 70.069 Hz    | 56.476 kHz        | 75.000 MHz            | ●                   |
|        |             | 75.029 Hz    | 60.023 kHz        | 78.750 MHz            | ●                   |
| WXGA   | 1280 × 768  | 59.995 Hz    | 47.396 kHz        | 68.250 MHz            | ●                   |
|        |             | 59.870 Hz    | 47.776 kHz        | 79.500 MHz            | ●                   |
|        |             | 74.893 Hz    | 60.289 kHz        | 102.250 MHz           | ●                   |
|        | 1360 × 768  | 60.015 Hz    | 47.712 kHz        | 85.500 MHz            | ●                   |
| SXGA   | 1280 × 1024 | 60.020 Hz    | 63.981 kHz        | 108.000 MHz           | ●                   |
|        |             | 75.025 Hz    | 79.976 kHz        | 135.000 MHz           | ●                   |

## HDMI signal formats

**Note:**

- The HDMI inputs on this TV only accept VGA, SVGA, XGA, WXGA, and SXGA signal formats which are compliant with VESA-DMT as in the table below. Since some PC, HDMI, or DVI device input signals are different from the resolution and frequency described in the table below, the following problems may occur: incorrect display, false format detection, picture position failure, blur, or judder. In these cases, set the monitor output format on your PC, HDMI, or DVI device to conform to any of the signals in the table below.
- The signals whose vertical frequency is 24 Hz, 56 Hz, 70 Hz, 72 Hz, or 75 Hz are converted to a 60 Hz signal.
- When you connect a PC to this TV, it is recommended to set the refresh rate of your PC to 60 Hz.

| Format | Resolution   | V. Frequency | H. Frequency      | Pixel Clock Frequency | VESA Standard |
|--------|--------------|--------------|-------------------|-----------------------|---------------|
| VGA    | 640 × 480    | 59.940 Hz    | 31.469 kHz        | 25.175 MHz            | ●             |
|        |              | 72.809 Hz    | 37.861 kHz        | 31.500 MHz            | ●             |
|        |              | 75.000 Hz    | 37.500 kHz        | 31.500 MHz            | ●             |
| SVGA   | 800 × 600    | 56.250 Hz    | 35.156 kHz        | 36.000 MHz            | ●             |
|        |              | 60.317 Hz    | 37.879 kHz        | 40.000 MHz            | ●             |
|        |              | 72.188 Hz    | 48.077 kHz        | 50.000 MHz            | ●             |
|        |              | 75.000 Hz    | 46.875 kHz        | 49.500 MHz            | ●             |
| XGA    | 1024 × 768   | 60.004 Hz    | 48.363 kHz        | 65.000 MHz            | ●             |
|        |              | 70.069 Hz    | 56.476 kHz        | 75.000 MHz            | ●             |
|        |              | 75.029 Hz    | 60.023 kHz        | 78.750 MHz            | ●             |
| WXGA   | 1280 × 768   | 59.995 Hz    | 47.396 kHz        | 68.250 MHz            | ●             |
|        |              | 59.870 Hz    | 47.776 kHz        | 79.500 MHz            | ●             |
|        |              | 74.893 Hz    | 60.289 kHz        | 102.250 MHz           | ●             |
|        | 1360 × 768   | 60.015 Hz    | 47.712 kHz        | 85.500 MHz            | ●             |
| SXGA   | 1280 × 1024  | 60.020 Hz    | 63.981 kHz        | 108.000 MHz           | ●             |
|        |              | 75.000 Hz    | 79.976 kHz        | 135.000 MHz           | ●             |
| 480i   | 720 × 480i   | 59.940/60 Hz | 15.734/15.750 kHz | 27.000/27.027 MHz     |               |
| 480p   | 720 × 480p   | 59.940/60 Hz | 31.469/31.500 kHz | 27.000/27.027 MHz     |               |
| 720p   | 1280 × 720p  | 59.940/60 Hz | 44.955/45.000 kHz | 74.176/74.250 MHz     |               |
| 1080i  | 1920 × 1080i | 59.940/60 Hz | 33.716/33.750 kHz | 74.176/74.250 MHz     |               |
| 1080p  | 1920 × 1080p | 23.976/24 Hz | 26.973/27.000 kHz | 74.176/74.250 MHz     |               |
|        |              | 59.940/60 Hz | 67.433/67.500 kHz | 148.352/148.500 MHz   |               |



## Remote control functional key chart

| REMOTE CONTROL KEY  | Toshiba TV                           | CABLE             | SAT (satellite)   | Blu-ray™          | DVD/DVD-R         | VCR               | Reciver/Amp     | CD             |
|---------------------|--------------------------------------|-------------------|-------------------|-------------------|-------------------|-------------------|-----------------|----------------|
| GAME                | Game                                 | ---               | ---               | ---               | ---               | ---               | ---             | ---            |
| POWER               | Power                                | Power             | Power             | Power             | Power             | Power             | Power           | Power          |
| FREEZE              | (TV) Freeze                          |                   |                   |                   |                   |                   |                 |                |
| MODE SELECT         | Remote control device mode selection |                   |                   |                   |                   |                   |                 |                |
| 1                   | 1                                    | 1                 | 1                 | 1                 | 1                 | 1                 | AV input 1      | 1              |
| 2                   | 2                                    | 2                 | 2                 | 2                 | 2                 | 2                 | AV input 2      | 2              |
| 3                   | 3                                    | 3                 | 3                 | 3                 | 3                 | 3                 | AV input 3      | 3              |
| 4                   | 4                                    | 4                 | 4                 | 4                 | 4                 | 4                 | AV input 4      | 4              |
| 5                   | 5                                    | 5                 | 5                 | 5                 | 5                 | 5                 | CD              | 5              |
| 6                   | 6                                    | 6                 | 6                 | 6                 | 6                 | 6                 | Tuner           | 6              |
| 7                   | 7                                    | 7                 | 7                 | 7                 | 7                 | 7                 | Phono           | 7              |
| 8                   | 8                                    | 8                 | 8                 | 8                 | 8                 | 8                 | Cassette        | 8              |
| 9                   | 9                                    | 9                 | 9                 | 9                 | 9                 | 9                 | AUX             | 9              |
| 0                   | 0                                    | 0                 | 0                 | 0                 | 0                 | 0                 | ---             | 0              |
| -                   | – (digital separator)                | ---               | +10               | +10               | +10               | +100              | ---             | ---            |
| INPUT               | (TV) Input                           |                   |                   |                   |                   |                   | Input           | Input          |
| VOL +/-             | Volume up/down                       | Volume up/down *1 | Volume up/down *1 | Volume up/down *1 | Volume up/down *1 | Volume up/down *1 | Volume up/down  | Volume up/down |
| QUICK               | Quick Menu                           | ---               | ---               | ---               | ---               | ---               | ---             | ---            |
| MUTE                | Mute                                 | Mute*1            | Mute*1            | Mute*1            | Mute*1            | Mute*1            | Mute            | Mute           |
| CH RTN              | Last channel                         | Last channel      | Last channel      | ---               | ---               | ---               | ---             | ---            |
| CH▲▼                | Channel up/down                      | Channel up/down   | Channel up/down   | ---               | Channel up/down   | Channel up/down   | Channel up/down | ---            |
| NET TV / POPUP MENU | NET TV                               | ---               | ---               | Popup Menu        | Menu              | ---               | ---             | ---            |
| NETFLIX             | Netflix                              | ---               | ---               | ---               | ---               | ---               | ---             | ---            |
| Y! WIDGETS          | Yahoo! TV Widgets                    | ---               | ---               | ---               | ---               | ---               | ---             | ---            |
| INFO                | (TV) Info                            |                   |                   |                   |                   |                   |                 |                |
| ⏴ / ⏵               | Page up/down                         | ---               | ---               | ---               | ---               | ---               | ---             | ---            |
| ⏴ ⏴                 | Page left/Channel Browser            | ---               | ---               | ---               | ---               | ---               | ---             | ---            |

## Chapter 10: Appendix

| REMOTE CONTROL KEY  | Toshiba TV                         | CABLE                  | SAT (satellite)         | Blu-ray™             | DVD/DVD-R                      | VCR                         | Reciver/Amp | CD              |
|---|------------------------------------|------------------------|-------------------------|----------------------|--------------------------------|-----------------------------|-------------|-----------------|
| »  | Page right/<br>Favorite<br>Browser | ---                    | ---                     | ---                  | ---                            | ---                         | ---         | ---             |
| MENU  | Menu                               | Menu,<br>Cable<br>Menu | Menu,<br>Action<br>Menu | Top<br>Menu          | Top<br>Menu                    | ---                         | Menu        | Menu            |
| GUIDE   | Guide                              | Guide                  | Guide                   | ---                  | ---                            | ---                         | ---         | ---             |
| RETURN  | Return                             | ---                    | ---                     | Return               | Return                         | ---                         | ---         | ---             |
| EXIT  | Exit                               | Exit                   | Exit                    | Clear                | Clear                          | ---                         | ---         | ---             |
| ▲ / ▼   | Menu select<br>up/down             | Cursor<br>up/down      | Cursor<br>up/down       | Cursor<br>up/down    | Cursor<br>up/down              | ---                         | ---         | ---             |
| ◀ / ▶   | Menu select<br>left/right          | Cursor<br>left/right   | Cursor<br>left/right    | Cursor<br>left/right | Cursor<br>left/right           | ---                         | ---         | ---             |
| OK  | OK                                 | Select                 | Select                  | Select               | Select                         | ---                         | ---         | ---             |
| REW   | Rewind*2                           | Rewind                 | Rewind                  | Rewind               | Rewind                         | Rewind                      | ---         | Rewind          |
| PLAY  | Play*2                             | Play                   | Play                    | Play                 | Play                           | Play                        | ---         | Play            |
| FF  | Fast<br>Forward*2                  | Fast<br>Forward        | Fast<br>Forward         | Fast<br>Forward      | Fast<br>Forward                | Fast<br>Forward             | ---         | Fast<br>Forward |
| SKIP ◀◀   | Skip REW/<br>DAY- *2               | ---                    | ---                     | Skip<br>REW          | Skip<br>REW                    | ---                         | ---         | Skip<br>REW     |
| STOP  | Stop*2                             | Stop                   | Stop                    | Stop                 | Stop                           | Stop                        | ---         | Stop            |
| PAUSE/<br>STEP  | Pause*2                            | Pause                  | Pause                   | Pause                | Pause                          | Pause                       | ---         | Pause           |
| SKIP ▶▶   | Skip FWD/<br>DAY+ *2               | ---                    | ---                     | Skip<br>FWD          | Skip<br>FWD                    | ---                         | ---         | Skip<br>FWD     |
| RED   | Red                                | ---                    | ---                     | Red                  | Red                            | ---                         | ---         | ---             |
| GREEN   | Green                              | ---                    | ---                     | Green                | Green                          | ---                         | ---         | ---             |
| YELLOW  | Yellow                             | ---                    | ---                     | Yellow               | Yellow                         | ---                         | ---         | ---             |
| BLUE/<br>HOME   | Blue/Home                          | ---                    | ---                     | Blue                 | Blue                           | ---                         | ---         | ---             |
| SLEEP   | (TV)Sleep                          |                        |                         |                      |                                |                             |             |                 |
| PIC SIZE  | (TV) Picture size                  |                        |                         |                      |                                |                             |             |                 |
| MTS/AUDIO   | MTS                                | ---                    | ---                     | Audio                | Audio                          | ---                         | ---         | ---             |
| CC/<br>SUBTITLE   | C. Caption                         | ---                    | ---                     | Subtitle             | Subtitle                       | ---                         | ---         | ---             |
| SET UP  | --                                 | ---                    | ---                     | Setup                | Setup                          | ---                         | ---         | ---             |
| REC   | Record                             | Record                 | Record                  | ---                  | Record *3<br>(Double<br>click) | Record<br>(Double<br>click) | ---         | ---             |

**Note:**

- “---” = key does not send a signal in that remote control mode.

\*1 Volume affects the TV by default. When the volume is unlocked, each device has its own volume if its ID has volume data. The AUDIO modes will have their own volume if volume lock is set on TV, CABLE/SAT, VCR/PVR, or DVD mode. See “Locking the volume keys” (p. 80).

\*2 This function is available for only HDMI® CEC (p. 40) and Media Player.

\*3 DVD: REC is only for DVD Recorder, no function is selected for DVD Player.

## Operating other devices

Your TV remote control has one dedicated TV mode and three programmable multi-brand modes: **CABLE/SAT**, **BD/DVD**, and **AUX**.

**Note:** To operate a non-Toshiba device or a Toshiba device that the remote control is not preprogrammed to operate, you must program the remote.

| Mode select | Default device mode control (before programming) |
|-------------|--|
| TV          | Toshiba TV                                       |
| CABLE/SAT   | Toshiba Satellite receiver                       |
| BD/DVD      | Toshiba Blu-ray Disc™ player                     |
| AUX         | Onkyo Receiver                                   |

| Mode select | Device mode control (after programming) |
|-------------|---|
| TV          | Toshiba TV                              |
| CABLE/SAT   | Multi-brand video/audio devices         |
| BD/DVD      |   |
| AUX         |   |

**Note:** If you cannot program the TV's remote to operate your device or some of its features, use the device's remote or the controls on the device.

## Programming the remote to operate other devices

### Device code setup

- 1 Find the code for your device brand in the remote control device code table (p. 82–87). If multiple codes are listed, try each one separately until you find one that works.
- 2 Press a mode select button (**CABLE/SAT**, **BD/DVD**, or **AUX**).
- 3 While holding down **INFO**, input the 4-digit code for your device.
- 4 Point the remote at the device. Press **POWER** to test the code.

| Result                       | Meaning  |
|------------------------------|--|
| The device responds.         | Valid code   |
| The device does not respond. | Invalid code<br>Repeat the procedure, using another code |

- 5 When programming is complete, test all necessary keys on the TV's remote that operate your device. If some keys are not operational, repeat the device code setup using another code (if other codes are listed for your device).
- 6 To control the TV, press TV.
- 7 If your VCR does not respond to the codes for your VCR brand, and has a switch labeled VCR1/VCR2, set the switch to the other position, then program the remote control.

**Note:** Every time you change the batteries, you must reprogram the remote.

## Searching for a device code

If you do not know the device code for a particular device, you can view each available code for that device mode and sample the functions to find the code that operates the target device.

- 1 Press a mode select button on the remote.
- 2 While holding down **INFO**, press **8, 5, 0, 0**. The remote control enters program mode.
- 3 Point the remote at the target device. Press **POWER**, **1**, **+VOL**, **CH**, or **▶**, and then press **▲** or **▼** to change a code.
- 4 If the device responds to the remote control: Press **INFO** to store the device code. The remote exits program mode.
- 5 If the device does not respond to the remote control: Repeat this step until the device responds to the remote.  
When no code is found, exit the program mode by the following operation:
  - Press **INFO**. (current state is stored)
  - Press no key for 10 seconds. (current state is not stored)

**Note:** When a search cycle is completed, the remote displays each available code again. If no key is pressed within 10 seconds, the remote exits program mode and returns to the previous code.

## Locking the volume keys

The remote's volume keys (**+VOL**, **-VOL**, and **MUTE**) are locked to a device mode.

| State                            | Meaning   |
|----------------------------------|---|
| Locked (default)                 | The remote operates the TV's volume except the AUX mode, even when the TV is not the current device mode.   |
| Unlocked                         | The remote operates the volume of the device associated with the current device mode.<br>Each device mode has its own volume (if the device ID has volume data).  |
| Locked to a specific device mode | The remote operates the volume of the device associated with the locked mode, even when the locked mode is not the current device mode.<br><b>Note:</b> The AUX mode is not locked to other device modes. |

See "Operating other devices" (p. 79).

To lock the remote's volume keys to a specific mode:  
Example: CABLE/SAT mode

- 1 Press CABLE/SAT.
- 2 While holding down **INFO**, press **8, 0, 0, 0**.
- 3 Press **+VOL** (locked).  
The remote's volume keys now operate the volume of the device associated with the CABLE/SAT mode, even when CABLE/SAT is not the current device mode.

To unlock the remote's volume keys:

- 1 While holding down **INFO**, press **8, 0, 0, 0**.
- 2 Press **-VOL**. The CABLE/SAT mode is unlocked.

## Clearing the remote's programming

You can clear all programmed remote control features not related to "Device code setup" and reset the volume lock to the TV device mode.

While holding down **INFO**, press **8, 9, 0, 0**.

## Resetting to the factory default

You can clear changed manufacturing features.

While holding down **INFO**, press **8, 9, 0, 1**.

## Operating the TV with combination buttons

You can directly operate the TV power, input switch, picture size switch, and picture mode switch by pressing a combination button while holding down a color button.

| Color button | Combination button        | Behavior/Mode                |
|--------------|---------------------------|------------------------------|
| RED          | GAME                      | Power Off                    |
|              | POWER                     | Power On                     |
|              | 1                         | Video 1                      |
|              | 2                         | Video 2                      |
|              | 3                         | ColorStream HD1              |
|              | 4                         | ColorStream HD2              |
|              | 5                         | HDMI 1                       |
|              | 6                         | HDMI 2                       |
|              | 7                         | HDMI 3                       |
|              | 8                         | HDMI 4                       |
|              | 9                         | PC                           |
| GREEN        | 0                         | ANT/CABLE                    |
|              | MUTE                      | Mute On                      |
|              | 1                         | Native (Picture Size)        |
|              | 2                         | 4:3 (Picture Size)           |
|              | 3                         | TheaterWide 1 (Picture Size) |
|              | 4                         | TheaterWide 2 (Picture Size) |
|              | 5                         | TheaterWide 3 (Picture Size) |
|              | 6                         | Full (Picture Size)          |
|              | 7                         | Normal (Picture Size)        |
| 8            | Dot by Dot (Picture Size) |                              |
| YELLOW       | MUTE                      | 1/2 Mute On                  |
|              | 1                         | AutoView (Picture Mode)      |
|              | 2                         | Sports (Picture Mode)        |
|              | 3                         | Standard (Picture Mode)      |
|              | 4                         | Movie 1 (Picture Mode)       |
|              | 5                         | Movie 2 (Picture Mode)       |
|              | 6                         | Store (Picture Mode)         |
|              | 7                         | Game (Picture Mode)          |
|              | 8                         | PC (Picture Mode)            |
| MUTE         | Mute Off                  |                              |

## Remote control codes

In some cases, you may not be able to operate your device with the TV remote control. Your device may use a code that is not recognized by the TV remote control. If this happens, use the device's remote control.

### Satellite

| Brand                   | Code   |
|-------------------------|--|
| BELL EXPRESSVU          | 0009, 0087   |
| CHAPPARAL               | 0112   |
| COOLSAT                 | 0015, 0109   |
| DIGIWAV                 | 0019   |
| DIRECTV                 | 0020, 0027, 0013, 0018, 0028, 0028, 0027, 0029, 0030, 0090, 0091, 0105, 0107, 0108, 0118, 0119 |
| DISH NETWORK            | 0009   |
| DRAKE                   | 0025, 0094, 0095   |
| ECHOSTAR                | 0009, 0008, 0010, 0011, 0012   |
| EXPRESSVU               | 0087   |
| FORTEC STAR             | 0016, 0093, 0104, 0113   |
| GE                      | 0092   |
| GENERAL INSTRUMENT (GI) | 0017, 0103   |
| GLOBECAT                | 0097, 0098   |
| HITACHI                 | 0020, 0105, 0107, 0108   |
| HUGHES NETWORK          | 0020, 0115, 0116   |
| LG                      | 0020   |
| MAGNAVOX                | 0027, 0089   |
| MITSUBISHI              | 0020, 0105, 0107, 0108   |
| MOTOROLA                | 0017, 0024, 0103   |
| NEOSAT                  | 0009   |
| NOVAPLEX                | 0101   |
| NET                     | 0026   |
| PACE                    | 0023, 0024   |
| PANASONIC               | 0013, 0014, 0016   |
| PANSAT                  | 0016   |

|                  |  |
|------------------|--|
| PHILIPS          | 0027, 0020, 0089, 0105, 0107, 0108, 0116   |
| PHILIPS-MAGNAVOX | 0027, 0089   |
| PRIMESTAR        | 0017   |
| SAMSONIC         | 0114   |
| SAMSUNG          | 0018   |
| SKY NETWORK      | 0023, 0024, 0027, 0090, 0091   |
| SONY             | 0028, 0117   |
| STAR SIGHT       | 0088   |
| STARCHOICE       | 0017   |
| STS              | 0111   |
| SUPER GUIDE      | 0110   |
| SYLVANIA         | 0102   |
| THOMSON          | 0027   |
| TOSHIBA          | 0020, 0022, 0000, 0001, 0002, 0003, 0004, 0005, 0006, 0007, 0096, 0099, 0105, 0107, 0108 |
| ULTIMATE TV      | 0028   |
| UNIDEN           | 0088   |
| VIDEO CIPHER     | 0025   |
| VISIONTEC        | 0106   |
| VIEWSAT          | 0021   |
| ZENITH           | 0024, 0025, 0094, 0095, 0100   |

### Cable

| Brand       | Code                         |
|-------------|------------------------------|
| ABC         | 0081, 0078, 0065, 0079, 0123 |
| ADELPHIA    | 0045                         |
| ALLEGRO     | 0039, 0059                   |
| AMERICAST   | 0052                         |
| ANTRONIX    | 0033, 0077, 0124             |
| ARCHER      | 0033, 0077, 0082, 0124       |
| AT&T        | 0068                         |
| BELL        | 0069                         |
| BELL SOUTH  | 0052                         |
| CABLETENNA  | 0033                         |
| CABLEVIEW   | 0033                         |
| CABLEVISION | 0045                         |
| CENTURY     | 0082                         |
| CHARTER     | 0045                         |
| CITIZEN     | 0082                         |
| CLEARMAX    | 0042                         |
| COLOR VOICE | 0040                         |

|                         |  |
|-------------------------|--|
| COMCAST                 | 0045, 0073, 0121                               |
| COMTRONICS              | 0036, 0083, 0122                               |
| CONTEC                  | 0064   |
| DIGITAL MUSIC EXPRESS   | 0046   |
| EASTERN                 | 0061   |
| EVERQUEST               | 0036   |
| GARRARD                 | 0082   |
| GC ELECTRONICS          | 0077, 0124                                     |
| GE                      | 0038   |
| GEMINI                  | 0074, 0031                                     |
| GENERAL INSTRUMENT (GI) | 0072, 0081, 0079, 0081, 0046, 0065, 0078, 0123 |
| GOLDSTAR                | 0041   |
| HAMLIN                  | 0081, 0060, 0066, 0067, 0123                   |
| HITACHI                 | 0078   |
| ILLICO                  | 0045   |
| JASCO                   | 0082   |
| JERROLD                 | 0072, 0079, 0081, 0065, 0078, 0076, 0123       |
| MAGNAVOX                | 0075   |
| MEMOREX                 | 0049   |
| MOTOROLA                | 0071, 0081, 0070, 0072, 0079, 0076, 0078, 0065 |
| MOVIE TIME              | 0086   |
| NOVAPLEX                | 0056   |
| NOWTV                   | 0053   |
| NSC                     | 0086   |
| OAK                     | 0064   |
| PANASONIC               | 0044   |
| PARAGON                 | 0049   |
| PHILIPS                 | 0082, 0031, 0075, 0084, 0083, 0085             |
| PHILIPS-MAGNAVOX        | 0054, 0055                                     |
| PIONEER                 | 0041, 0043, 0045, 0034                         |
| PULSAR                  | 0049   |
| QUASAR                  | 0049   |
| RADIO SHACK             | 0035, 0054, 0055, 0059                         |
| RCA                     | 0082, 0047                                     |
| REALISTIC               | 0077, 0124                                     |
| REGAL                   | 0067   |
| REGENCY                 | 0061   |
| REMBRANDT               | 0078   |
| ROGERS                  | 0045   |
| RUNCO                   | 0049   |
| SAMSUNG                 | 0041, 0036                                     |

## Chapter 10: Appendix

|                   |                                    |
|-------------------|------------------------------------|
| SCIENTIFIC        | 0045, 0063,                        |
| ATLANTA           | 0045                               |
| SIGNAL            | 0036                               |
| SIGNATURE         | 0078                               |
| SL MARX           | 0036                               |
| STANDARD          | 0032                               |
| STAR SIGHT        | 0047                               |
| STAR TRAK         | 0058                               |
| STARCOM           | 0081, 0123                         |
| STARGATE          | 0036                               |
| TANDY             | 0080                               |
| TELEVIEW          | 0036                               |
| TEXSCAN           | 0032                               |
| TIME WARNER       | 0045                               |
| TOCOM             | 0065, 0062                         |
| TOSHIBA           | 0049                               |
| TV86              | 0086                               |
| UNIKA             | 0033, 0077,<br>0082, 0124          |
| UNITED CABLE      | 0081, 0123                         |
| UNIVERSAL         | 0033, 0039,<br>0077, 0124          |
| VERIZON           | 0045, 0121                         |
| VIDEO TECH        | 0037                               |
| VIDEOTRON         | 0045                               |
| VIDEOWAY          | 0048                               |
| VIEWSTAR          | 0083, 0075,<br>0086, 0080,<br>0122 |
| VISIONTICS        | 0057                               |
| ZENITH            | 0050, 0059,<br>0049, 0051          |
| ZENITH<br>NETWORK | 0052                               |

### Blu-ray Disc™

| Brand      | Code                               |
|------------|------------------------------------|
| DENON      | 1019, 1029,<br>1030, 1081          |
| HITACHI    | 1019, 1110,<br>1111, 1113          |
| INTGERA    | 1128                               |
| JVC        | 1011, 1012,<br>1013, 1021,<br>1022 |
| KENWOOD    | 1019                               |
| LG         | 1093                               |
| MARANTZ    | 1077, 1078                         |
| MITSUBISHI | 1034, 1035                         |
| ONKYO      | 1128                               |
| PANASONIC  | 1020, 1019,<br>1017, 1018          |
| PHILIPS    | 1133                               |
| PIONEER    | 1069                               |
| SAMSUNG    | 1134                               |
| SHARP      | 1026, 1027,<br>1028                |
| SONY       | 1086, 1087,<br>1088, 1090          |

|         |            |
|---------|------------|
| TOSHIBA | 1000       |
| YAMAHA  | 1065, 1122 |

### DVD

| Brand                      | Code  |
|----------------------------|---|
| AFREEY                     | 1112  |
| ALLEGRO                    | 1093, 1167  |
| AMES                       | 1100, 1170  |
| AMW                        | 1059  |
| APEX                       | 1051, 1053,<br>1096, 1094,<br>1055, 1155  |
| ASPIRE                     | 1036  |
| A-TREND                    | 1112  |
| BLAUPUNKT                  | 1094  |
| BLUESKY                    | 1092, 1053  |
| BLU-RAY                    | 1025, 1137,<br>1016, 1093,<br>1069, 1086,<br>1134, 1145,<br>1160, 1166,<br>1167, 1181 |
| BODYSONIC                  | 1112  |
| BOSE                       | 1006  |
| BROKSONIC                  | 1005  |
| CAVS                       | 1043  |
| CENTRIOS                   | 1040, 1066  |
| CHANGHONG                  | 1155  |
| CINEVISION                 | 1093, 1167  |
| CLASSIC                    | 1100, 1155,<br>1170   |
| COBY                       | 1039, 1042,<br>1040, 1053,<br>1097, 1095,<br>1147                                     |
| CONCEPT                    | 1094  |
| CONIA                      | 1053  |
| CONTEL                     | 1151  |
| CURTIS                     | 1097, 1095  |
| INTERNATIONAL<br>CYBERHOME | 1063, 1112,<br>1064   |
| CYTRON                     | 1048, 1092  |
| DAEWOO                     | 1033, 1032  |
| DENON                      | 1025, 1019,<br>1029, 1030,<br>1081  |
| DENZEL                     | 1059  |
| DESAY                      | 1152  |
| DIAMOND VISION             | 1047  |
| DIGITREX                   | 1053  |
| DISNEY                     | 1117  |
| DRIVE                      | 1153  |
| DUAL                       | 1103, 1048,<br>1059   |
| DURABRAND                  | 1066, 1093,<br>1048, 1103,<br>1167  |
| DVD2000                    | 1031  |

|                  |  |
|------------------|--|
| EMERSON          | 1093, 1117,<br>1167  |
| ESA              | 1103   |
| FISHER           | 1101   |
| FUNAI            | 1117   |
| GE               | 1079, 1094   |
| GOLDSTAR         | 1093, 1167   |
| GO-VIDEO         | 1100, 1060,<br>1032, 1009,<br>1052, 1004,<br>1007, 1170  |
| GPX              | 1100   |
| GRADIENTE        | 1092, 1103,<br>1040  |
| GREENHILL        | 1094   |
| HAAZ             | 1102, 1046   |
| HARMAN<br>KARDON | 1114   |
| HD-DVD           | 1137, 1016,<br>1069, 1086,<br>1129, 1061,<br>1093, 1145,<br>1160, 1166,<br>1167                      |
| HITACHI          | 1070, 1004,<br>1059, 1019,<br>1110, 1111,<br>1113, 1143  |
| HITEKER          | 1053   |
| HUMAX            | 1123   |
| ILO              | 1015, 1094   |
| INFINITY         | 1112   |
| INITIAL          | 1094, 1094   |
| INSIGNIA         | 1117, 1041,<br>1094, 1091,<br>1094, 1093,<br>1093, 1167  |
| INTEGRA          | 1120   |
| IRT              | 1095   |
| JBL              | 1114   |
| JVC              | 1061, 1014,<br>1130, 1010,<br>1011, 1012,<br>1013, 1021,<br>1022, 1139,<br>1140, 1141,<br>1142, 1158 |
| JWIN             | 1053, 1047   |
| KAWASAKI         | 1102, 1066   |
| KENWOOD          | 1019, 1119   |
| KISS             | 1059   |
| KLH              | 1094, 1051,<br>1154  |
| KONKA            | 1049, 1045   |
| KOSS             | 1092, 1092   |
| KXD              | 1095   |
| LASONIC          | 1102   |
| LG               | 1093, 1092,<br>1093, 1093,<br>1167, 1168   |
| LINN             | 1076   |

## Chapter 10: Appendix

|                      |  |               |   |              |  |
|----------------------|--|---------------|---|--------------|--|
| LITEON               | 1109, 1118,<br>1015  | RADIO SHACK   | 1066, 1116  | WESTINGHOUSE | 1084                                     |
| MAGNAVOX             | 1061, 1130,<br>1117, 1131,<br>1158, 1177,<br>1178  | RCA           | 1079, 1092,<br>1094, 1066,<br>1116, 1048  | WHITE        | 1117                                     |
| MARANTZ              | 1061, 1093,<br>1130, 1077,<br>1078, 1157,<br>1158, 1167,<br>1176                               | REGENT        | 1103  | WESTINGHOUSE |  |
| MEDION               | 1015, 1048   | REOC          | 1102  | X-BOX        | 1079                                     |
| MEMOREX              | 1005, 1048   | RIO           | 1093, 1167  | XENIUS       | 1092                                     |
| MERIDIAN             | 1061   | RJ TECHNOLOGY | 1041, 1038,<br>1149   | YAMAHA       | 1130, 1122,<br>1131, 1158,<br>1159, 1178 |
| MICROSOFT            | 1079   | ROTEL         | 1014  | YAMAKAWA     | 1056, 1059,<br>1065                      |
| MINTEK               | 1094   | SAMSUNG       | 1134, 1136,<br>1004, 1009,<br>1008, 1007,<br>1134, 1138,<br>1180, 1181  | ZENITH       | 1061, 1093,<br>1167                      |
| MITSUBISHI           | 1094, 1034,<br>1035  | SAMPO         | 1112  |              |  |
| MUSTEK               | 1100, 1170   | SANSUI        | 1005  |              |  |
| MYRON&DAVIS          | 1040   | SANYO         | 1066, 1101  |              |  |
| NAD                  | 1093, 1167   | SEARS         | 1005  |              |  |
| NEC                  | 1093, 1167   | SEG           | 1059  |              |  |
| NESA                 | 1094, 1040   | SELECTRON     | 1037, 1040  |              |  |
| NEXXTECH             | 1041, 1091,<br>1066, 1051,<br>1059, 1103,<br>1040, 1099,<br>1148, 1171                         | SEMP          | 1092  |              |  |
| NORCENT              | 1039, 1109,<br>1041, 1097  | SHARP         | 1137, 1044,<br>1026, 1027,<br>1028  |              |  |
| ONKYO                | 1061, 1120,<br>1128, 1157  | SHERWOOD      | 1115  |              |  |
| OPTIMUS              | 1070, 1162   | SHINCO        | 1094  |              |  |
| ORION                | 1005   | SHINSONIC     | 1094  |              |  |
| ORITRON              | 1092   | SONIC BLUE    | 1060  |              |  |
| PACIFIC              | 1048   | SONY          | 1083, 1089,<br>1084, 1082,<br>1085, 1086,<br>1087, 1088,<br>1090, 1166  |              |  |
| PANASONIC            | 1016, 1020,<br>1019, 1024,<br>1023, 1143,<br>1144, 1145  | SUNGALE       | 1041, 1040,<br>1147, 1150   |              |  |
| PHILIPS              | 1092, 1133,<br>1117, 1131,<br>1061, 1130,<br>1175, 1177,<br>1178, 1179                         | SVA           | 1053, 1044  |              |  |
| PHILIPS-<br>MAGNAVOX | 1061, 1130,<br>1131, 1178  | SYLVANIA      | 1117  |              |  |
| PIONEER              | 1069, 1069,<br>1070, 1071,<br>1074, 1072,<br>1123, 1160,<br>1161, 1162,<br>1163, 1164,<br>1165 | SYMPHONIC     | 1117  |              |  |
| PIVA                 | 1146   | TASCAM        | 1014  |              |  |
| POLAROID             | 1058, 1121,<br>1047, 1051,<br>1095, 1169   | TEAC          | 1070, 1066,<br>1093, 1167   |              |  |
| POLK AUDIO           | 1061, 1130   | TECHNICS      | 1019  |              |  |
| PROLINE              | 1092   | TECHWOOD      | 1130  |              |  |
| PROSCAN              | 1079   | TEVION        | 1092, 1048,<br>1103, 1102,<br>1046  |              |  |
| PROSONIC             | 1039   | THETA DIGITAL | 1070  |              |  |
| PROTRON              | 1041   | TIVO          | 1123  |              |  |
|                      |  | TOSHIBA       | 1129, 1005,<br>1104, 1061,<br>1108, 1001,<br>1002, 1003,<br>1105, 1106,<br>1107, 1156,<br>1172, 1173,<br>1174 |              |  |
|                      |  | TRUTECH       | 1063, 1032  |              |  |
|                      |  | UNITED        | 1066  |              |  |
|                      |  | VENTURER      | 1104, 1066,<br>1172   |              |  |
|                      |  | WHARFEDALE    | 1112  |              |  |

### DVD Recorders

| Brand                | Code  |
|----------------------|---|
| ASTAR                | 1050, 1095  |
| APEX                 | 1054  |
| ASPIRE               | 1057, 1036  |
| BROKSONIC            | 1067  |
| BUSH                 | 1068  |
| COBY                 | 1095  |
| CYBERHOME            | 1064  |
| EMERSON              | 1117  |
| GO-VIDEO             | 1052, 1098,<br>1100, 1135                         |
| HITACHI              | 1018, 1113  |
| HUGHES               | 1117  |
| HUGHES<br>NETWORK    | 1117, 1127  |
| HUMAX                | 1126  |
| ILO                  | 1015  |
| INSIGNIA             | 1093  |
| JVC                  | 1013, 1012,<br>1010, 1011                         |
| KXD                  | 1095  |
| LG                   | 1093  |
| LITEON               | 1015, 1098  |
| MAGNAVOX             | 1131, 1117  |
| MEDION               | 1015  |
| MEMOREX              | 1048  |
| MUSTEK               | 1100  |
| PANASONIC            | 1018, 1017,<br>1019, 1020                         |
| PHILIPS              | 1127, 1125,<br>1075, 1117,<br>1131, 1132,<br>1098 |
| PHILIPS-<br>MAGNAVOX | 1131  |
| PIONEER              | 1070, 1126,<br>1073, 1074                         |
| POLAROID             | 1095, 1058  |
| RCA                  | 1080, 1079  |
| SAMSUNG              | 1135, 1004,<br>1136                               |
| Sansui               | 1068  |
| SANYO                | 1101  |
| SHARP                | 1137  |



## Chapter 10: Appendix

SONY 1084, 1083, 1089  
 SYLVANIA 1117  
 SYMPHONIC 1117  
 TIVO 1062, 1125, 1126, 1126  
 TOSHIBA 1062, 1061, 1106, 1107, 1108  
 TRUTECH 1063  
 YAMAHA 1018, 1131  
 ZENITH 1093

DAEWOO 2000, 2027, 2051, 2019, 2039  
 DBX 2011, 2012, 2021  
 DENON 2043  
 DIMENSIA 2060  
 DURABRAND 2033, 2074  
 DYNATECH 2047, 2000  
 ELECTROHOME 2033, 2018  
 ELECTROPHONIC 2033  
 EMERSON 2051, 2033, 2019, 2003, 2052, 2015, 2005, 2073, 2007, 2027, 2084, 2047, 2082, 2075, 2024, 2001, 2087, 2088, 2040, 2049, 2020, 2000, 2018, 2035, 2038, 2036, 2091, 2081, 2046, 2034, 2083

JC PENNEY 2060, 2033, 2024, 2007, 2030, 2011, 2012, 2046, 2017, 2077, 2044, 2021  
 JCL 2046  
 JENSEN 2030, 2017  
 JVC 2011, 2012, 2024, 2010, 2013, 2021, 2017

KENWOOD 2024, 2011, 2012, 2021, 2017  
 KLH 2086  
 KODAK 2033, 2046  
 LG 2047, 2090, 2076, 2074  
 LLOYD 2047, 2000  
 LOGIK 2086  
 LXI 2047, 2033  
 MAGNAVOX 2046, 2056, 2090, 2047, 2062, 2060, 2056, 2047, 2088, 2089

MAGNIN 2007  
 MARANTZ 2056, 2024, 2011, 2012, 2081, 2046, 2004, 2021  
 MARTA 2033  
 MATSUSHITA 2046  
 MEI 2046  
 MEMOREX 2056, 2033, 2024, 2022, 2005, 2090, 2007, 2062, 2047, 2048, 2023, 2000, 2046

MGA 2015, 2018  
 MGN TECHNOLOGY 2007  
 MIDLAND 2029  
 MINOLTA 2030, 2077  
 MITSUBISHI 2015, 2016, 2030, 2011, 2012, 2006, 2018

MONTGOMERY WARD 2062, 2092  
 MOTOROLA 2062, 2046  
 MTC 2047, 2007, 2000  
 MULTITECH 2047, 2007, 2000, 2029, 2086

FISHER 2022, 2024, 2056, 2021, 2023, 2031, 2032, 2078  
 FUJI 2065, 2046  
 FUNAI 2047, 2088, 2087, 2000

GARRARD 2000  
 GE 2007, 2060, 2061, 2029, 2046

GOLDSTAR 2047, 2033, 2076, 2090, 2021

GO-VIDEO 2019, 2085, 2007  
 GRADIENTE 2000, 2033  
 HARLEY DAVIDSON 2000

HARMAN 2021, 2018  
 KARDON  
 HARWOOD 2086  
 HEADQUARTER 2024  
 HI-Q 2023  
 HITACHI 2030, 2047, 2079, 2017, 2077, 2080

INFINITY 2056  
 INSIGNIA 2033, 2074  
 INSTANT REPLAY 2047, 2046  
 INTEO 2033

### VCR

| Brand         | Code   |
|---------------|--|
| ACCELE        | 2007   |
| ADMIRAL       | 2062   |
| ADVENTURA     | 2000   |
| AIKO          | 2019   |
| AIWA          | 2033, 2047, 2001, 2000                         |
| AKAI          | 2047, 2065, 2041, 2040, 2018, 2017, 2048       |
| ALLEGRO       | 2010, 2090, 2033, 2074                         |
| AMERICAN HIGH | 2046   |
| ASHA          | 2007   |
| AUDIO         | 2011, 2012,                                    |
| DYNAMICS      | 2021   |
| AUDIOVOX      | 2033   |
| BEAUMARK      | 2007   |
| BELL&HOWELL   | 2024   |
| BROKSONIC     | 2003, 2051, 2052, 2005, 2002, 2049, 2081       |
| CALIX         | 2033   |
| CANDLE        | 2027, 2033, 2007, 2021, 2039                   |
| CANON         | 2060, 2004, 2046                               |
| CAPEHART      | 2090   |
| CARVER        | 2056   |
| CCE           | 2019, 2086                                     |
| CINEVISION    | 2033, 2074                                     |
| CITIZEN       | 2027, 2033, 2019, 2007, 2021, 2039             |
| COLORTYME     | 2021   |
| COLT          | 2086   |
| CRAIG         | 2033, 2007, 2086, 2023                         |
| CURTIS MATHES | 2060, 2056, 2047, 2019, 2007, 2021, 2020, 2046 |
| CYBERNEX      | 2007   |

## Chapter 10: Appendix

|                      |   |           |  |                |   |
|----------------------|---|-----------|--|----------------|---|
| NEC                  | 2024, 2011,<br>2012, 2081,<br>2034, 2050,<br>2017, 2021,<br>2020  | RICOH     | 2067   | TOSHIBA        | 2027, 2028,<br>2026, 2056,<br>2015, 2007,<br>2030, 2032,<br>2075  |
| NEXXTECH             | 2042  | RIO       | 2033, 2074   | TOTEVISION     | 2033, 2007  |
| NIKKO                | 2033  | RUNCO     | 2090   | TRUTECH        | 2019  |
| NOBLEX               | 2007  | SAMSUNG   | 2008, 2048,<br>2027, 2030,<br>2007, 2009   | UNITECH        | 2007  |
| OLYMPUS              | 2046  | SAMTRON   | 2007   | VECTOR         | 2027, 2011,   |
| OPTIMUS              | 2033, 2007,<br>2014, 2033,<br>2063, 2014,<br>2062   | SANKY     | 2062, 2090   | RESEARCH       | 2012, 2021  |
| OPTONICA             | 2007, 2092  | SANSUI    | 2005, 2011,<br>2012, 2002,<br>2003, 2017   | VICTOR         | 2011, 2012  |
| ORION                | 2003, 2005  | SANYO     | 2025, 2022,<br>2024, 2007,<br>2023, 2078   | VIDEO CONCEPTS | 2027, 2011,<br>2012, 2021,<br>2018  |
| PANASONIC            | 2014, 2014,<br>2046, 2060   | SCOTT     | 2027, 2051,<br>2052, 2015,<br>2075, 2049,<br>2036  | VIDEOSONIC     | 2007  |
| PENTAX               | 2030, 2021,<br>2077   | SEARS     | 2014, 2033,<br>2024, 2056,<br>2030, 2002,<br>2088, 2023,<br>2031, 2032,<br>2046, 2077,<br>2044, 2039 | WARDS          | 2060, 2062,<br>2047, 2027,<br>2033, 2007,<br>2030, 2023,<br>2000, 2018,<br>2046, 2092,<br>2077, 2075,<br>2086                               |
| PHILCO               | 2056, 2060,<br>2047, 2046   | SHARP     | 2063, 2062,<br>2047, 2082,<br>2018, 2092   | WHITE          | 2047, 2019,   |
| PHILIPS              | 2056, 2057,<br>2088, 2056,<br>2046, 2089  | SHINTOM   | 2065, 2067,<br>2030, 2086,<br>2037   | WESTINGHOUSE   | 2000, 2046,<br>2086   |
| PHILIPS-<br>MAGNAVOX | 2056, 2062  | SHOGUN    | 2007   | XR-1000        | 2021, 2017,<br>2011, 2012   |
| PILOT                | 2033  | SIGNATURE | 2047   | YAMAHA         | 2090, 2010,<br>2019, 2082,<br>2067, 2007,<br>2033, 2065,<br>2005, 2025,<br>2011, 2085,<br>2090, 2074,<br>2056, 2062,<br>2047, 2076,<br>2079 |
| PIONEER              | 2043, 2030,<br>2011, 2012,<br>2045, 2044  | SINGER    | 2046, 2086   | ZENITH         |   |
| PORTLAND             | 2039  | SONY      | 2064, 2068,<br>2065, 2066,<br>2067, 2070,<br>2069, 2071,<br>2072                                     |                |   |
| PROSCAN              | 2060, 2059  | STS       | 2030, 2046,<br>2077  | <b>CD</b>      |   |
| PROTEC               | 2086  | SUPERSCAN | 2088   | <b>Brand</b>   | <b>Code</b>   |
| PULSAR               | 2090  | SYLVANIA  | 2000, 2047,<br>2056, 2015,<br>2060, 2088,<br>2046, 2047,<br>2087                                     | ADCOM          | 3018  |
| QUARTER              | 2024  | SYMPHONIC | 2047, 2047,<br>2088, 2000,<br>2087   | AIWA           | 3002, 3047,<br>3001   |
| QUARTZ               | 2024  | TANDY     | 2047, 2024   | AKAI           | 3025, 3024,<br>3025   |
| QUASAR               | 2014, 2060,<br>2014, 2046   | TASHIKO   | 2033   | AUDIO TECHNICA | 3022  |
| RADIO SHACK          | 2060, 2062,<br>2047, 2048,<br>2033, 2024,<br>2061, 2007,<br>2063, 2014,<br>2023, 2000,<br>2018, 2032,<br>2046, 2092 | TATUNG    | 2017   | CALIFORNIA     | 3039  |
| RADIX                | 2033  | TEAC      | 2047, 2000,<br>2017  | AUDIO LABS     |   |
| RANDEX               | 2033  | TECHNICS  | 2046   | CARVER         | 3043, 3016,<br>3017, 3042   |
| RCA                  | 2060, 2033,<br>2059, 2054,<br>2060, 2053,<br>2055, 2061,<br>2007, 2030,<br>2041, 2029,<br>2046, 2077,<br>2058       | TEKNIKA   | 2047, 2033,<br>2073, 2000,<br>2046   | CASIO          | 3000  |
| REALISTIC            | 2060, 2062,<br>2047, 2033,<br>2024, 2007,<br>2063, 2014,<br>2023, 2000,<br>2018, 2032,<br>2046, 2092,<br>2048       | TMK       | 2007, 2020,<br>2034  | CITIZEN        | 3052  |
|                      |   |           |  | CURTIS MATHES  | 3000  |
|                      |   |           |  | DENON          | 3045  |
|                      |   |           |  | EMERSON        | 3018, 3004  |
|                      |   |           |  | FISHER         | 3016, 3014,<br>3071, 3073,<br>3016  |
|                      |   |           |  | GENEXXA        | 3004, 3037,<br>3053   |

## Chapter 10: Appendix

HARMAN 3013  
 KARDON  
 HITACHI 3037  
 INSIGNIA 3078  
 JC PENNEY 3033, 3000  
 JVC 3008, 3007  
 KENWOOD 3046, 3028,  
 3027, 3026,  
 3029, 3028  
 KRELL 3043  
 LUXMAN 3031, 3059,  
 3063, 3066  
 LXI 3000  
 MAGNAVOX 3043, 3041  
 MARANTZ 3043, 3061,  
 3057, 3038  
 MCS 3033, 3000  
 MGA 3013  
 MISSION 3043  
 MITSUBISHI 3013, 3012  
 NAD 3067  
 NEC 3033  
 NEXXTECH 3050  
 NIKKO 3022, 3004,  
 3071  
 NSM 3043  
 ONKYO 3032, 3068,  
 3070, 3069  
 OPTIMUS 3016, 3017,  
 3037, 3046,  
 3064, 3056,  
 3062, 3058,  
 3036, 3036,  
 3035  
 PANASONIC 3039, 3009,  
 3010, 3039,  
 3011  
 PHILIPS 3043, 3041,  
 3042  
 PIONEER 3036, 3037,  
 3036, 3037,  
 3053, 3036,  
 3034, 3036  
 PROTON 3043  
 QUASAR 3039  
 RADIO SHACK 3017, 3062,  
 3055, 3036,  
 3050, 0868,  
 3044, 3036  
 RCA 3018, 3016,  
 3040, 3003,  
 3036, 3044,  
 3044, 3044,  
 3044, 3036  
 REALISTIC 3018, 3016,  
 3004, 3037,  
 3057, 0697,  
 3062  
 ROTEL 3043  
 SAE 3043  
 SAMSUNG 3077

SANSUI 3043, 3038,  
 3003, 3006  
 SANYO 3016, 3016,  
 3016, 3015,  
 3030  
 SCOTT 3018, 3004  
 SEARS 3046, 3057,  
 3000  
 SHARP 3046, 3057  
 SHERWOOD 3005, 3057,  
 3056, 3055  
 SHURE 3033  
 SONY 3075, 3076  
 SYLVANIA 3043  
 SYMPHONIC 3048  
 TEAC 3071, 3057,  
 3062, 3048,  
 3065, 3054,  
 3060  
 TECHNICS 3039, 3009,  
 3039, 3011  
 THETA DIGITAL 3041  
 TOSHIBA 3067  
 VICTOR 3008  
 YAMAHA 3022, 3020,  
 3021, 3023,  
 3019  
 ZENITH 3071, 3049,  
 3072, 3074,  
 3051

### Receiver & amp

| <b>Brand</b>     | <b>Code</b>                        |
|------------------|------------------------------------|
| AIWA             | 4001, 4003                         |
| APEX             | 4020                               |
| APPLE IPOD       | 4080                               |
| BOSE             | 4007, 4081,<br>4082                |
| CARVER           | 4042                               |
| CENTRIOS         | 4021, 4020,<br>4019                |
| CITIZEN          | 4069                               |
| DELPHI           | 4044                               |
| DENON            | 4049, 4051,<br>4050, 4090,<br>4091 |
| FISHER           | 4068, 4067                         |
| GOLDSTAR         | 4018                               |
| HARMAN<br>KARDON | 4072, 4005                         |
| IPOD             | 4066                               |
| JVC              | 4011, 4010,<br>4009                |
| KENWOOD          | 4077, 4032                         |
| KOSS             | 4061                               |
| MAGNAVOX         | 4069, 4068,<br>4042                |
| MARANTZ          | 4074, 4042                         |
| NAD              | 4076                               |
| NELSON           | 4019                               |

NEO 4044  
 NEXXTECH 4020, 4019,  
 4004  
 ONKYO 4078, 4079  
 OPTIMUS 4024, 4035,  
 4002, 4012,  
 4034, 4036,  
 4037  
 PANASONIC 4093, 4092,  
 4014, 4043,  
 4014, 4015,  
 4016, 4013,  
 4017  
 PHILIPS 4061, 4068,  
 4043, 4042,  
 4042, 4042,  
 4083  
 PIONEER 4036, 4040,  
 4034, 4041,  
 4033, 4038,  
 4037, 4036,  
 4039  
 RADIO SHACK 4036, 4037,  
 4038, 4075,  
 4073  
 RCA 4031, 4046,  
 4023, 4036,  
 4037, 4038,  
 4048, 4045,  
 4047, 4073,  
 4075  
 RIO 4063, 4025  
 SAMSUNG 4008  
 SANYO 4024  
 SHARP 4053, 4022,  
 4052  
 SHERWOOD 4006  
 SIRIUS 4022  
 SKYFI 4044  
 SONY 4088, 4054,  
 4055, 4087,  
 4057, 4058,  
 4056, 4060,  
 4089, 4059  
 TAO 4044  
 TECHNICS 4093, 4092,  
 4014, 4043,  
 4014, 4015  
 TOSHIBA 4000  
 WONDER 4021  
 XM RADIO 4044, 4044  
 YAMAHA 4030, 4028,  
 4026, 4027,  
 4029, 4070,  
 4071  
 ZENITH 4084, 4062,  
 4012, 4085,  
 4064, 4018,  
 4086, 4068,  
 4025, 4065

## Limited United States Warranty for LCD Televisions

Toshiba America Information Systems, Inc. ("TAIS") makes the following limited warranties to original consumers in the United States.

THESE LIMITED WARRANTIES EXTEND TO THE ORIGINAL CONSUMER PURCHASER OR ANY PERSON RECEIVING THIS LCD TELEVISION AS A GIFT FROM THE ORIGINAL CONSUMER PURCHASER AND TO NO OTHER PURCHASER OR TRANSFEREE. LCD TELEVISIONS PURCHASED IN THE U.S.A. OR PUERTO RICO AND USED ANYWHERE OUTSIDE OF THE U.S.A. OR PUERTO RICO, INCLUDING, WITHOUT LIMITATION, CANADA AND MEXICO, ARE NOT COVERED BY THESE WARRANTIES. LCD TELEVISIONS PURCHASED ANYWHERE OUTSIDE OF THE U.S.A. OR PUERTO RICO, INCLUDING, WITHOUT LIMITATION, CANADA AND MEXICO, AND USED IN THE U.S.A., ARE NOT COVERED BY THESE WARRANTIES.

### Limited One (1) Year Warranty on Parts and Labor

TAIS WARRANTS THIS LCD TELEVISION AND ITS PARTS AGAINST DEFECTS IN MATERIALS OR WORKMANSHIP FOR A PERIOD OF ONE (1) YEAR FROM THE DATE OF ORIGINAL RETAIL PURCHASE. DURING THIS PERIOD, TAIS WILL, AT TAIS' SOLE DISCRETION, REPAIR OR REPLACE A DEFECTIVE PART/PRODUCT WITH A NEW OR REFURBISHED PART/PRODUCT WITHOUT CHARGE TO YOU FOR PARTS OR LABOR. ANY PART OR PRODUCT REPLACED UNDER THIS LIMITED WARRANTY BECOMES THE PROPERTY OF TAIS. IN SOME CASES, YOU MAY BE RESPONSIBLE FOR DELIVERING THE PRODUCT TO A SERVICE CENTER.

### Rental Units

The limited warranty period begins on the date of the first rental or thirty (30) days after the date of shipment to the rental firm, whichever comes first.

### Your Responsibility

Read the owner's manual thoroughly before installing or operating this LCD Television. Complete and mail the enclosed product registration card (if provided) or register your LCD Television online at [www.support.toshiba.com](http://www.support.toshiba.com). Registration of your LCD Television will enable TAIS to contact you in the unlikely event a safety notification is required under the U.S. Consumer Product Safety Act. Failure to complete and return the product registration card does not diminish your warranty rights.

THE ABOVE WARRANTIES ARE SUBJECT TO THE FOLLOWING CONDITIONS:

- (1) This Limited Warranty is extended only to the original purchaser and only covers product purchased as new.
- (2) A purchase receipt or other proof of the original purchase date is required for warranty service.

- (3) All warranty servicing of this LCD Television must be performed by an Authorized TAIS Service Provider.
- (4) The warranties from TAIS are effective only if this LCD Television is purchased and operated in the U.S.A. or Puerto Rico.
- (5) Removal and reinstallation of product that is mounted in such a manner as to impede normal service is not covered under these warranties. This includes wall mounts, custom cabinets and other installation methods that do not provide for direct and immediate access to the product for service purposes. Labor service charges for set installation, setup, adjustment of customer controls, and installation or repair of antenna, satellite or cable systems are not covered by this limited warranty.
- (6) Reception or other problems caused by inadequate antenna systems, misaligned satellite dishes, improperly installed cable drops or use with non-standard signals or sources are your responsibility and are not covered by this limited warranty.
- (7) This limited warranty is void if the product is used outside the range of the temperature (heat/cold) and/or moisture operating conditions as outlined in the product's specification listed in the Owner's manual, or if the product is exposed to excessive smoke, dust, or other airborne contaminants or environmental conditions.
- (8) Warranties extend only to defects in materials or workmanship as limited above, and do not extend to any LCD Television or parts that have been lost or discarded by you or to damage to the LCD Television or parts caused by fires, misuse, abuse, accident, Acts of God (such as lightning or fluctuations in electric power), improper installation, improper maintenance, or use in violation of instructions furnished by TAIS; use or malfunction through simultaneous use of this LCD Television and connected equipment; or to units that have been modified or had the serial number removed, altered, defaced, or rendered illegible.
- (9) Product purchased "AS-IS" or "With known faults, defects or problems" are not covered by this limited warranty.
- (10) Product previously owned or registered by a consumer and resold is not covered by this limited warranty.
- (11) Product that is refurbished and resold is not covered under this limited warranty.

### How to Obtain Warranty Service

After following all of the operating instructions in the Owner's Manual, review the section entitled "Concierge" located on our Customer Support Web site at [www.support.toshiba.com](http://www.support.toshiba.com). If you find that service is needed, follow the instructions provided on the web site or please contact TAIS' Consumer Solution Center toll free at 1-800-631-3811. You must present upon request your original bill of sale or other proof of purchase including the serial number for in-warranty service.

ALL WARRANTIES IMPLIED BY THE LAW OF ANY STATE OF THE U.S.A., INCLUDING THE IMPLIED WARRANTIES OF MERCHANTABILITY AND FITNESS FOR A PARTICULAR PURPOSE, ARE EXPRESSLY LIMITED TO THE DURATION OF THE LIMITED WARRANTIES SET FORTH ABOVE. WITH

THE EXCEPTION OF ANY WARRANTIES IMPLIED BY THE LAW OF ANY STATE OF THE U.S.A. AS HEREBY LIMITED, THE FOREGOING LIMITED WARRANTY IS EXCLUSIVE AND IN LIEU OF ALL OTHER WARRANTIES, GUARANTEES, AGREEMENTS, AND SIMILAR OBLIGATIONS OF TAIS WITH RESPECT TO THE REPAIR OR REPLACEMENT OF ANY PARTS. IN NO EVENT SHALL TAIS BE LIABLE FOR CONSEQUENTIAL OR INCIDENTAL DAMAGES (INCLUDING, BUT NOT LIMITED TO, LOST PROFITS, BUSINESS INTERRUPTION, OR MODIFICATION OR ERASURE OF RECORDED DATA CAUSED BY USE, MISUSE OR INABILITY TO USE THIS LCD TELEVISION).

No person, agent, distributor, dealer or company is authorized to change, modify or extend the terms of these warranties in any manner whatsoever. The time within which an action must be commenced to enforce any obligation of TAIS arising under this limited warranty or under any statute, or law of the United States or any state thereof, is hereby limited to ninety (90) days from the date you discover or should have discovered, the defect. This limitation does not apply to implied warranties arising under the law of any state of the U.S.A.

THIS LIMITED WARRANTY GIVES YOU SPECIFIC LEGAL RIGHTS AND YOU MAY ALSO HAVE OTHER RIGHTS WHICH MAY VARY FROM STATE TO STATE IN THE U.S.A. SOME STATES OF THE U.S.A. DO NOT ALLOW LIMITATIONS ON THE DURATION OF AN IMPLIED WARRANTY, WHEN AN ACTION MAY BE BROUGHT, OR THE EXCLUSION OR LIMITATION OF INCIDENTAL OR CONSEQUENTIAL DAMAGES. THEREFORE, THE ABOVE PROVISIONS MAY NOT APPLY TO YOU UNDER SUCH CIRCUMSTANCES.

---

## **Limited Canadian Warranty for Toshiba Brand Flat Panel Televisions**

---

Toshiba of Canada Limited ("TCL") makes the following limited warranties to original consumers in Canada. THESE LIMITED WARRANTIES EXTEND TO THE ORIGINAL CONSUMER PURCHASER OR ANY PERSON RECEIVING THIS TOSHIBA BRAND FLAT PANEL TELEVISION (the "TELEVISION(S)" or "Television(s)") AS A GIFT FROM THE ORIGINAL CONSUMER PURCHASER AND TO NO OTHER PURCHASER OR TRANSFEREE.

TELEVISIONS PURCHASED IN CANADA, AND USED ANYWHERE OUTSIDE OF CANADA INCLUDING, WITHOUT LIMITATION, THE UNITED STATES AND MEXICO, ARE NOT COVERED BY THESE WARRANTIES.

TELEVISIONS PURCHASED ANYWHERE OUTSIDE OF CANADA, INCLUDING, WITHOUT LIMITATION, THE UNITED STATES AND MEXICO, AND USED IN CANADA, ARE NOT COVERED BY THESE WARRANTIES.

### **Limited One (1) Year Warranty on Parts and Labour**

TCL warrants the Television and its parts against material defects in materials or workmanship that result in the Television failing for a period of one (1) year after the date of original retail purchase. DURING THIS PERIOD, TCL WILL, AT TCL'S SOLE OPTION, REPAIR OR REPLACE A DEFECTIVE PART WITH A NEW OR RECERTIFIED PART WITHOUT CHARGE TO YOU FOR PARTS OR LABOUR.

### **Rental Units**

The warranty for Television rental units begins with the date of first rental or thirty (30) days from the date of shipment to the rental firm, whichever comes first.

### **Your Responsibility**

Read the Owner's Manual thoroughly before operating this LCD Television. Register your LCD Television online at <http://support.toshiba.ca/warranty/>. Registration of your LCD Television will enable TCL to contact you in the unlikely event of a product safety notice. Failure to complete the product registration does not diminish your warranty rights.

**THE ABOVE WARRANTIES ARE SUBJECT TO THE FOLLOWING CONDITIONS:**

- (1) You must provide your bill of sale or other proof of purchase.
- (2) All warranty servicing of this Television must be performed by a Toshiba Authorized Service Provider (ASP).
- (3) The warranties from TCL are effective only if the Television is (i) purchased as new and unopened from TCL or from TCL's authorized distributors, dealers or resellers ("ADR's") and (ii) located/operated in Canada.
- (4) Removal and installation of product that is mounted in such a manner as to impede normal service is not covered under these warranties. This includes wall mounts, custom cabinets and other installation methods

that do not provide for direct and immediate access to the product for service purposes. Labour charges for set installation, setup, adjustment of customer controls, and installation or repair of antenna systems are not covered by these warranties. Reception problems caused by inadequate antenna systems are your responsibility.

- (5) Warranties extend only to material defects in materials or workmanship as limited above, and do not extend to:
- Service, repairs or replacement made necessary by accident, misuse, abuse, moisture, liquids, dust, dirt, neglect, accident, damage, 24/7 applications, improper installation, improper operation, improper cleaning, improper maintenance, normal wear and tear, screen burn or image retention caused by prolonged display of static images and/or phosphor aging, or any other external cause or event, act or omission outside the control of TCL, including fire, theft, acts of God, alteration, power failures, power surges or power shortages, lightning, other electrical faults, or repairs, modifications or replacements by persons other than those authorized by TCL to service the Television;
  - Replacement of missing, discarded or lost parts, the provision of retrofits, or preventive maintenance;
  - Repair of damage that is cosmetic only or does not affect the Television functionality, such as wear and tear, scratches and dents;
  - Service on Toshiba-branded accessory items (such as accessory items may be covered by their own warranty);
  - Service on third party products or service made necessary by use of incompatible third party products;
  - Service made necessary by the simultaneous use of this Television and connected equipment;
  - Modifications to the Television not approved in writing by TCL, and service made necessary by the use or installation of non-Toshiba modifications to the Television;
  - Service of a Television on which the TOSHIBA label or logo, rating label or serial number have been defaced or removed;
  - Damage to the Television caused by failure to follow the specifications, User manuals or guides as to usage and/or storage.

### Disclaimer and Limitation of Remedy

TO THE EXTENT NOT PRECLUDED BY LAW, ALL OTHER EXPRESS AND IMPLIED WARRANTIES, CONDITIONS AND REPRESENTATIONS FOR THIS TELEVISION, INCLUDING THE IMPLIED WARRANTIES, CONDITIONS AND REPRESENTATIONS OF MERCHANTABILITY AND FITNESS FOR A PARTICULAR PURPOSE, ARE HEREBY DISCLAIMED AND EXCLUDED. IF THE APPLICABLE LAW, STATUTORY OR OTHERWISE, PRECLUDES THE EXCLUSION OF ANY IMPLIED WARRANTIES, CONDITIONS AND REPRESENTATIONS THEN SUCH IMPLIED WARRANTIES, CONDITIONS AND REPRESENTATIONS ARE OTHERWISE LIMITED IN DURATION TO THE TERM OF THIS EXPRESS

WRITTEN LIMITED WARRANTY. TO THE EXTENT NOT PRECLUDED BY LAW, STATUTORY OR OTHERWISE, THIS WRITTEN WARRANTY SUPERCEDES AND SPECIFICALLY DISCLAIMS ANY OTHER WARRANTY, CONDITION OR REPRESENTATION NOT STATED IN THIS WARRANTY, WHETHER MADE BY TCL, TOSHIBA CORPORATION, THEIR AFFILIATES, ADRs AND ASPs AND WHETHER MADE ORALLY OR IN WRITING (INCLUDING ANY STATEMENT IN ANY BROCHURE, PRESS RELEASE, ANNOUNCEMENT, ADVERTISEMENT, POINT OF SALE DISPLAY, ETC.).

YOU MUST READ AND FOLLOW ALL SET-UP AND USAGE INSTRUCTIONS IN THE APPLICABLE USER GUIDES AND/OR MANUALS. IF YOU FAIL TO DO SO, THIS TELEVISION MAY NOT FUNCTION PROPERLY AND YOU MAY SUFFER DAMAGE. THIS WARRANTY WILL NOT COVER ANY SERVICE THAT IS REQUIRED, IN PART OR IN WHOLE, AS A RESULT OF ANY FAILURE TO FOLLOW THE SET-UP AND USAGE INSTRUCTIONS. THIS WARRANTY DOES NOT APPLY AND SHALL BE VOID AND UNENFORCEABLE IF THE TELEVISION IS OPENED, SERVICED, OR REPAIRED BY PERSONS OTHER THAN THOSE AUTHORIZED BY TCL TO SERVICE OR REPAIR THE TELEVISION.

IF THE TELEVISION FAILS TO WORK AS WARRANTED ABOVE, YOUR SOLE AND EXCLUSIVE REMEDY SHALL BE REPAIR OR REPLACEMENT OF THE DEFECTIVE PART. IN NO EVENT WILL TCL, TOSHIBA CORPORATION, THEIR AFFILIATES, ADRs OR ASPs (THE "RELATED PARTIES") BE LIABLE TO YOU OR ANY THIRD PARTY FOR ANY DAMAGES, MONEY, REIMBURSEMENT, COSTS OR EXPENSES. THIS LIMITATION APPLIES TO DAMAGES, MONEY, REIMBURSEMENT, COSTS OR EXPENSES OF ANY KIND WHATSOEVER INCLUDING ANY DIRECT OR INDIRECT DAMAGES, DAMAGE TO PROPERTY OR PERSON, LOST PROFITS, LOST SAVINGS, INCONVENIENCE OR OTHER SPECIAL, INCIDENTAL, EXEMPLARY OR CONSEQUENTIAL DAMAGES, WHETHER FOR BREACH OF WARRANTY, BREACH OF CONTRACT, TORT (INCLUDING NEGLIGENCE), UNDER A STATUTE OR UNDER ANY OTHER LAW OR FORM OR ACTION, OR WHETHER ARISING OUT OF THE USE OF OR INABILITY TO USE THE TELEVISION, EVEN IF ANY OF THE RELATED PARTIES HAS BEEN ADVISED OF THE POSSIBILITY OF SUCH DAMAGES OR OF ANY CLAIM BY ANY OTHER PARTY.

No person, agent, distributor, dealer or company is authorized to change, modify or extend the terms of these warranties in any manner whatsoever.

### Arbitration and Dispute Resolution

To the extent not precluded by law, any claim, dispute, controversy or disagreement (whether for breach of warranty, breach of contract, tort (including negligence), under a statute or under any other law or form of action) against any of the Related Parties arising out of, or otherwise relating to: (i) this warranty; (ii) the Television; (iii) any oral or written representations, statements, brochures, press releases, advertising, announcement, point of sale display, or



promotional material relating to the Television; (iv) the relationships that result from this warranty, (the foregoing claims, disputes controversies and disagreements are collectively referred to as the "Dispute"), shall be referred to and resolved by final and binding arbitration (to the exclusion of the courts). To the extent not precluded by law, you agree to waive any right that you may have to commence or participate in any representative or class proceeding against the Related Parties relating to any Dispute. If and where applicable and to the extent not precluded by law, you further agree to opt out of any such representative or class proceedings. Arbitration of any Dispute will be conducted in the forum and in the manner as agreed to between you and TCL. Failing such agreement, the arbitration will be conducted by one arbitrator pursuant to the laws and rules relating to arbitration generally in force in the jurisdiction in which you reside at the time that the Dispute arises. To the extent not precluded by law, no claim, dispute, controversy or disagreement of any other person may be joined or combined with any Dispute by you, without the prior written consent of TCL.

### Critical Applications

The Television you have purchased is not designed for any "critical applications." "Critical applications" means life support systems, medical applications, connections to implanted medical devices, commercial transportation, nuclear facilities or systems or any other applications where Television failure could lead to injury to persons or loss of life or catastrophic property damage.

IF THE CUSTOMER USES THE TELEVISION IN ANY CRITICAL APPLICATION, THE CUSTOMER AND NOT TCL, ITS AFFILIATES, ADRs OR ASPs – ASSUME SOLE AND FULL RESPONSIBILITY FOR SUCH USE. TCL RESERVES THE RIGHT TO REFUSE TO SERVICE ANY TELEVISION USED IN A CRITICAL APPLICATION. TCL, ITS AFFILIATES, ADRs AND ASPs HEREBY DISCLAIM ANY AND ALL LIABILITY, DAMAGES AND CONSEQUENCES ARISING OUT OF THE SERVICE OR REFUSAL TO SERVICE SUCH TELEVISION AND FURTHER DISCLAIM ANY AND ALL LIABILITY, CONSEQUENCES AND DAMAGES THAT MAY ARISE OR RESULT FROM THE USE OF THE TELEVISION IN ANY CRITICAL APPLICATIONS.

### General Provisions

If and to the extent that any provision of this limited warranty should generally be found to be unenforceable, the unenforceable provision shall be severed from the warranty and deemed not to form part of the warranty. The remaining provisions of this warranty shall be and remain valid and enforceable. If and to the extent that any provision of this limited warranty as it relates to any of the Related Parties is found to be invalid or unenforceable in respect of that party (the "Excluded Party"), the Excluded Party shall be deemed to be severed or excluded from the provision, and the provision shall remain valid, enforceable and applicable in respect of the other or remaining Related Parties.

To the extent permitted by law, this limited warranty shall be governed and construed in accordance with the laws of Ontario.

If there is any inconsistency between this limited warranty, on the one hand, and any statement in the packaging of the Television or in any other document enclosed with, or used in the context of the promotion or sale of, the Television, on the other hand, the provisions of this limited warranty shall prevail.

### How to Obtain Warranty Services

If, after following all of the operating instructions in this manual, checked the "Troubleshooting" section, and have visited [www.toshiba.ca/support](http://www.toshiba.ca/support) for additional information, you find that service is needed, please contact TCL Customer Support toll free at 1 800 268-3404.

For at least three (3) years from the date of distribution of the this product, Toshiba will give to anyone who contacts Toshiba Consumer Solutions at (800) 631-3811, for a charge of no more than our cost of physically performing source code distribution, a complete machine-readable copy of the complete corresponding GPL and LGPL source code for the version of the GPL and LGPL code that we distributed to you in this product.

### WMDRM End User Notice

Content owners use Windows Media digital rights management technology (WMDRM) to protect their intellectual property, including copyrights. This device uses WMDRM software to access WMDRM-protected content. If the WMDRM software fails to protect the content, content owners may ask Microsoft to revoke the software's ability to use WMDRM to play or copy protected content. Revocation does not affect unprotected content. When you download licenses for protected content, you agree that Microsoft may include a revocation list with the licenses. Content owners may require you to upgrade WMDRM to access their content. If you decline an upgrade, you will not be able to access content that requires the upgrade.

# Index

|  |                                    |                          |                             |
|--|------------------------------------|--------------------------|-----------------------------|
| <b>A</b>   | LED Indication..... 72             | <b>V</b>                 | V-Chip blocking.....36      |
| Auto Aspect..... 47                                  | Location ..... 28                  | Voice Enhancement.....54 |                             |
| Auto Input..... 31                                   | <b>M</b>                           | <b>W</b>                 | Wallpaper .....69           |
| Auto Tuning ..... 28                                 | Manual Tuning ..... 29             | White Balance .....51    | Wireless Information.....57 |
| AutoView®..... 48                                    | Media Player ..... 64              |                          |                             |
| <b>B</b>   | Movie.....65                       |                          |                             |
| Backlight..... 48                                    | Music.....66                       |                          |                             |
| Backlight Adjustment Pro..... 50                     | Photo.....67                       |                          |                             |
| Base Color Adjustment..... 51                        | MPEG NR.....50                     |                          |                             |
| <b>C</b>   | MTS.....52                         |                          |                             |
| Channel Browser™..... 32                             | MUTE ..... 52                      |                          |                             |
| Channel lock..... 38                                 | <b>N</b>                           |                          |                             |
| Channel Return..... 34                               | NET TV™..... 60                    |                          |                             |
| Channel Tuning Mode ..... 32                         | Network Setup ..... 56             |                          |                             |
| ClearFrame™..... 50                                  | <b>O</b>                           |                          |                             |
| Closed Captions..... 35                              | On Timer ..... 42                  |                          |                             |
| Color Temperature..... 51                            | <b>P</b>                           |                          |                             |
| ColorMaster™ ..... 51                                | Panel Lock ..... 39                |                          |                             |
| <b>D</b>   | PC audio ..... 42                  |                          |                             |
| Daylight Saving Time..... 28                         | PC connection ..... 20             |                          |                             |
| DIGITAL AUDIO OUT..... 18, 53                        | PC settings..... 42                |                          |                             |
| Digital CC Settings ..... 35                         | Picture mode..... 48               |                          |                             |
| DNR ..... 50   | Picture Position ..... 47          |                          |                             |
| DVI connection ..... 16                              | Picture quality ..... 48           |                          |                             |
| DynaLight™ ..... 49                                  | Picture size..... 45               |                          |                             |
| Dynamic Bass Boost ..... 54                          | PIN code ..... 36                  |                          |                             |
| Dynamic Contrast..... 49                             | <b>R</b>                           |                          |                             |
| Dynamic Range Control ..... 53                       | Remote control                     |                          |                             |
| Dynamic Volume (Audyssey<br>Dynamic Volume®)..... 53 | Battery installation..... 22       |                          |                             |
| <b>E</b>   | Buttons..... 23                    |                          |                             |
| Edge Enhancer ..... 49                               | Device code table..... 82          |                          |                             |
| <b>F</b>   | Functional key chart ..... 77      |                          |                             |
| Favorites Browser..... 33                            | Programming ..... 79               |                          |                             |
| Film Stabilization ..... 49                          | Reset TV..... 44                   |                          |                             |
| FREEZE ..... 47                                      | RGB Filter..... 51                 |                          |                             |
| <b>G</b>   | RGB Range ..... 41                 |                          |                             |
| GameTimer®..... 39                                   | <b>S</b>                           |                          |                             |
| <b>H</b>   | SAP ..... 52                       |                          |                             |
| HDMI connection..... 16                              | Shared inputs..... 30              |                          |                             |
| HDMI settings feature..... 41                        | Sleep Timer..... 43                |                          |                             |
| HDMI® CEC Control ..... 39                           | Software keyboard..... 59          |                          |                             |
| <b>I</b>   | Static Gamma ..... 49              |                          |                             |
| Initial Setup..... 24                                | Stereo sound..... 52               |                          |                             |
| Input Lock..... 38                                   | Support information ..... 44       |                          |                             |
| INSTAPORT™ ..... 41                                  | SurfLock™ ..... 34                 |                          |                             |
| <b>L</b>   | <b>T</b>                           |                          |                             |
| Labeling ..... 30                                    | Test Pattern..... 51               |                          |                             |
| Language..... 28                                     | TheaterLock™..... 52               |                          |                             |
|  | TheaterWide® picture size ..... 45 |                          |                             |
|  | Time Zone ..... 28                 |                          |                             |
|  | TV status information ..... 44     |                          |                             |





## **TOSHIBA AMERICA INFORMATION SYSTEMS, INC.**

Corporate Headquarters: 9740 IRVINE BLVD. IRVINE, CA 92618  
VISUAL PRODUCTS SERVICE AND SUPPORT: 1420-B TOSHIBA DRIVE, LEBANON, TN 37087, U.S.A.

## **TOSHIBA OF CANADA LTD.**

HEAD OFFICE: 191 McNABB STREET, MARKHAM, ONTARIO, L3R 8H2, CANADA

MANUFACTURED BY

## **TOSHIBA ELECTROMEX, S.A. DE C.V.**

AutoView, ColorStream, GameTimer and TheaterWide are registered trademarks of Toshiba America Information Systems, Inc.

Channel Browser, ClearFrame, DynaLight, ColorMaster, NET TV, SurfLock and TheaterLock are trademarks of Toshiba America Information Systems, Inc.