

SONY®



Table of
contents

Operation
Search

Menu/Settings
Search

Index

bloggie™

Handbook Mobile HD Snap Camera

MHS-FS1/FS1K/FS2/FS2K

How to use this handbook

Click on a button on the right to jump to the corresponding page.
This is convenient when searching for a function you want to view.



← Search for information by function.

← Search for information by operation.

← Search for information in a listing of menu/setting items.

← Search for information by keyword.

Table of contents

Operation Search

Menu/Settings Search

Index

Marks and notations used in this handbook

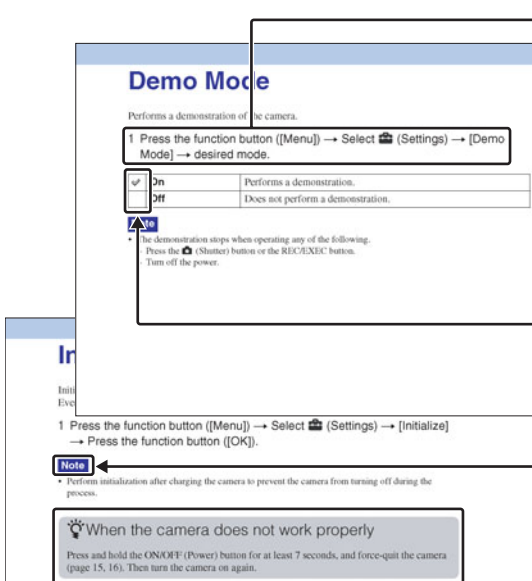

In this handbook, the sequence of operations is shown by arrows (→). Operate the camera in the order indicated. Marks are shown as they appear in the camera's default setting.

The default setting is indicated by ✓.

Indicates cautions and limitations relevant to the correct operation of the camera.

Indicates information that is useful to know.

Notes on using the camera

Internal memory back up

Be sure to make a backup copy to protect your data.

Notes on recording/playback and connection

- Before you start recording, make a trial recording to make sure that the camera is working correctly.
- The camera is neither dust-proof, nor splash-proof, nor water-proof. Read “Precautions” (page 76) before operating the camera.
- Avoid exposing the camera to water. If water enters inside the camera, a malfunction may occur. In some cases, the camera cannot be repaired.
- Do not aim the camera at the sun or other bright light.
- Do not use the camera near a location that generates strong radio waves or emits radiation. Otherwise, the camera may not properly record or play back images.
- Using the camera in sandy or dusty locations may cause malfunctions.
- If moisture condensation occurs, remove it before using the camera (page 76).
- Do not shake or strike the camera. It may cause a malfunction and you may not be able to record images. Furthermore, the recording media may become unusable or image data may be damaged.
- When connecting your camera to another device with a cable, be sure to insert the connector plug in the correct way. Pushing the plug forcibly into the terminal will damage the terminal and may result in a malfunction of your camera.
- Playback of movies other than those shot, edited or composed on this camera is not guaranteed.

On camera's temperature

The camera may get warm due to continuous use, but it is not a malfunction.

On the overheat protection

Depending on the camera and battery temperature, you may be unable to record movies or the power may turn off automatically to protect the camera. A message will be displayed on the LCD screen before the power turns off or you can no longer record movies.

Notes on the battery pack

- The battery pack is built into the camera. Charge the camera before using for the first time.
- You can charge the battery pack even if it is not completely discharged. In addition, even if the battery pack is not fully charged, you can use the partially charged capacity of the battery pack as is.
- For details on the usable battery pack, see page 75.

Notes on the LCD screen and lens

- The LCD screen is manufactured using extremely high-precision technology so over 99.99% of the pixels are operational for effective use. However, some tiny black and/or bright dots (white, red, blue or green) may appear on the LCD screen. These dots are a normal result of the manufacturing process and do not affect the recording.



Black, white, red, blue or green dots

- Exposing the LCD screen or the lens to direct sunlight for long periods may cause malfunctions. Be careful when placing the camera near a window or outdoors.
- Do not press against the LCD screen. The screen may be discolored and that may cause a malfunction.
- Images may trail across on the LCD screen in a cold location. This is not a malfunction.

On image data compatibility

- This camera supports “MP4 format” as movie file format. Therefore, movies recorded by this camera cannot be played on devices that do not support “MP4 format”.
- This camera does not support “AVCHD format” and therefore is not compatible with the playback and recording of movies in “AVCHD format” like a Digital HD Video camera recorder.
- Still images recorded by this camera are compressed/recorded in JPEG format. The file extension is “.JPG”.
- The camera conforms with DCF (Design rule for Camera File system) universal standard established by JEITA (Japan Electronics and Information Technology Industries Association).
- Sony does not guarantee that the camera will play back images recorded or edited with other equipment, or that other equipment will play back images recorded with the camera.

Warning on copyright

Television programs, films, videotapes, and other materials may be copyrighted. Unauthorized recording of such materials may be contrary to the provisions of the copyright laws.

No compensation for damaged content or recording failure

Sony cannot compensate for failure to record or loss or damage of recorded content due to a malfunction of the camera or recording media, etc.

The images used in this handbook

- The images used as examples in this handbook are reproduced images, and are not actual images shot using the camera.
- Design and specifications are subject to change without notice.

Notes on playing back movies on other devices

The camera is compatible with MPEG-4 AVC/H.264 Main Profile. Therefore, you cannot play back images on the camera with the devices which are not compatible with the MPEG-4 AVC/H.264.

On Illustrations

Illustrations used in this handbook are for the MHS-FS2/FS2K, unless noted otherwise.

Life with “Bloggie”

Capture your life

At a party

Record still images at maximum 5M (2592 × 1944) and movies at maximum 1920 × 1080 30p full high-vision (page 50, 52). Also, you can record still images during movie recording (page 32).



During a walk

Take compact “Bloggie” with you anywhere, anytime. Take it out, and record casually.



On a trip

Attach the 360 Video Lens to “Bloggie” and shoot exciting 360-degree panoramic images of the world around you. Enjoy 360-degree panoramic images by playing back with the Bloggie Software pre-loaded on the internal memory (page 37). (MHS-FS1K/FS2K only)

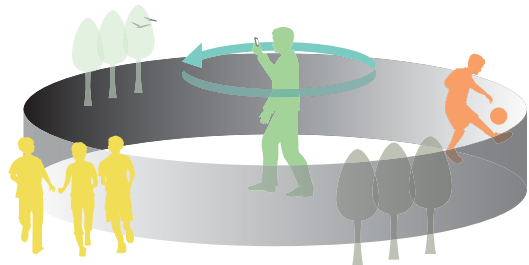

Table of contents

Operation Search

Menu/Settings Search

Index

Share your life

Import and upload captured moments

You can upload images easily and intuitively, using the Bloggie Software pre-loaded on the internal memory (page 25, 49).

You can also choose the images and the sharing site to upload in advance (Share it Later) (page 55).

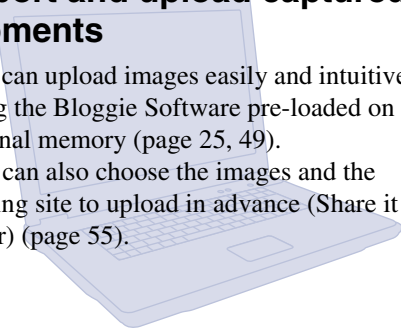

Connect to TV

Connect your “Bloggie” to a TV with an HDMI cable (sold separately), and enjoy images on the big screen (page 65).

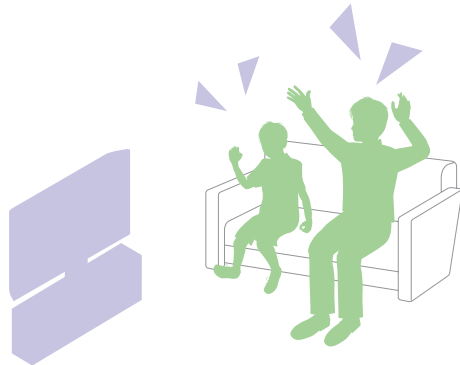
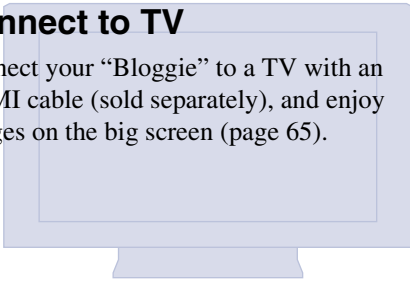

Table of contents

Notes on using the camera

How to use this handbook	2
Notes on using the camera	3
Life with “Blogger”	5
Operation Search	10
About operation buttons of the camera	11
Menu/Settings Search	12
Identifying parts	15
List of icons displayed on the screen	17
How to hold the camera	19

Getting started

Checking the accessories supplied	21
Charging the camera	22
Installing the software	25
Setting the language and clock	28

Shooting

Shooting (Still images)	29
Shooting (Movies)	31
Zoom	33
Light (MHS-FS2/FS2K only)	34
Self-Timer	35
Shooting in mirror mode (Self-portraits) (MHS-FS2/FS2K only)	36
Shooting 360 Video images (MHS-FS1K/FS2K only)	37

Viewing

Viewing.....	40
Playback zoom.....	43
Volume control	44

Computer

Recommended computer environment	45
Using the Bloggie Software.....	47
Importing images to a computer.....	48
Uploading images to a media service	49

Settings

Menu items.....	12
Setting items	13

TV

Viewing images on a TV	65
------------------------------	----

Troubleshooting

Troubleshooting	68
Warning indicators and messages	72

Others

Number of still images and recordable time of movies.....	74
Built-in battery pack.....	75
Precautions	76
Specifications	77

Index

Index 79

Table of contents

Operation Search

Menu/Settings Search

Index

Operation Search

Table of
contents

Operation
Search

Menu/Settings
Search

Index

Shooting still images	Shooting (Still images).....	29
Shooting movies	Shooting (Movies)	31
Changing image size	Photo Size	50
	Movie Size	52
Deleting images	Delete.....	53
	Format	63
Displaying enlarged images	Playback zoom.....	43
Changing clock settings	Date & Time Setting.....	64
Initializing settings	Initialize.....	60
Viewing on TVs	Connecting with an HDMI cable (sold separately)	65
Marking the images to upload	Share it Later	55
Shooting a 360-degree view (MHS-FS1K/FS2K only)	360 Video Lens	37

About operation buttons of the camera

Multi-selector buttons

You can use the multi-selector buttons (▲/▼/◀/▶) to activate functions such as zooming when shooting or playing back images.

The function that is allocated to each multi-selector button is displayed on the LCD screen of the camera. The display changes according to how the camera is held (vertically or horizontally).

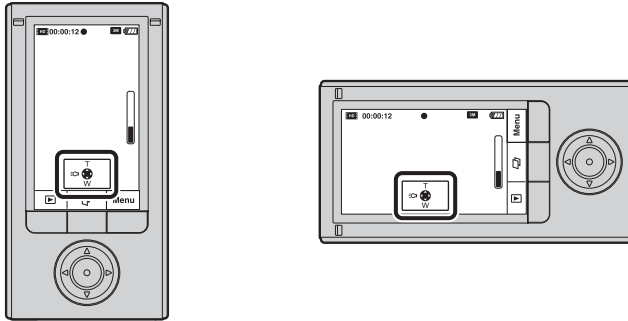

Function buttons

Button function varies depending on when shooting or playing back images. The function that is allocated to a function button is displayed on the LCD screen of the camera.

As illustrated below, press the A' function button when you want to use the A function [▶], or press the B' function button for the B function [Menu].

In this handbook, the phrase "Press the function button ([Menu])" is used to explain a [Menu] function.

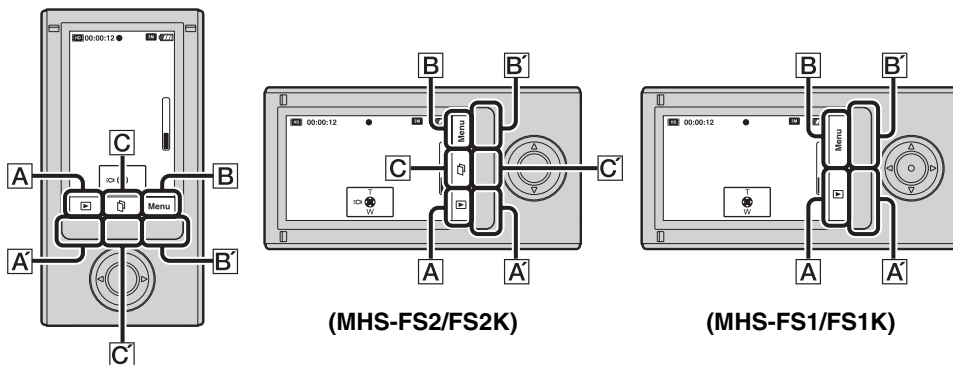

Notes

- Function button C' is for the MHS-FS2/FS2K only. In this handbook, it is named and written as Front display button.
- Illustrations used in this handbook are for the MHS-FS2/FS2K, unless noted otherwise.

Menu/Settings Search

Menu items

In the table below, ✓ indicates settings that can be changed, while – indicates settings that cannot be changed.

Click an item to jump to the corresponding page.

Items	Shooting mode	Playback mode
Photo Size	✓	–
Movie Size	✓	–
Delete	–	✓
Protect	–	✓
Share it Later	–	✓

1 Press the ON/OFF (Power) button.

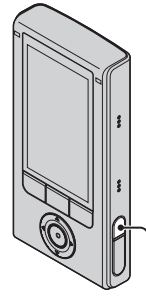

ON/OFF (Power) button

2 Press the function button ([Menu]) to display the menu screen.

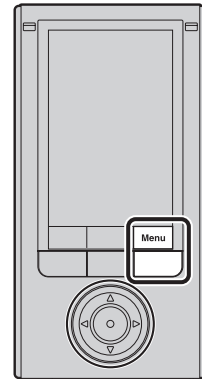

- 3 Select the desired menu item by using ▲/▼ to set.

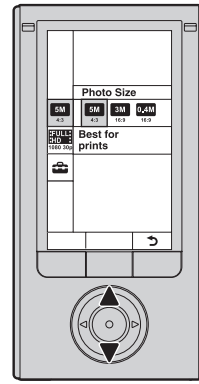

- 4 Select the desired setting item by using ◀/▶, then press the MOVIE/ENTER button.

Press the function button (↻) to exit the menu screen.

Setting items

In the table below, ✓ indicates settings that can be changed, while – indicates settings that cannot be changed.

Click an item to jump to the corresponding page.

Items	Shooting mode	Playback mode
Flicker Reduction	✓	–
Beep	✓	✓
Language Setting	✓	✓
Demo Mode	✓	✓
Initialize	✓	✓
LUN Setting	✓	✓
HDMI Output	✓	✓
Format	✓	✓
Date & Time Setting	✓	✓

- 1 Press the ON/OFF (Power) button.
- 2 Press the function button ([Menu]) to display the menu screen.
- 3 Select  (Settings) by using ▲/▼, then press the MOVIE/ENTER button.
- 4 Select the desired setting item by using ▲/▼, then press the MOVIE/ENTER button.

The selected item will be highlighted.

Press the function button (↻) to exit the setting screen.

Press ◀ repeatedly to go back to the menu screen from the setting screen.



To cancel changing settings



Select [Cancel], then press the MOVIE/ENTER button. If [Cancel] does not appear on the screen, directly set back to the previous setting.

- Selected settings are retained even if the power is turned off.

Identifying parts

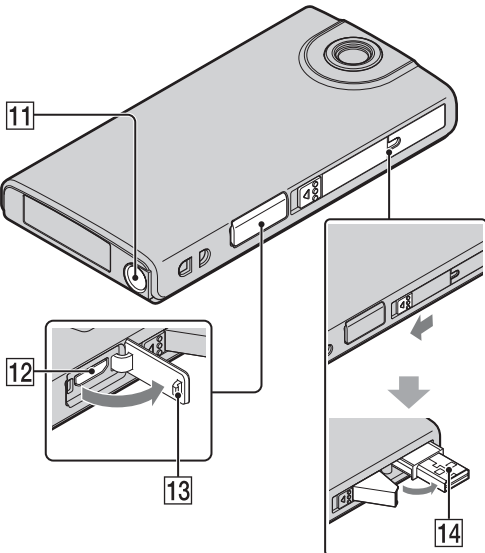
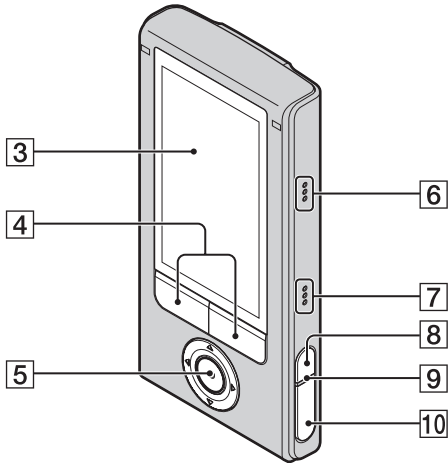
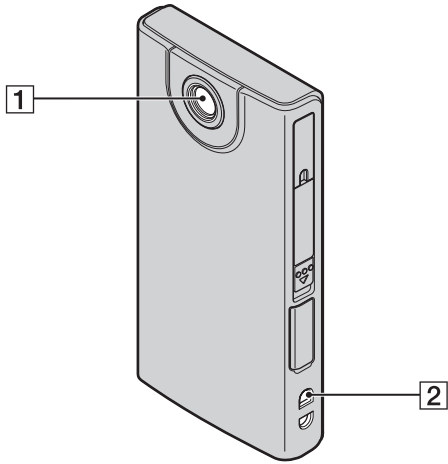
MHS-FS1/FS1K



- 1 Lens
- 2 Hook for wrist strap
- 3 LCD screen
- 4 Function buttons
- 5 MOVIE/ENTER button
Multi-selector buttons (▲/▼/◀/▶)
- 6 Microphone
- 7 Speaker
- 8 ON/OFF (Power) button
 - Press and hold the ON/OFF (Power) button for at least 7 seconds to force-quit the camera.
- 9 Charge lamp
- 10  (Shutter) button
- 11 Tripod receptacle
 - Do not hold the camera when attaching the tripod.
- 12 HDMI OUT jack (65)
- 13 Jack cover
- 14  (USB) jack

Identifying parts

MHS-FS2/FS2K

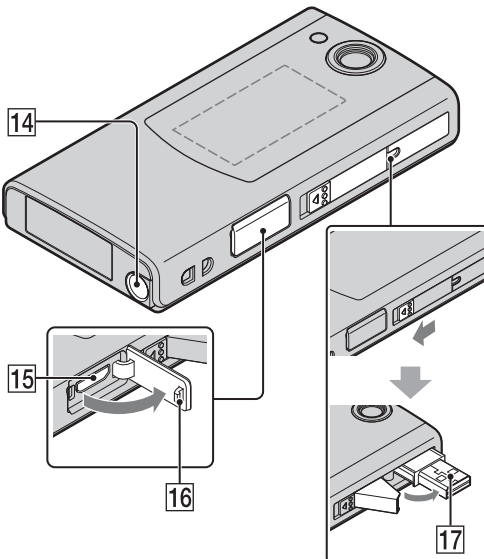
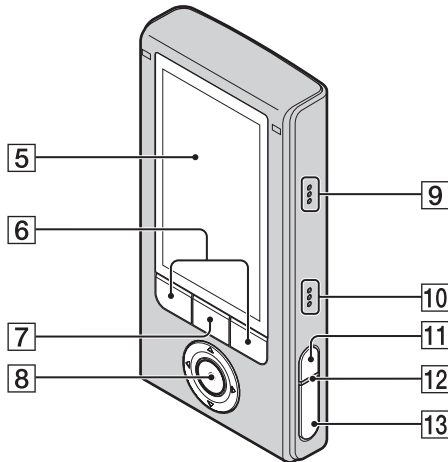
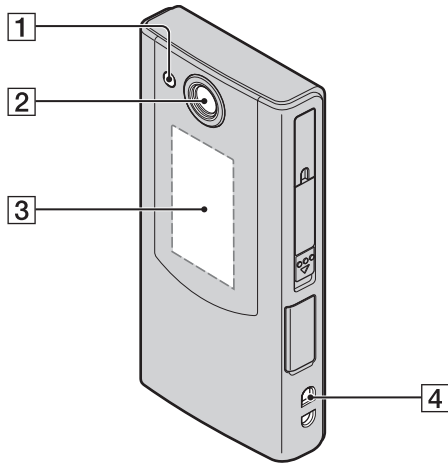

- 1 Light
- 2 Lens
- 3 Front display
- 4 Hook for wrist strap
- 5 Main display
- 6 Function buttons
- 7 Front display button
- 8 MOVIE/ENTER button
Multi-selector buttons (▲▼◀▶)
- 9 Microphone
- 10 Speaker
- 11 ON/OFF (Power) button
 - Press and hold the ON/OFF (Power) button for at least 7 seconds to force-quit the camera.
- 12 Charge lamp
- 13 📷 (Shutter) button
- 14 Tripod receptacle
 - Do not hold the camera when attaching the tripod.
- 15 HDMI OUT jack (65)
- 16 Jack cover
- 17 🔄 (USB) jack

List of icons displayed on the screen

Icons are displayed on the screen to indicate the camera status.

When in standby for shooting

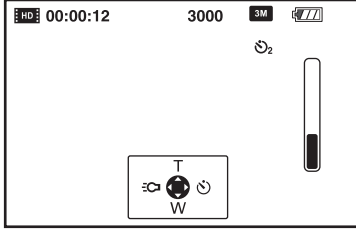

When shooting movies

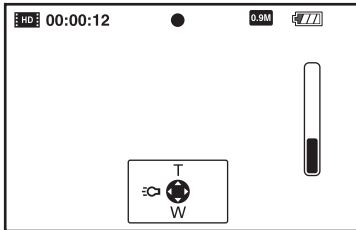

When playing back

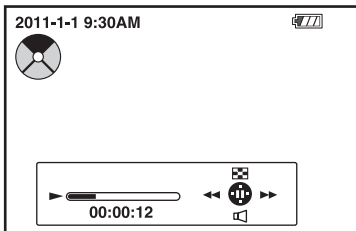

Icons

Display	Indication
	Battery remaining
	Low battery warning
	Photo Size (aspect ratio/resolution)
	Movie Size (resolution vertical shooting/frame rate)
	Self-timer
3000	Number of recordable still images
	AE/AF lock
00:00:12	Recordable time
0:12	Recording time (m:s)
2011-1-1 9:30 AM	Recorded date/time of the playback image
	During movie recording
	Share it Later
	Protect
	Overheating warning
00:00:12	Counter
	Zoom scaling
	Light
	Index
	Adjusting volume
	Portion of 360 Video image during playback

Notes

- Indicators and their positions are approximate and differ from what you actually see.
- The screen display shifts both horizontally and vertically depending on the camera aspect.
- The screen display disappears automatically after about 5 seconds.

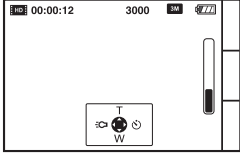

How to hold the camera

- Be careful not to block the lens or microphone with your finger when shooting.

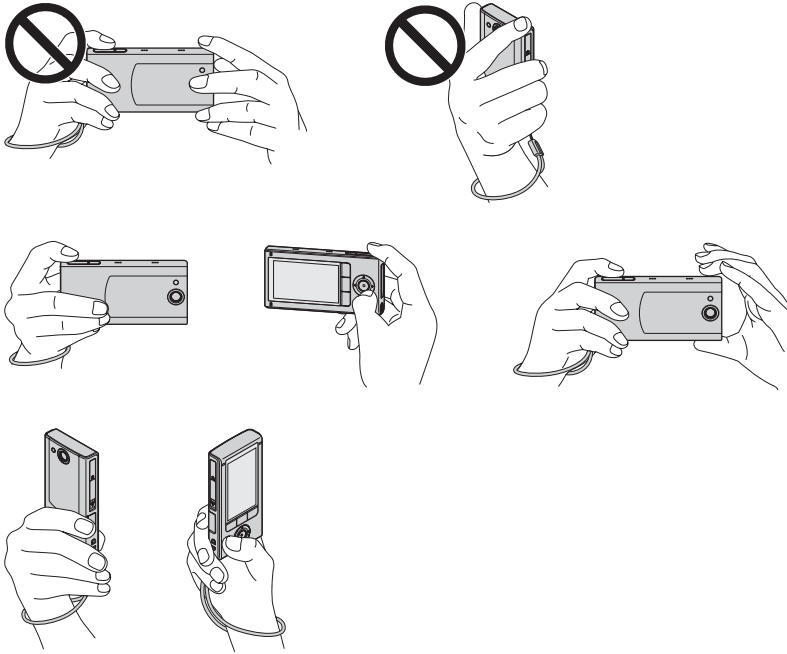

- Do not hold the USB jack or HDMI OUT jack cover. Also, do not hold the 360 Video Lens when it is attached to the camera.

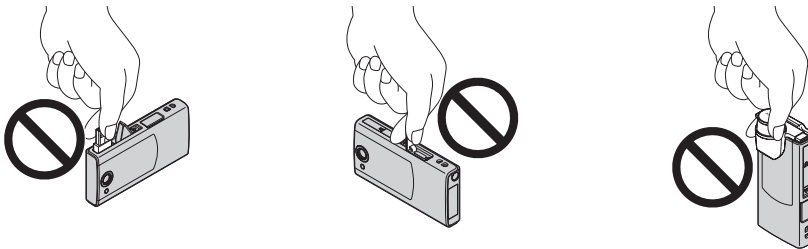

- Attach the strap and place your hand through its loop to prevent the camera from damage by being dropped.

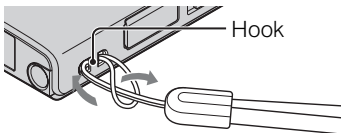



Holding the camera vertically when you shoot movies

Portrait images are recorded. Black bands appear on the left and right of the screen during playback on TV or computer. This is useful when shooting portrait objects.

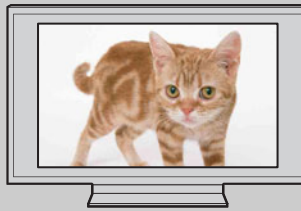
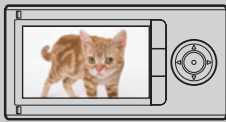
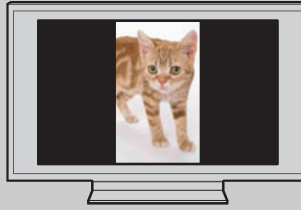

Checking the accessories supplied

- USB connection support cable (1)

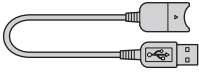

Use this if the USB jack of the camera cannot be connected to the computer (page 22).

- 360 Video Lens VCL-BPP3 (1) / 360 Video Lens case (1)
(only for MHS-FS1K/FS2K)



- Wrist strap (1)
- Software (page 25, 47)
The following contents are included on the internal memory of this camera.
 - Bloggie Software (application software)
 - Bloggie Handbook (this manual)
- Instruction Manual (1)
- Important Notice (1)

Charging the camera

The camera's battery is continuously charged whenever the camera is connected to a running computer.

- 1 Press the ON/OFF (Power) button to turn off the camera.

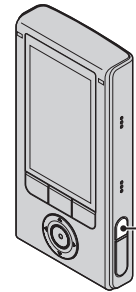

ON/OFF (Power) button

- 2 Slide the slide lever at the side of the camera.
The USB jack comes out as shown in the illustration.

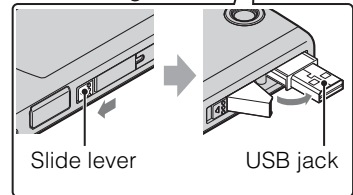
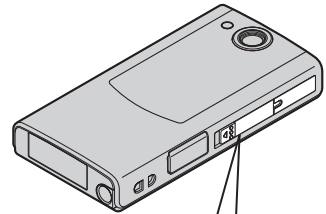

- 3 Connect the camera to the computer that is turned on.

The charge lamp lights up in orange, and charging starts. When the charge lamp turns off, charging is finished.

- The charge lamp may turn off when the temperature is outside of the recommended operating temperature (10°C to 30°C (50°F to 86°F)).

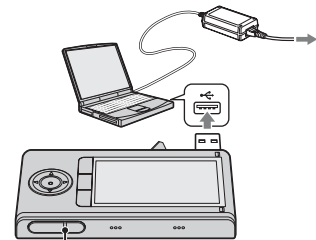

Charge lamp

4 When charging is finished, disconnect the USB connection between the camera and computer (page 23).

Install Bloggie Software (pre-loaded on the internal memory) after completing the procedure above.

Notes

- While the camera is connected to a computer, you cannot operate the camera. Be sure to disconnect the camera before operation.
- Do not apply force to the camera, when you connect the camera to a computer. This may cause damage to the camera or the computer.
- When you connect the camera to a notebook computer that is not connected to an AC power source, the battery of the notebook computer may be depleted rapidly. Do not leave the camera connected to the computer for a long time.
- Charging the battery or the connection with customized or hand-built computers is not guaranteed. Depending on the type of the USB device used, charging may not function properly.
- If you do not intend to use the camera for an extended period, charge the camera once every 6 to 12 months to maintain battery performance.

Disconnecting the USB connection

Perform the procedures from step 1 to 3 below before:

- Disconnecting the USB connection support cable.
- Turning off the camera.

- 1 Double-click the disconnect icon on the tasktray.
- 2 Click  (USB Mass Storage Device) → [Stop].
- 3 Confirm the device on the confirmation window, then click [OK].

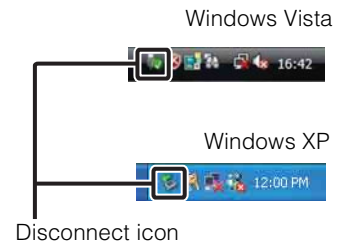

Note

- Drag and drop the drive icon to the "Trash" icon beforehand when you use a Macintosh computer, and the camera is disconnected from the computer.

To retract the USB jack

Push the USB jack back in the direction of the arrow until it clicks.

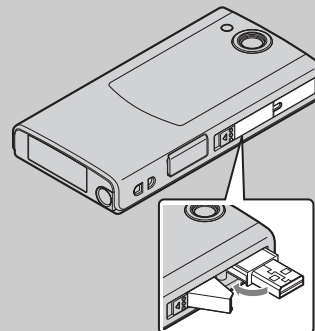

💡 How long does it take to charge the camera?

Charging time

Full charge time
Approx. 200 min.

- Time required to charge a fully depleted battery at a temperature of 25°C (77°F). Charging may take longer under certain circumstances or conditions.

💡 How long can I record or play back images?

Standard battery life

Recording time* ¹	
Continuous recording time* ²	Approx. 120 min.
Typical recording time* ³	Approx. 70 min.

Playback time
Approx. 150 min.

- For MHS-FS2/FS2K, playback or recording time is the time when the Front display is off.

*¹ Recording time is the time when you set movie size to [1280×720 30p].

*² Continuous recording time shows the approximate time available of a fully charged battery pack. Continuous recording of movies is possible for approximately 29 minutes. Also, recording stops automatically to prevent the file size from exceeding 2 GB.

*³ Typical recording time shows the approximate time available of a fully charged battery pack when you repeatedly execute operations, such as setting to shooting mode, turning on/off the power, or zooming.

💡 Checking the remaining battery charge

A remaining charge indicator appears on the upper right of the LCD screen.

High      Low



- The displayed battery remaining indicator may not be correct under certain circumstances.
- If the camera is running on battery power and you do not operate the camera for about 5 minutes, the camera turns off automatically to prevent wearing down the battery (Auto power off function).
- The Language/Clock Setting screen appears when the camera is turned on for the first time (page 28).
- It takes about one minute until the correct battery remaining indicator appears.

Installing the software

You can do the following using the Bloggie Software (pre-loaded on the internal memory).

- Import images shot with the camera to a computer, and play back.
- Upload images to a network service.

1 Press the ON/OFF (Power) button to turn on the camera.

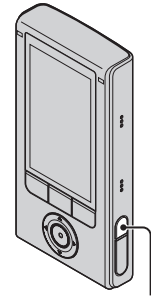

ON/OFF (Power) button

2 Slide the slide lever at the side of the camera.

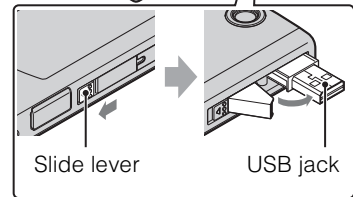
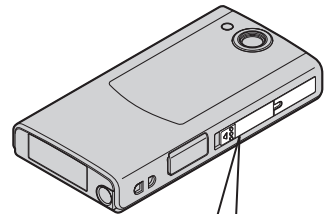

3 Connect the camera to the computer that is turned on.

When the USB connection is completed, the Mass Storage screen appears on the LCD screen of the camera.

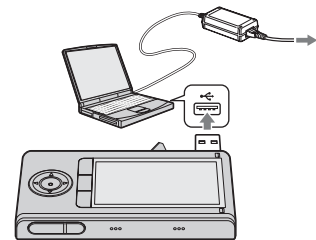

4 Activate the installer.

Windows 7

- 1 Click [Open folder to view files] on the AutoPlay screen.



- 2 Double-click "Setup_Bloggie_Windows.exe" in the folder.

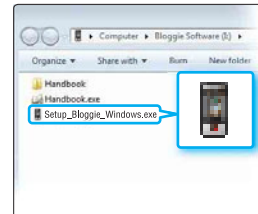

Windows Vista/Windows XP

- 1 Click [Setup Bloggie Software] on the AutoPlay screen.



- If the AutoPlay screen does not appear, click [Start] → [Computer] (in Windows XP, [My Computer]), then double-click [Bloggie Software] → "Setup_Bloggie_Windows.exe."

Macintosh

- 1 Double click the [BLOGGIE_SW] icon.



- 2 Double click [Setup Bloggie Mac.dmg].

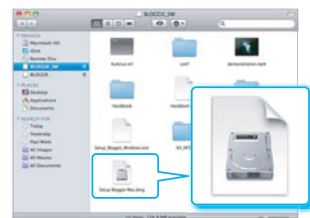

③ Double click the “Bloggie” icon.



5 Click [Install], and follow the instructions on the screen to complete the installation.



6 Disconnect the USB connection between the camera and computer after the installation is completed (page 23).

- For details on the Bloggie Software, see page 47.

Notes

- If you turn on or restart the computer while the camera is connected to the computer, the camera may malfunction. In this case, press and hold the ON/OFF (Power) button for at least 7 seconds, and force-quit the camera. Disconnect the camera from the computer before you turn on or restart the computer.
- Even if you delete files such as “Setup_Bloggie_Windows.exe”/“Setup Bloggie Mac.dmg” in the [Bloggie Software]/[BLOGGIE_SW] folder, the recording capacity of the camera does not increase.

Setting the language and clock

1 Press the ON/OFF (Power) button.

The camera is turned on.

The demonstration movie plays back when you turn on the camera for the first time.

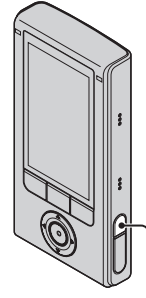

ON/OFF (Power)
button

2 Select the desired language by using ▲/▼/◀/▶, then press the function button ([OK]).

3 Set the clock by using ▲/▼/◀/▶.

- ① Select the desired date display format by using ▲/▼, then press the MOVIE/ENTER button.
- ② Select the year, month, or day by using ◀/▶ and numeric value by using ▲/▼, then press the MOVIE/ENTER button.
- ③ Press the function button ([OK]).

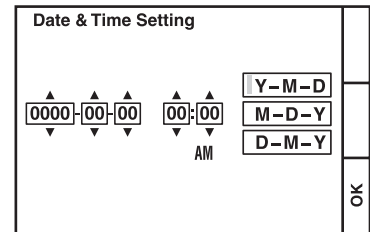

To set the date and time again

Press the function button ([Menu]) → Select  (Settings) → [Date & Time Setting] (page 64).

Shooting (Still images)

1 Press the ON/OFF (Power) button.

ON/OFF (Power) button

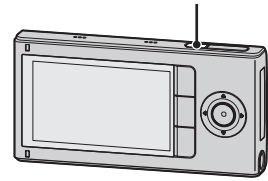

2 Compose the shot.

Be sure not to place fingers on the lens.
Press ▲ to zoom in or ▼ to zoom out.

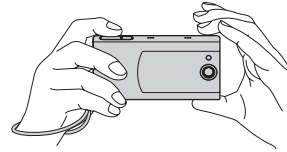

3 Press the  (Shutter) button halfway down.

When the image is in focus, a beep sounds and the ● indicator (AE/AF lock) lights on the top of the display.

AE/AF lock indicator

 (Shutter) button

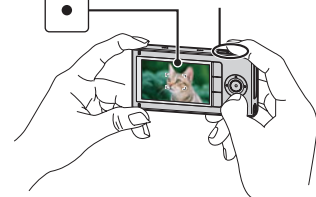

4 Press the  (Shutter) button fully down.



If you shoot a still image of a subject that is difficult to focus on

- The shortest shooting distance is approximately 10 cm (4 inches).
- If the camera cannot focus on a subject automatically, the AE/AF lock indicator changes to slow flashing and the beep does not sound. Recompose the shot.
- Focusing may be difficult in the following situations:
 - It is dark and the subject is distant.
 - The contrast between the subject and the background is poor.
 - The subject is seen through glass.
 - The subject is moving quickly.
 - There is reflective light or shiny surfaces.
 - The subject is flashing.
 - The subject is backlit.



When shooting portrait

- When the camera detects faces, the white frames appear, and the focus and exposure are adjusted to the faces automatically.
- The frames turn green when the faces are in focus by pressing the  (Shutter) button half way down.
- The camera may not detect faces depending on the shooting condition.

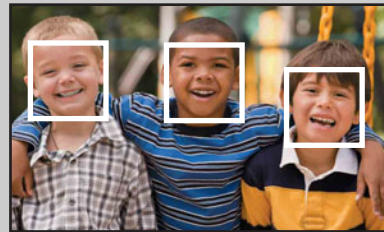

Shooting (Movies)

1 Press the ON/OFF (Power) button.

ON/OFF (Power) button

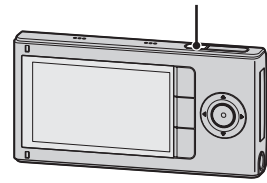

2 Compose the shot.

Be sure not to place fingers on the lens.
Press ▲ to zoom in or ▼ to zoom out.

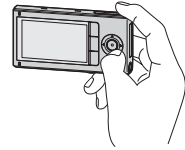

3 Press the MOVIE/ENTER button.

Press the MOVIE/ENTER button again to finish shooting the movie.

MOVIE/ENTER button



Notes

- Continuous recording is possible for approximately 29 minutes.
- The maximum size of a single movie file is approximately 2 GB. Recording stops before 29 minutes if the file size reaches approximately 2 GB during movie recording.

To shoot still images during movie recording

- Press the  (Shutter) button fully down during movie recording.
- The recorded still image appears small on the LCD screen of the camera.

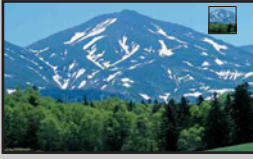

- The still image sizes are as follows, depending on the movie size.
 - 1920 × 1080 30p: (1920 × 1080)
 - 1280 × 720 30p/60p: (1280 × 720)
 - 480 × 270 30p: (480 × 270)

About the HD (High Definition) recording method of this camera

For MPEG-4 AVC/H.264, the camera supports high definition images with an effective total number of scanning lines of 1080 or 720. The number of recorded image pixel is 1920 × 1080 or 1280 × 720, approximately 30 or 60 frames per second, and the image is recorded in progressive mode.

- MPEG: Moving Picture Experts Group
- AVC: Advanced Video Codec

MPEG-4 AVC/H.264 is a standard of video camera, which uses highly efficient image compression encoding technology to record HD (high definition) images. Compared with the existing image compression encoding technology, MPEG-4 AVC/H.264 is able to compress images even more effectively.

Zoom

You can enlarge the image when shooting. The camera's zoom function can enlarge images up to 4 times.

1 Press and hold ▲ or ▼.

Press and hold ▲ to zoom in or ▼ to zoom out.

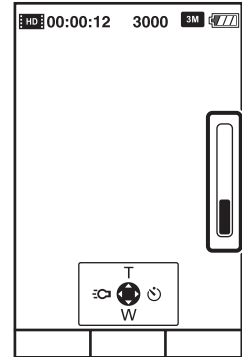

Notes

- Only Digital zoom is available with this camera.
- You may not be able to zoom in or out images smoothly when using zoom function.
- Image quality decreases as the images are digitally processed.

Light (MHS-FS2/FS2K only)

You can shoot with the light of the camera turned on.

1 Press ◀ on the shooting screen.

Press ◀ again to turn off the light.

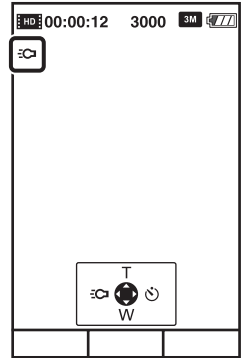

Notes

- You can only use the light in shooting mode. Note that you cannot use it when the 360 Video Lens is attached to the camera.
- The camera emits very bright light. Do not aim directly at eyes at close range.
- Battery power wears down faster when the light is turned on.

Self-Timer

1 Press **▶** on the shooting standby screen.

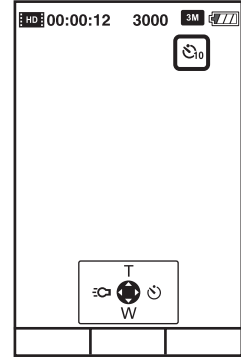

2 Select the desired mode by using **▶**.

✓	OFF (Off)	Does not use the self-timer.
	2 (2sec)	Sets the 2-second delay self-timer. When you press the (Shutter) button or the MOVIE/ENTER button, a self-timer icon flashes, and after rapid beep sounds are heard, the camera will shoot.
	10 (10sec)	Sets the 10-second delay self-timer. When you press the (Shutter) button or the MOVIE/ENTER button, a self-timer icon flashes, and after rapid beep sounds are heard, the camera will shoot.

When using the Front display (MHS-FS2/FS2K only)

By displaying the Front display during self-timer mode, you can shoot with the countdown timer on the Front display (page 36).

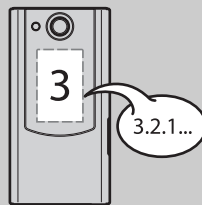

Shooting in mirror mode (Self-portraits) (MHS-FS2/FS2K only)

You can shoot self-portraits in mirror mode by displaying the image on the Front display. It enables you to confirm the desired angles or check faces.

1 Press the Front display button (📺).

Each press switches to ON → OFF.

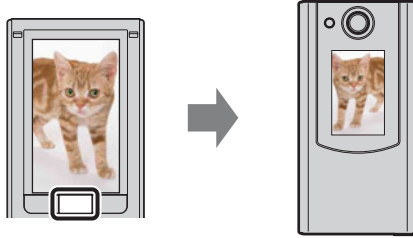

💡 Images on the Front display

- A mirror-reversed image of the subject appears on the Front display during mirror mode, but it will be recorded normally.
- You can shoot with the countdown timer on the Front display during self-timer mode (page 35).
- The demo mode demonstration always plays back on the Front display.
- By displaying the Front display during playback, you can share the playback images or movies with a person face-to-face. Each press switches to OFF → ON during playback (page 41).

Shooting 360 Video images (MHS-FS1K/FS2K only)

Table of contents

Operation Search

Menu/Settings Search

Index

By attaching the supplied 360 Video Lens to the camera, you can shoot 360-degree images of the area around the camera.

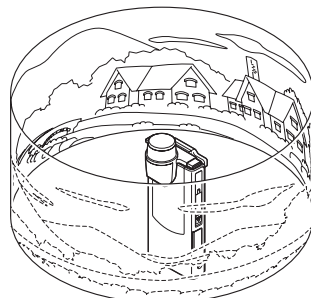

1 Take out the 360 Video Lens from its case.

- Press and hold the Δ mark of the 360 Video Lens case to open it.

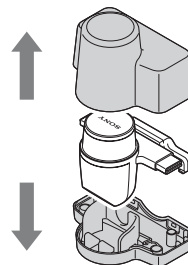

2 Press the ON/OFF (Power) button.

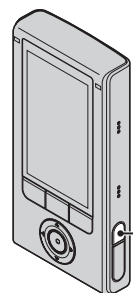

ON/OFF (Power) button

3 Press and hold both sides of the 360 Video Lens (①), then attach it to the camera in the direction (②).

- Attach the hooks of the 360 Video Lens to the attaching parts of the camera, as shown in the illustration.
- The camera shifts to the “360 Video” mode automatically, and the ring-shaped image appears on the LCD screen.

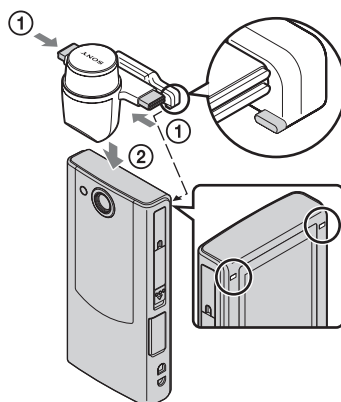

4 Start shooting (page 29, 31).

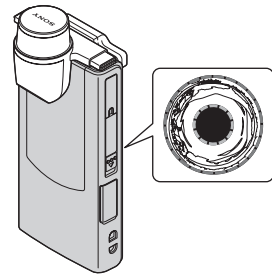

Notes

- Do not attach or remove the 360 Video Lens during shooting.
- The still image size is fixed to 3M (16:9), and the movie size is fixed to 1920 × 1080 30p.
- When you attach the 360 Video Lens to the camera, you cannot operate zooming or settings.
- Do not hold the camera by the 360 Video Lens only.

To place the camera vertically

Attach the bottom part of the 360 Video Lens case to the bottom of the camera.

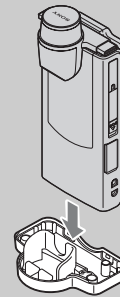

To remove the 360 Video Lens

Press and hold both sides of the 360 Video Lens (①), then pull it in the opposite direction of when attaching (②).

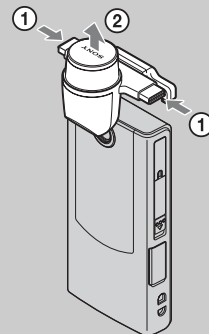

Viewing 360 Video images

You can play back 360 Video images on the computer using the Bloggie Software. For details on the installation of the Bloggie Software, see page 25.

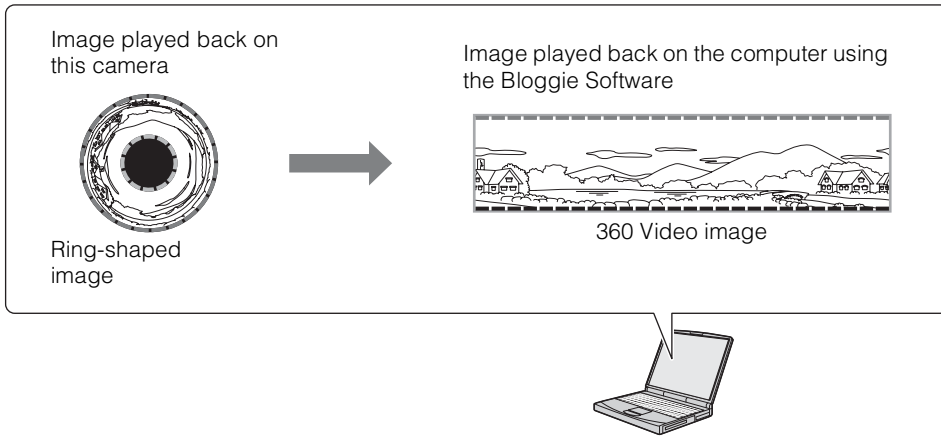

Notes

- You can play back each 1/4 portion of the 360-degree panoramic view image, scene by scene, on the camera in 360 playback mode (page 42).
- When playing back converted 360 Video images, the resolution of the played back images is lower than that of normal images.

Viewing

- 1 Press the function button (▶) to switch to playback mode.
The index screen appears.

- 2 Select an image by using ▲/▼/◀/▶, then press the MOVIE/ENTER button.

A single movie plays back when a movie is selected.
The movie will be paused if you press the MOVIE/ENTER button.

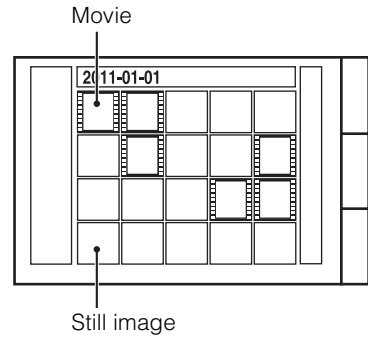

💡 To show the previous/next images

Press ◀/▶.

Press ◀/▶ for the movies while playback is paused.

💡 Fast forward/Fast rewind the movie

Press ◀/▶ during playback of the movie.

💡 To go back to the shooting screen

Do one of the following:

- Press the function button (📷).

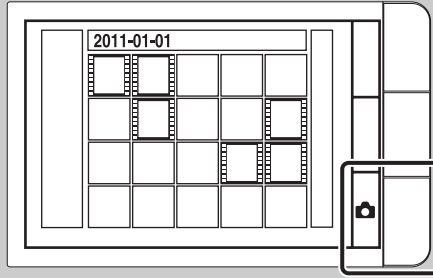

- Press the 📷 (Shutter) button.

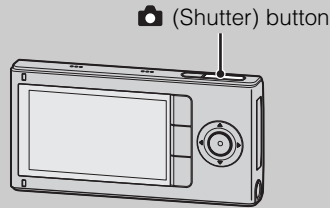

💡 To go back to the index screen

Press ▲ during playback of the still images or movies.

💡 Playing back with the Front display (MHS-FS2/FS2K only)

By displaying the Front display during playback, you can share the playback images or movies with a person face-to-face.

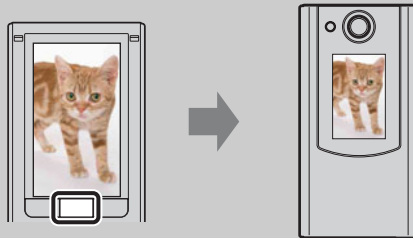

💡 Viewing the 360 Video images (MHS-FS1K/FS2K only)

You can play back each 1/4 portion of the 360-degree panoramic view image, scene by scene, on the camera in 360 playback mode.

In playback mode, select an image that was shot with the 360 Video Lens.

While the 360 Video image is paused, press ▼ to set 360 playback mode, then press the MOVIE/ENTER button to play back.

Press the function button (➡) or (⬅) to play back another portion of the 360 Video image.

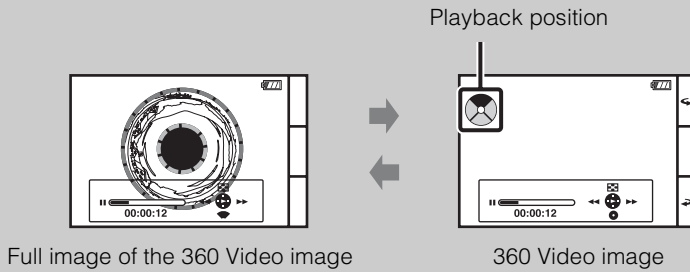

Playback zoom

Enlarges the played back still images.

- 1 Press the function button (▶) to switch to playback mode.
- 2 Select a still image, then press the MOVIE/ENTER button.
- 3 Press the MOVIE/ENTER button.
- 4 Adjust the magnification and the part to enlarge.

The image can be enlarged up to 8 times from its original size by pressing the function button (🔍). Press ▲/▼/◀/▶ to change the part to enlarge. Press the MOVIE/ENTER button to cancel playback zoom.



Shows the displayed area of the whole image

Note

- You cannot operate playback zoom when an HDMI cable (sold separately) is connected.

Volume control

You can adjust the volume for playback movies.

- 1 Press the function button (▶) to switch to playback mode.
- 2 Select a movie, then press the MOVIE/ENTER button.
- 3 Press ▼.
- 4 Press ▶ to increase or ◀ to decrease the volume.



Recommended computer environment

Windows

The following computer environment is recommended when using the Bloggie Software, and importing images via a USB connection.

OS (pre-installed)	Microsoft Windows XP* ¹ SP3/Windows Vista* ² SP1/Windows 7
Others	CPU: Intel Core Duo 1.66 GHz or faster, Intel Core 2 Duo 1.20 GHz or faster Memory: 1 GB or more Hard Disk: Disk space required for installation: approximately 200 MB Display: 1,024 × 768 dots or more

*¹ Windows XP 64-bit editions and Starter (Edition) are not supported.

*² Starter (Edition) is not supported.

Macintosh

The following computer environment is recommended when using the Bloggie Software or importing images via a USB connection.

OS (pre-installed)	USB Connection: Mac OS X (v10.3 to v10.6) The Bloggie Software: Mac OS X (v10.5 to v10.6)
Others	CPU: Intel Core 2 Duo 1.6 GHz or faster (PowerPC is not supported.) Memory: 1 GB or more Application: QuickTime 7 (The latest version is recommended.)

Notes

- Operation is not assured in an environment based on an upgrade of the operating systems described above or in a multi-boot environment.
- If you connect two or more USB devices to a single computer at the same time, some devices, including the camera, may not operate, depending on the types of USB devices you are using.
- Connecting the camera using a USB interface that is compatible with Hi-Speed USB (USB 2.0 compliant) allows advanced transfer (high speed transfer), as the camera is compatible with Hi-Speed USB (USB 2.0 compliant).
- When your computer resumes activity from suspend or sleep mode, communication between the camera and your computer may not recover at the same time.

Note on playback of movie files (MPEG-4 AVC/H.264)

To play back and edit movie files (MPEG-4 AVC/H.264) recorded by the camera on your computer, you need to install the software compatible with MPEG-4 AVC/H.264 or the Bloggie Software.

- Even in a PC environment where operations are guaranteed, images may not play back smoothly due to dropped frames, etc. Note that the imported image itself is not affected.
- If you are using a notebook PC, be sure to use the PC with the AC adaptor plugged in. Sometimes normal operations are not possible due to the power savings function of the PC.

Note

- Operations are not guaranteed, even on computers fulfilling the above system requirements. For example, other open or background applications currently running may limit product performance.

Using the Bloggie Software



Activating

- 1 Double-click the Bloggie Software (pre-loaded on the internal memory) shortcut icon on the desktop.

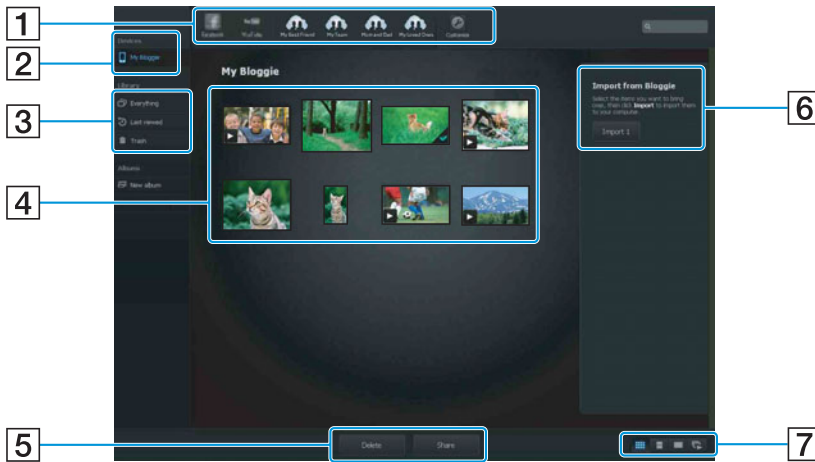

On-screen items



- 1 Sharing site: Drag and drop the thumbnail.
 - 2 Displays the images in the “Bloggie.”
 - 3 Displays imported images in the computer.
 - 4 Thumbnails: Double-click to play.  (movie),  (imported)
 - Press and hold the Ctrl key (for Windows)/command key (for Macintosh) for multiple selections.
 - 5 Creates an album/Deletes images/Shares images
 - 6 Imports images from the “Bloggie.”
 - 7 Switches the screen display.
- The actual screen items or layout may differ depending on the software version.

Importing images to a computer

To connect the camera to your computer, see page 45.

Windows

When using the Bloggie Software

See page 47.

When not using the Bloggie Software

When the AutoPlay Wizard appears after making a USB connection between the camera and a computer, click [Open folder to view files] → [OK] → [DCIM] or [MP_ROOT] → copy the desired images to the computer.

Macintosh

When using the Bloggie Software

See page 47.

When not using the Bloggie Software

- ① Connect the camera to your Macintosh computer first. Double-click the newly recognized [BLOGGIE] icon → [DCIM] or [MP_ROOT] → the folder where the images you want to import are stored.
- ② Drag and drop the image files to the hard disk icon.
The image files are copied to the hard disk.
- ③ Double-click the hard disk icon → the desired image file in the folder containing the copied files.
The image is displayed.

Uploading images to a media service

- 1 Choose images and the sharing site to upload with the camera in advance (page 55).
- 2 Connect the camera to a computer in which the Bloggie Software (pre-loaded on the internal memory) is already installed.
Bloggie Software starts automatically and the confirmation screen for uploading images appears.

Notes

- Set [LUN Setting] to [Multi].
- When uploading images over the Internet, the cache may remain in the computer being used depending on the service provider. This is also true when the camera is used for this purpose.

Notes on Bloggie Software (pre-loaded on the internal memory)





In order to use Bloggie Software to enjoy the benefits of the image uploading service or other services (the “services”) provided by these and other websites, you must consent to the following.

- Some websites require registration procedures and/or fees to use their services. In using such services, you must comply with the terms and conditions established by the websites concerned.
- Services may be terminated or changed in accordance with the convenience of the website operators. Sony will not be held responsible for any trouble occurring between the users and third parties or any inconvenience caused to users relating to the utilization of the services inclusive of the termination of or changes to such services.
- To view a website, you will be redirected to it by the Sony server. There may be times when you cannot access the website because of server maintenance or for other reasons.
- If the operation of the Sony server is to be terminated, you will be notified of the termination ahead of time on Sony’s website, etc.
- The URLs to which you are redirected by the Sony server and other information may be recorded for the purposes of improving Sony’s future products and services. However, no personal data will be recorded on such occasions.

Photo Size

The photo size determines the size of the image file that is recorded when you take an image. The larger the photo size, the more detail will be reproduced when the image is printed on large-format paper. The smaller the photo size, the more images can be recorded.

- 1 Press the function button ([Menu]) to display the menu screen.
- 2 Select [Photo Size] by using ▲/▼ and the desired size by using ◀/▶. Then press the MOVIE/ENTER button to decide.

	Photo Size	Usage guidelines	No. of images	Printing
	5M (2592×1944) 4:3	Suitable for prints	Less 	Fine 
✓	3M (2356×1324) 16:9	Suitable for playback on a computer	↕	↕
	0.4M (854×480) 16:9	Suitable for faster WEB upload	More 	Rough 

Note

- When you print still images recorded with 16:9 aspect ratio, both edges may be cut off.

 When you select **5M (2592 × 1944)**

The aspect ratio switches to 4:3 when shooting images.



💡 On “image quality” and “image size”

A digital image is made up of a collection of small dots called pixels. If it contains a large number of pixels, the image becomes large, it takes up more memory, and the image is displayed in fine detail. “Image size” is shown by the number of pixels. Although you cannot see the differences on the screen of the camera, the fine detail and data processing time differ when the image is printed or displayed on a computer screen.

Description of the pixels and the image size

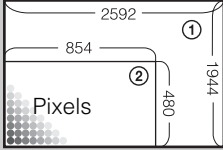

- ① Image size: 5M
2,592 pixels × 1,944 pixels = 5,038,848 pixels
- ② Image size: 0.4M
854 pixels × 480 pixels = 409,920 pixels

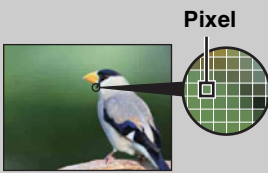

Pixel



Many pixels

(Fine image quality and large file size)



Few pixels





(Rough image quality but small file size)

Movie Size

The larger the movie size, the higher the movie quality.

The movies shot with the camera will be recorded in MPEG-4 AVC/H.264 Main Profile, approximately 30 or 60 frames per second, Progressive, AAC LC, "MP4 format".

- 1 Press the function button ([Menu]) to display the menu screen.
- 2 Select [Movie Size] by using ▲/▼ and the desired size by using ◀/▶. Then press the MOVIE/ENTER button to decide.

	Movie Size	Usage guidelines
	 (1920×1080 30p) 1080 30p	Suitable for playback on a full high definition TV
	 (1280×720 60p) 720 60p	Suitable for recording fast-moving objects
✓	 (1280×720 30p) 720 30p	Suitable for playback on a computer
	 (480×270 30p) 270 30p	Suitable for faster WEB upload



Progressive playback





The camera supports progressive mode*, which is used in computers, and therefore is suited for playing back images on computers.

* Progressive and Interlaced modes are types of movie recording method. Progressive mode reads out all image pixels at once while Interlaced mode separates a frame into odd/even fields and reads out them alternately.

Delete

Allows you to select unwanted images for deletion.





- 1 Press the function button (▶) to switch to playback mode.
- 2 Press the function button ([Menu]) to display the menu screen.
- 3 Select  (Delete) by using ▲/▼. Then press the MOVIE/ENTER button to decide.







 (This Image)	Deletes the image that is being selected.
 (Multiple Images)	Deletes more than two images at once. Can be selected from only the index screen. ① Select an image, then press the MOVIE/ENTER button. Repeat this step for images you want to delete. If you select the image with  again,  will be released. ② Press the function button ([OK]).

Protect

Protects recorded images against accidental erasure.

The  mark is displayed when playing back registered images.

- 1 Press the function button () to switch to playback mode.
- 2 Press the function button ([Menu]) to display the menu screen.
- 3 Select  (Protect) by using /. Then press the MOVIE/ENTER button to decide.

  (This Image)	Protects the image that is being selected.
  (Multiple Images)	Protects more than two images at once. Can be selected from only the index screen. <ul style="list-style-type: none">① Select an image, then press the MOVIE/ENTER button. Repeat this step for images you want to protect. If you select the image with  again,  will be released.② Press the function button ([OK]).



To cancel the protection



Press the function button ([Menu]) and select [Protect] during playback of the protected image you want to cancel the protection.

The  indicator disappears, and the protection is released.

Share it Later

You can install the Bloggie Software (pre-loaded on the internal memory) to upload images for sharing. You can also choose images and the sharing site to upload in advance. For information on how to upload images, see page 49.

- 1 Press the function button (▶) to switch to playback mode.
- 2 Press the function button ([Menu]) to display the menu screen.
- 3 Select  (Share it Later) by using ▲/▼. Then press the MOVIE/ENTER button to decide.

 (This Image)	Shares the image that is being selected. Select the sharing site and press the function button ([OK]).
 (Multiple Images)	Shares more than two images at once. Can be selected from only the index screen. <ol style="list-style-type: none">① Select an image, then press the MOVIE/ENTER button. Repeat this step for images you want to upload. If you select the image with ✓ again, ✓ will be released.② Press the function button ([Next]) and select sharing site from the share list.③ Press the function button ([OK]).

Notes

- You cannot create the share list with the camera. Use Bloggie Software to create.
- The maximum number of share lists the camera can display is 14.

To cancel sharing

During playback of the image you want to cancel sharing, press the function button ([Menu]) → Select  (Share it Later) → Release the ✓ mark on the sharing site → Press the function button ([OK]).

Flicker Reduction

Curbs the flicker generated by fluorescent by using the electro-shutter.

- 1 Press the function button ([Menu]) → Select  (Settings) → [Flicker Reduction] → desired mode

	On	Uses the Flicker Reduction.
✓	Off	Does not use the Flicker Reduction.

Beep

Sets the sound for when you operate the camera.

- 1 Press the function button ([Menu]) → Select  (Settings) → [Beep] → desired mode.

✓	On	Turns on the beep sound when you press the  (Shutter) button or the MOVIE/ENTER button.
	Off	Turns off the beep sound.

Language Setting

Selects the language to be used in the menu items, warnings and messages.

- 1 Press the function button ([Menu]) → Select  (Settings) → [Language Setting] → desired language.

Demo Mode

Performs a demonstration of the camera.

- 1 Press the function button ([Menu]) → Select  (Settings) → [Demo Mode] → desired mode.

✓	On	Performs a demonstration.
	Off	Does not perform a demonstration.

Note

- The demonstration stops when operating any of the following.
 - Press the  (Shutter) button or the MOVIE/ENTER button.
 - Turn off the power.

Initialize

Initializes the setting to the default setting.

Even if you execute this function, the images are retained.

- 1 Press the function button ([Menu]) → Select  (Settings) → [Initialize]
→ Press the function button ([OK]).

Note

- Perform initialization after charging the camera to prevent the camera from turning off during the process.



When the camera does not work properly

Press and hold the ON/OFF (Power) button for at least 7 seconds, and force-quit the camera (page 15, 16). Then turn the camera on again.

LUN Setting

Sets the display method for the recording media displayed on a computer screen or other monitor when the camera is connected with a computer or AV component using a USB connection.

- 1 Press the function button ([Menu]) → Select  (Settings) → [LUN Setting] → desired mode.

✓	Multi	Select this setting when you connect the camera to a computer.
	Single	Select this setting in cases where the images are not displayed when the camera is connected to a device other than a computer.

HDMI Output

Selects the type of signal to be output to a TV from the HDMI OUT jack. If images are not displayed on the TV clearly, changing the setting may improve the display.

- 1 Press the function button ([Menu]) → Select  (Settings) → [HDMI Output] → desired mode.

✓	60Hz	Outputs with 60Hz.
	50Hz	Outputs with 50Hz.

Format

Formats the internal memory.

- 1 Press the function button ([Menu]) → Select  (Settings) → [Format] → Press the function button ([OK]).

Note

- Note that formatting permanently erases all data including even protected images.

Date & Time Setting

Sets the date and time again.

- 1 Press the function button ([Menu]) → Select  (Settings) → [Date & Time Setting].
- 2 Select the desired item to set.

Date & Time	Sets the date and time (page 28).
Daylight Savings	Pushes forward an hour.

Viewing images on a TV

Connect the camera to a TV which has an HDMI jack with an HDMI cable (sold separately). Refer also to the instruction manuals of the TV.

- 1 Turn off both the camera and the TV.
- 2 Open the jack cover and connect the camera to the TV with the HDMI cable (sold separately).

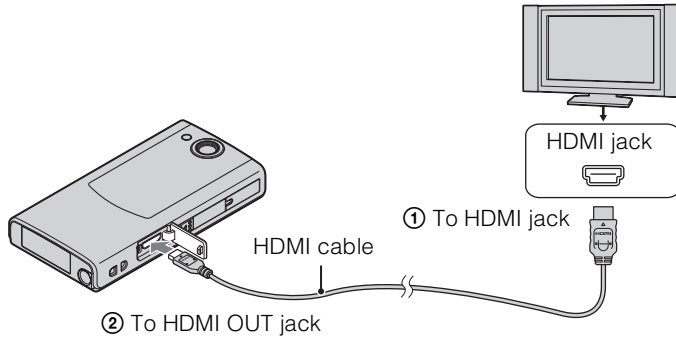

- 3 Turn on the camera.
- 4 Turn on the TV and set the input.
Images shot with the camera appear on the TV.
- 5 Select the images to play back.

Notes

- Connect the mini-HDMI jack of the HDMI cable (sold separately) to the HDMI OUT jack of the camera.
- Do not connect the output jack of the camera to that of other devices. This may result in malfunction.
- Some devices may not work properly. Image and sound may not be output.
- Use an HDMI cable with the HDMI logo.

Using the camera as a Web camera

You can use the camera as a Web camera by connecting it to a computer (USB streaming).

- 1 Connect the camera to a computer.
- 2 Press the function button ([Menu]) → Select [Web Camera].

Notes

- The movie size is fixed to 640 × 480.
- Use the computer's microphone during Web camera mode.

On TV color systems

If you want to view images on a TV screen, you need a TV with an HDMI jack and an HDMI cable (sold separately). The color system of the TV must match that of the camera. Check the following lists for the TV color system of the country or region where the camera is used, and set [HDMI Output] (page 62).

NTSC system

Bahama Islands, Bolivia, Canada, Central America, Chile, Colombia, Ecuador, Jamaica, Japan, Korea, Mexico, Peru, Surinam, Taiwan, the Philippines, the U.S.A., Venezuela, etc.

PAL system

Australia, Austria, Belgium, China, Croatia, Czech Republic, Denmark, Finland, Germany, Holland, Hong Kong, Hungary, Indonesia, Italy, Kuwait, Malaysia, New Zealand, Norway, Poland, Portugal, Rumania, Singapore, Slovak Republic, Spain, Sweden, Switzerland, Thailand, Turkey, United Kingdom, Viet Nam, etc.

PAL-M system

Brazil

PAL-N system

Argentina, Paraguay, Uruguay

SECAM system

Bulgaria, France, Greece, Guiana, Iran, Iraq, Monaco, Russia, Ukraine, etc.

Table of contents

Operation Search

Menu/Settings Search

Index

Troubleshooting

If you experience trouble with the camera, try the following solutions.

① Check the items on pages 68 to 73.

② Turn the power off and then on again.

③ Press and hold the ON/OFF (Power) button for at least 7 seconds, and force-quit the camera. Then turn the camera on again (page 15, 16).

④ Consult your Sony dealer or local authorized Sony service facility.

Be aware that by sending the camera for repair, you give consent that the contents of the internal memory, music files may be checked.

Additional information on this product and answers to frequently asked questions can be found at our Customer Support Website.
<http://www.sony.net/>

Battery pack and power

Cannot turn on the camera.

- The battery pack is discharged. Charge the camera.

The power turns off suddenly.

- Depending on the camera and battery temperature, the power may turn off automatically to protect the camera. In this case, a message is displayed on the LCD screen before the power turns off.
- If you do not operate the camera for a certain period of time while the power is on, the camera turns off automatically to prevent wearing down the battery pack. Turn the camera on again.

Battery life is short.

- Charge the battery until the charge lamp disappears.
- You are using the camera in an extremely hot or cold location, or the charging is insufficient. This is not a malfunction.
- If you have not used the camera for a prolonged period, the efficiency of the battery will be improved by repeatedly charging and discharging it.
- When usable battery life becomes half the usual time, even after charging the battery fully, the battery may need to be replaced. Consult your nearest Sony dealer.

Cannot charge the camera.

- Turn off the camera and make the USB connection.
- Disconnect the USB connection support cable, and then reconnect it.
- Use the USB connection support cable (supplied).
- Charge the battery in an ambient temperature of 10°C to 30°C (50°F to 86°F).
- Turn on the computer and connect the camera.
- Release the computer from sleep or hibernation status.
- Connect the camera directly to a computer using the supplied USB connection support cable.
- Connect the camera to a computer with the operating system that is supported by the camera.
- After trying the remedies above, if the problem still persists, press and hold the ON/OFF (Power) button for at least 7 seconds, and force-quit the camera. Then reconnect it to the computer using the supplied USB connection support cable.

The remaining charge indicator is incorrect.

- This phenomenon occurs when you use the camera in an extremely hot or cold location.
- A discrepancy arose between the remaining charge indicator and the actual remaining battery charge. Fully discharge the battery pack once, then charge it to correct the indication.
- The battery pack is dead (page 75). Consult your nearest Sony dealer.

Shooting still images/movies

Cannot record images.

- Check the free capacity of the internal memory. If it is full, delete unnecessary images (page 53).

The date and time are not displayed on the LCD screen.

- While shooting, the date and time are not displayed. They are displayed only during playback.

Cannot insert dates on images.

- The camera does not have a feature for superimposing dates on images.

Dots appear and remain on the screen.

- This is not a malfunction. These dots are not recorded.

Viewing images

Cannot play back images.

- The folder/file name has been changed on your computer.
- Playback on the camera cannot be guaranteed if files contain images processed on a computer, or images shot by another camera.
- The camera is in USB mode. Disconnect the USB connection (page 23).

The image appears rough right after playback starts.

- This may happen due to image processing. This is not a malfunction.

The image does not appear on the TV.

- Set [HDMI Output] to [60Hz] in NTSC region, [50Hz] in PAL region (page 62).
- Check whether the connection is correct (page 65).

The top and bottom edges of images are trimmed slightly on a connected TV.

- The LCD screen of the camera can display recording images across the entire screen (full pixel display). However, this may cause slight trimming of the top, bottom, right, and left edges of images when played back on a TV that is not compatible with full pixel display.

Black bands appear on the left and right of the screen.

- Black bands appear on the left and right of the screen when viewing movies recorded with the camera held in the vertical position on a TV or a computer. This is not a malfunction.

Deleting

Cannot delete an image.

- Cancel the protection (page 54).

Computers

Your computer does not recognize the camera.

- When the battery level is low, charge the camera.
- Turn on the camera and connect to a computer.
- Use the USB connection support cable (supplied).
- Disconnect the USB connection support cable from both the computer and the camera, and connect it again firmly.
- Disconnect all equipment other than the camera, the keyboard and the mouse from the USB connectors of your computer.
- Connect the camera directly to your computer without passing through a USB hub or other device.
- Set [LUN Setting] to [Multi] (page 61).

Cannot import images.

- Connect the camera and your computer correctly making a USB connection (page 45).
- When you format the internal memory with a computer, you may not be able to import the images to a computer. Format the internal memory with the camera, and shoot (page 63).

After making a USB connection, Bloggie Software does not start automatically.

- Install the Bloggie Software to a computer, and make the USB connection after both the camera and a computer are turned on.

Cannot play back images on your computer.

- Consult the computer or software manufacturer.

The image and sound are interrupted by noise when you view a movie on a computer.

- You are playing back the movie directly from the internal memory. Import the movie to your computer using the Bloggie Software and play it back (page 48).

Others

The camera does not work properly.

- Press and hold the ON/OFF (Power) button for at least 7 seconds, and force-quit the camera. Then turn the camera on again.

The lens gets fogged.

- Moisture condensation has occurred. Turn off the camera and wait about an hour for the moisture to evaporate.

The camera becomes warm when you use it for a long time.

- This is not a malfunction.

The Language/Clock Setting screen appears when you turn on the camera.

- Set the date and time again (page 28).

The date or time is incorrect.

- Set the date and time again (page 64).

Warning indicators and messages

If the following messages appear, follow the instructions.



- The battery level is low. Charge the battery pack immediately. Depending on the conditions of use, the indicator may flash even though there are still 5 to 10 minutes of remaining battery time left.

System error

- Turn the power off and then on again.



- If you record movies for an extended period, the camera temperature rises. In this case, stop recording movies.

Camera overheating

Allow it to cool

- The camera temperature has risen. The power may turn off automatically, or you may be unable to record movies. Leave the camera in a cool location until the temperature goes down.

Internal memory error

- Turn the power off and then on again.

Error formatting internal memory

- Format the media again (page 63).

No images

- No images that can be played back have been recorded on the internal memory.

Folder error

- A folder with the same first three digit number already exists on the internal memory (for example: 123MSDCF and 123ABCDE). Format the camera (page 63).

Cannot create more folders

- The folder with a name beginning with “999” exists on the internal memory. Format the camera (page 63).

File error

- An error occurred while the image was playing back.
Playback on the camera cannot be guaranteed if files contain images processed on a computer, or images shot by another camera.

File protected

- Release the protection (page 54).

Image size over limit

- You are playing back an image with size that cannot be played back on the camera.

Maximum number of images already selected

- Up to 100 files can be selected when using [Delete], [Share it Later] and [Protect].

Operation cannot be executed for movie files

- Playback zoom cannot be performed on movies.

Invalid operation

- This message appears if you perform an invalid operation.

Number of still images and recordable time of movies

The number of still images and recordable time may vary depending on the shooting conditions.

Still images

(Units: Images)

Size	
4:3 (5M)	1309
16:9 (3M)	2890
16:9 (0.4M)	16105

Notes

- When the number of remaining recordable images is greater than 9,999, the “>9999” indicator appears.
- When images recorded using other cameras are played back on this camera, the display may differ from the actual image size.
- When measuring media capacity, 1 GB equals 1 billion bytes, a portion of which is used for data management.

Movies

The table below shows the approximate maximum recording times. These are the total times for all movie files. Continuous shooting is possible for approximately 29 minutes.

(Units: hour : minute : second)

Size	
1920×1080 30p	0:40:00 (0:22:00)
1280×720 60p	1:20:00 (0:36:00)
1280×720 30p	2:00:00 (0:54:00)
480×270 30p	8:00:00 (4:00:00)

Notes

- Your camera uses the VBR (Variable Bit Rate) format to automatically adjust image quality to suit the recording scene. This technology causes fluctuations in the recording time of the internal memory. Movies containing quickly moving and complex images are recorded at a higher bit rate, and this reduces the overall recording time.
- The maximum size of a single movie file is approximately 2 GB. Recording stops before 29 minutes if the file size reaches approximately 2 GB during movie recording.
- The number in () is the minimum recording time.
- When continuous shooting ends, the recording stops automatically.

Built-in battery pack

On charging the battery pack

- We recommend charging the battery pack in an ambient temperature of between 10°C to 30°C (50°F to 86°F). The battery pack may not be effectively charged in temperatures outside this range.
- When usable battery life becomes half the usual time, even after charging the battery fully, the battery should be replaced. Consult your nearest Sony dealer.

Effective use of the battery pack

- Battery performance decreases in low temperature surroundings. So in cold places, the operational time of the battery pack is shorter.
- The battery pack will run out quickly if you use the zoom frequently.
- Do not expose the camera to water. The camera is not water-resistant.
- Do not leave the camera in an extremely hot place, such as in a car or under direct sunlight.

How to store the camera

- Even if you do not use the camera for an extended period, fully charge the camera every 6 to 12 months to maintain the camera's function. Also, store the camera in a cool, dry place.

On battery life

- The battery life is limited. Battery capacity decreases over time and through repeated use. If decreased usage time between charges becomes significant, consult your nearest Sony dealer.
- The battery life varies according to how it is stored and the operating conditions and environment in which each battery pack is used.

Precautions

Do not use/store the camera in the following places

- In an extremely hot, cold or humid place
In places such as in a car parked in the sun, the camera body may become deformed and this may cause a malfunction.
- Under direct sunlight or near a heater
The camera body may become discolored or deformed, and this may cause a malfunction.
- In a location subject to rocking vibration
- Near strong magnetic fields
- In sandy or dusty places
Be careful not to let sand or dust get into the camera. This may cause the camera to malfunction, and in some cases may be irreparable.

On carrying

Do not sit down in a chair or other place with the camera in the back pocket of your trousers or skirt, as this may cause malfunction or damage the camera.

On cleaning

Cleaning the lens

Wipe the lens with a soft cloth to remove fingerprints, dust, etc.

Cleaning the camera surface

Clean the camera surface with a soft cloth slightly moistened with water, then wipe the surface with a dry cloth. Do not use any of the following as they may damage the finish or the casing.

- Chemical products such as thinner, benzene, alcohol, disposable cloths, insect repellent, sunscreen or insecticide, etc.
- Do not touch the camera with any of the above on your hand.
- Do not leave the camera in contact with rubber or vinyl for a long time.

On operating temperatures

Your camera is designed for use under the temperatures between 0°C and 40°C (32°F and 104°F). Shooting in extremely cold or hot places that exceed this range is not recommended.

On moisture condensation

If the camera is brought directly from a cold to a warm location, moisture may condense inside or outside the camera. This moisture condensation may cause a malfunction of the camera.

If moisture condensation occurs

Turn off the camera and wait about an hour for the moisture to evaporate.

Note on disposal/transfer

- When using the software pre-loaded on the internal memory, personal information such as IDs and mail addresses may be saved on the internal memory of the camera. Before changing ownership of the camera, or before disposal, delete any personal information.
- Even if you delete data on the internal memory or format the camera, you may not delete data from the internal memory completely.
- To prevent the camera from restoring the internal memory data, record any unnecessary data on the internal memory of the camera.

Specifications

Camera

[System]

Image device: 4.5 mm (1/4 type) CMOS sensor

Total pixel number of camera:

Approx. 5 110 000 pixels

Effective pixel number of camera:

Approx. 3 110 000 pixels (still image, 16:9),

Approx. 5 030 000 pixels (still image, 4:3),

Approx. 3 110 000 pixels ([1920×1080 30p] movie)

Lens: F2.8

f = 4.1 mm (3/16 inches)

When converted to a 35 mm still camera

For movies: 47 mm (1 7/8 inches) (16:9)

For still images: 41 mm (1 5/8 inches) (4:3)

Exposure control: Automatic exposure

File format:

Still images: JPEG (DCF Ver. 2.0, Exif Ver. 2.3, MPF Baseline) compliant

Movies: MPEG-4 AVC/H.264 (MP4)

Audio: MPEG AAC

Recording media: Internal Memory (Approx. 4 GB)

- When measuring media capacity, 1 GB equals 1 billion bytes, a portion of which is used for system management and/or application files. Available user capacity is as below. Approx. 3.7 GB

[Input and Output connectors]

HDMI jack: HDMI mini connector

USB jack: type A (built-in)

USB communication: Hi-Speed USB (USB 2.0 compliant)

[LCD screen]

MHS-FS1/FS1K

LCD screen: 6.7 cm 2.7 type (16:9) TFT drive

Total number of dots: 230 400 (960 × 240) dots

MHS-FS2/FS2K

Main Display: 6.7 cm 2.7 type (16:9) TFT drive

Total number of dots: 230 400 (960 × 240) dots

Front Display: 5.0 cm 2.0 type (4:3) TFT drive

Total number of dots: 153 600 (640 × 240) dots

[Power, general]

Power:

Built-in rechargeable battery pack

USB charging (supplied from the computer by connecting with the supplied USB connection support cable)

Charging time: Approx. 200 mins. (full charge)

(when charging from the USB connector of the computer)

Power consumption (during shooting): 1.7 W

(when the movie image size is [1280×720 30p])

Operating temperature: 0°C to 40°C (32°F to 104°F)

Storage temperature: -20°C to +60°C (-4°F to +140°F)

Dimensions (Approx.):

MHS-FS1/FS1K

55.0 mm × 108.0 mm × 15.8 mm (2 1/4 inches × 4 3/8 inches × 5/8 inches)

MHS-FS2/FS2K

55.0 mm × 108.0 mm × 18.4 mm (2 1/4 inches × 4 3/8 inches × 3/4 inches)

(W/H/D, excluding protrusions)

Mass:

MHS-FS1/FS1K

Approx. 115 g (4.1 oz)

MHS-FS2/FS2K

Approx. 139 g (4.9 oz)

Microphone: Monaural

Speaker: Monaural

Design and specifications are subject to change without notice.

Table of contents

Operation Search

Menu/Settings Search

Index

Trademarks

- “Bloggie” is a trademark of Sony Corporation.
- 360 Video is a trademark of Sony Corporation.
- HDMI, the HDMI logo and High-Definition Multimedia Interface are trademarks or registered trademarks of HDMI Licensing LLC in the United States and other countries.



- Microsoft, Windows, Windows Vista and DirectX are either registered trademarks or trademarks of Microsoft Corporation in the United States and/or other countries.
- Macintosh, Mac OS, the Mac OS logo, iMac, iBook, PowerBook, Power Mac and eMac are trademarks or registered trademarks of Apple Inc.
- Intel and Pentium are trademarks or registered trademarks of Intel Corporation.

In addition, system and product names used in this manual are, in general, trademarks or registered trademarks of their respective developers or manufacturers. However, the TM or © marks are not used in all cases in this manual.

Notes on the License

THIS PRODUCT IS LICENSED UNDER THE AVC PATENT PORTFOLIO LICENSE FOR THE PERSONAL AND NON-COMMERCIAL USE OF A CONSUMER TO (i) ENCODE VIDEO IN COMPLIANCE WITH THE AVC STANDARD (“AVC VIDEO”) AND /OR (ii) DECODE AVC VIDEO THAT WAS ENCODED BY A CONSUMER ENGAGED IN A PERSONAL AND NON-COMMERCIAL ACTIVITY AND/OR WAS OBTAINED FROM A VIDEO PROVIDER LICENSED TO PROVIDE AVC VIDEO. NO LICENSE IS GRANTED OR SHALL BE IMPLIED FOR ANY OTHER USE. ADDITIONAL INFORMATION MAY BE OBTAINED FROM MPEG LA, L.L.C. SEE <[HTTP://WWW.MPEGLA.COM](http://www.mpegla.com)>

Index

Numerics

360 Video images37

B

Battery pack75

Beep57

Bloggie Software25, 47

C

Charging22

Clock Settings28

Computer

 Importing images48

 Recommended environment45

 Uploading images49

Connecting

 Computer48

D

Date & Time Setting64

Daylight Savings64

Delete53

Demo Mode59

F

Flicker Reduction56

Format63

H

HDMI OUT jack65

HDMI Output62

I

Identifying parts15, 16

Initialize60

Install25

L

Language Setting58

LUN Setting61

M

Macintosh computer45

Movie Size52

N

Number of still images74

O

OS45

P

Photo Size50

Pixel51

Playback zoom43

Protect54

R

Recordable time of movies74

S

Self-Timer35

Settings13

Share it Later55

Shooting

 Movies31

 Still images29

Software25, 47

T

Troubleshooting68

U

USB22, 25

V

View

 Movies40

 Still images40

Volume control44

W

Warning messages.....	72
Web camera	66
Windows computer.....	45

Z

Zoom.....	33
-----------	----

Table of contents

Operation Search

Menu/Settings Search

Index