

# SONY®

4-418-730-11(1)

## LCD TV

### Operating Instructions

---

Introducing Your New  
BRAVIA®

---

Getting Started

---

Operating the TV

---

Using Features

---

Using the Menus

---

Other Information

### Sony Customer Support

U.S.A.: <http://www.sony.com/tvsupport>

Canada: <http://www.sony.ca/support>

United States

Canada

1.800.222.SONY

1.877.899.SONY

Please Do Not Return  
the Product to the Store

# BRAVIA

## Owner's Record

The model and serial numbers are located at the side and rear of the TV. Record these numbers in the spaces provided below. Refer to them whenever you call upon your Sony dealer regarding this TV.

Model Name

\_\_\_\_\_

Serial No.

\_\_\_\_\_



## CAUTION

To prevent electric shock and blade exposure, do not use this polarized AC plug with an extension cord, receptacle or other outlet unless the blades can be fully inserted.

- Operate the TV only on 110-240 V AC (USA/Canada 120 V AC).
- Avoid operating the TV at temperatures below 41°F (5°C).

## Licensing Information

Macintosh is a trademark of Apple Inc., registered in the U.S. and other countries.

HDMI, the HDMI logo, and High-Definition Multimedia Interface are trademarks or registered trademarks of HDMI Licensing, LLC in the United States and other countries.

Ferguson Patent Properties, LLC:

U.S. Patent No. 5,717,422

U.S. Patent No. 6,816,141

Manufactured under license from Dolby Laboratories. Dolby and the double-D symbol are trademarks of Dolby Laboratories.

Blu-ray Disc is a trademark.

"BRAVIA" and BRAVIA, BRAVIA Sync, and  are trademarks or registered marks of Sony Corporation.

"PlayStation" is a registered trademark and "PS3" is a trademark of Sony Computer Entertainment Inc.

Opera® Browser from Opera Software ASA. Copyright 1995-2012 Opera Software ASA. All rights reserved.

DLNA®, the DLNA Logo and DLNA CERTIFIED® are trademarks, service marks, or certification marks of the Digital Living Network Alliance.

## Cleaning

When cleaning, be sure to unplug the power cord to avoid any chance of electric shock.

- Wipe the LCD screen gently with a soft cloth.
- Stubborn stains may be removed with a cloth slightly moistened with a solution of mild soap and warm water.
- If using a chemically pretreated cloth, please follow the instruction provided on the package.
- Never use strong solvents such as a thinner, alcohol or benzene for cleaning.
- See the supplied Safety Booklet for additional information.

Your BRAVIA TV is ENERGY STAR® qualified in the "Home" mode. It meets strict energy efficiency guidelines set by the U.S. Environmental Protection Agency and Department of Energy.



ENERGY STAR is a joint program of these government agencies, designed to promote energy efficient products and practices. Changes to certain features, settings, and functionalities of this TV (i.e. TV Guide, Picture/Sound, Light Sensor, Power Savings) can increase or change the power consumption. Depending upon such changed settings, the power consumption may exceed the limits required for the ENERGY STAR qualification in the "Home" mode.

Wi-Fi Protected Set-up™ (WPS) is a mark of the Wi-Fi Alliance.

Wi-Fi Protected Access™ (WPA) is a mark of the Wi-Fi Alliance.

The 55 class has a 54.6 inch viewable image size (measured diagonally).

# Contents

## **Introducing Your New BRAVIA®**

Welcome to the World of BRAVIA®	4
Experiencing Stunning HD with Your BRAVIA	4
The Four Steps to a Stunning HD Experience	5
TV Feature Highlights	5

## **Getting Started**

Setting Up Your TV	7
Attaching the Table-Top Stand	8
Adjusting the viewing angle of the TV	10
Locating Inputs and Outputs	11
Connecting the TV	13
Connecting Other Equipment	17
When Installing the TV Against a Wall or Enclosed Area	18
Securing the TV	19
Bundling the cables	21
Running Initial Setup	22

## **Operating the TV**

Using the Remote Control	24
Remote Control Button Description	25
TV Controls and Indicators	28

## **Using Features**

BRAVIA® Sync™ with Control for HDMI	30
Using PIP Feature	31
Using PAP feature	32
Favorites	33
Wide Mode	33
Wide Mode with PC	34

Inputs	35
Playing back Photo/Music/Video via USB	35
Home Network	38
Photo Frame	39
Using Home Network Features	40
Setting up the Internet Connection	41
If You Cannot Connect to the Internet	44
Adjusting the Server Display Settings	44
Browsing Websites	45
Enjoying Sony Entertainment Network	45
Enjoying Yahoo! Widgets	46

## **Using the Menus**

Navigating through TV Menus	48
Using the Picture Settings	50
Using the Sound Settings	52
Using the Screen Settings	54
Using the Channel Settings	56
Using the Parental Lock Settings	57
Using the Setup Settings	60
Using the Eco Settings	66

## **Other Information**

PC Input Signal Reference Chart for PC and HDMI IN	67
Using a Wall-Mount Bracket	68
Installing the Wall-Mount Bracket	69
Troubleshooting	74
Important Notices	81
Specifications	82
Index	84



Customer Support  
United States  
<http://www.sony.com/tvsupport>  
Canada  
<http://www.sony.ca/support>

On-line Registration  
United States  
<http://productregistration.sony.com>  
Canada  
<http://www.sony.ca/registration>

# Welcome to the World of BRAVIA®

---

Thank you for choosing this Sony BRAVIA® high-definition television. Use the documentation listed below to get the most out of your TV.



## **Safety Booklet**

Contains precautionary measures to keep you and your TV safe. Read this information prior to setting up your TV.



## **Quick Setup Guide**

Provides TV setup information with sample connection diagrams.



## **Operating Instructions**

Provides the most detailed information to operate your TV.



## **Operating Instructions for the USB Wireless LAN Adapter**

Provides the most detailed information about safety, regulatory and specifications of the USB Wireless LAN adapter.

## Experiencing Stunning HD with Your BRAVIA

---

The quality of the image you see on your **BRAVIA** TV is only as good as the quality of the signal it receives. To experience the stunning detail of your new **BRAVIA** TV, you need access to HD programming. Your **BRAVIA** TV can receive and display HD programming from:

- Over-the-air broadcasting via HD-quality antenna
- HD cable subscription
- HD satellite subscription
- Blu-ray Disc™ player or other HD compatible external equipment

Contact your cable, satellite or HD service provider for information on upgrading to HD programming.

# The Four Steps to a Stunning HD Experience

## Set, Source, Sound, and Setup

Along with your **BRAVIA TV set**, a complete HD system requires a **source** of HD programming, an HD **sound** system, and a proper connection **setup**. Refer to the Quick Setup Guide, enclosed separately, for connecting optional equipment.



You can enjoy crisp, clear images, smooth movement, and high-impact visuals from 1080 HD signals as shown here.

When you compare a high-definition signal to a standard analog signal, you will notice a big difference in picture quality. If black bars appear as shown here, press **WIDE** on the remote control to fill the screen.

## TV Feature Highlights

Your **BRAVIA** comes with many convenient features, such as:

- **BRAVIA® Sync™**: Allows your **BRAVIA TV** to communicate with other Sony equipment supporting the **Control for HDMI** function (page 30).
- **Digital Media Accessibility**: Use the **Photo**, **Music**, and **Video** icons to access photo, music, and video files from DLNA Certified™ networked equipment or Sony USB equipment (page 35).
- **PIP (Picture in Picture)**: You can work on your PC and watch your favorite TV program simultaneously (page 31).
- **PAP (Picture and Picture)**  
You can display two pictures (left and right) on the screen simultaneously (page 32).
- **Favorites**: Your favorite channels and inputs are at your finger tips for easy access (page 33).
- **Auto Wide Mode**: Set your TV to automatically adjust the screen based on the signal resolution (page 33).

- **Input Selection:** Allows you to easily switch between the connected equipment (page 35).
- **Scene Select:** Allows you to easily adjust your TV to the most suitable picture and sound settings based on the scenes for the best quality result for the contents genre you are watching (page 26).
- **Yahoo! Widgets:** Yahoo! TV Widgets bring the best of the Internet to your TV (page 46). Yahoo! Widgets allow you to access local weather, news and much more.
- **DLNA:** You can enjoy various content (e.g. photo/music/video files) stored on DLNA Certified™ media servers. The home network feature allows you to enjoy network content in other rooms. (page 38).
- **Internet Video:** Internet Video brings videos, movies and much more from the Internet to your TV (page 45).
- **Browser:** Allows you easily browse websites.
- **Photo Frame:** You can enjoy the large photo frame display with music.

# Setting Up Your TV

Some TV models are packaged with a detached Table-Top Stand so you can mount your TV to a wall right away. If you are not mounting the TV to a wall, you will need to attach the Table-Top Stand. You will need a Phillips screwdriver and the supplied screws to complete the task. Look for the attachment instructions provided with the TV. Be sure to consider the following while setting up your TV:

- Disconnect all cables when carrying the TV.
- Carry the TV with the adequate number of people; larger size TVs require two or more people.
- Correct hand placement while carrying the TV is very important for safety and to avoid damage.

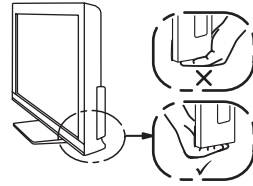
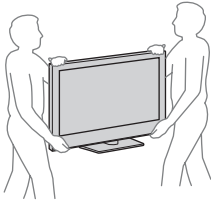

- Ensure your TV has adequate ventilation, see page 18.
- For best picture quality, do not expose the screen to direct illumination or sunlight.
- Avoid installing the TV in a room with reflective wall and floor materials.
- Avoid moving the TV from a cold area to a warm area. Sudden room temperature changes may cause moisture condensation. This may cause the TV to show poor picture and/or poor color. Should this occur, allow moisture to evaporate completely before powering the TV on.

# Attaching the Table-Top Stand

Refer to the supplied Table-Top Stand leaflet for proper attachment.



- Do not put stress on the LCD panel or the frame around the screen.
- Be careful to not pinch your hands or the AC power cord when you install the TV set to the Table-Top Stand.

**1** Place the TV set on the Table-Top Stand.

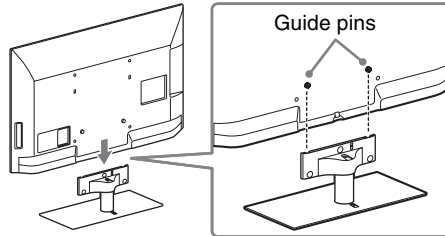

- Align the TV from the top, slide it in until the guide pins cannot be seen.

**2** Fix the TV to the Table-Top Stand using the supplied screws. The arrow marks  indicate the location of the screw holes used for securing the Table-Top Stand.

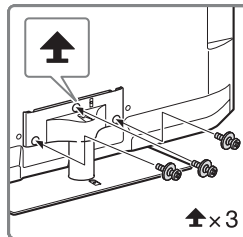

- If using an electric screwdriver, set the torque at approximately 1.5 N·m {15 kgf·cm}.



## Detaching the Table-Top Stand from the TV

To detach the Table-Top Stand from the TV, remove the screws  fixed in step 2.



- Do not remove the Table-Top Stand for any reason other than to install corresponding accessories on the TV.
- When removing the Table-Top Stand from the TV, lay the display face down on a stable work surface that is larger than the TV.
- To prevent damaging the surface of the LCD display, make sure to place a soft cloth on the work surface.
- When installing the TV on a wall, remove the screws from the rear of the TV. Be sure to store the removed screws in a safe place, keeping them away from children.
- When attaching the Table-Top Stand again, be sure to fasten the screws (previously removed) to the original holes on the rear of the TV.

# Adjusting the viewing angle of the TV

This TV can be adjusted within the angles as illustrated.

## ■ Angle Adjustment (Swivel)



- When adjusting the angle, hold the stand with one hand to avoid having the stand slip or TV tip over.

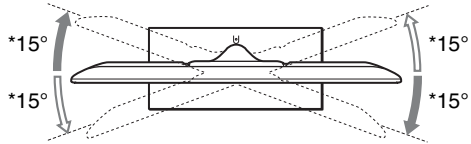

\* The angle is approximate value.

# Locating Inputs and Outputs

Rear Panel

Side Panel

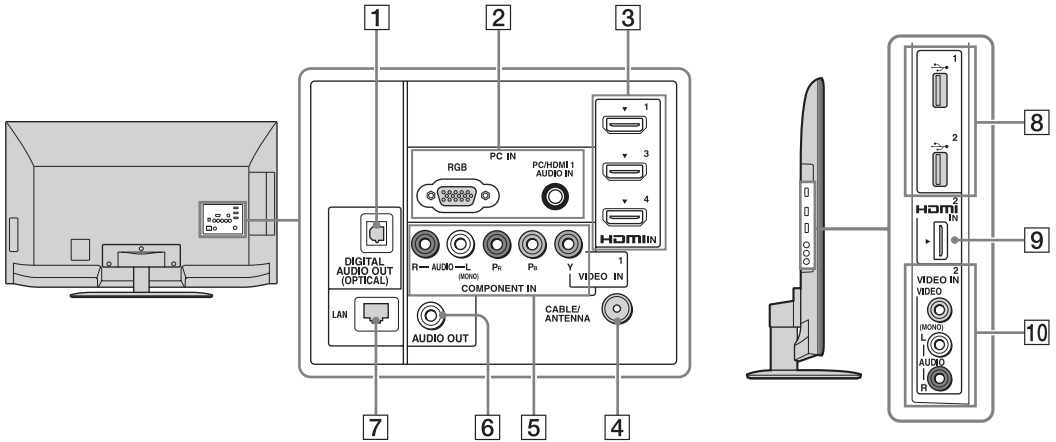

Item	Description
<b>1</b>	<b>DIGITAL AUDIO OUT (OPTICAL)</b> Connects to the optical audio input of digital audio equipment that is PCM/Dolby* Digital compatible.
<b>2</b>	<b>PC IN (RGB)</b> Connects to a personal computer's video and audio output connector. Can also be connected to other analog RGB equipment. See "PC Input Signal Reference Chart" on page 67 for the signals that can be displayed. For some Apple Macintosh computers, it may be necessary to use an adapter (not supplied). If an adapter is used, connect the adapter to the computer before connecting the HD15-HD15 cable. You may need to adjust the TV settings or your PC's resolution and timing. See page 16 for information on how to setup your PC to this TV.
<b>3, 9</b>	<b>HDMI IN 1/2/3/4</b> HDMI (High-Definition Multimedia Interface) provides an uncompressed, all-digital audio/video interface between this TV and any HDMI-equipped audio/video equipment, such as a set-top box, DVD player, and A/V receiver. HDMI supports enhanced, or high-definition video, plus digital audio. Be sure to use only an HDMI cable that bears the HDMI logo. Use the HDMI IN 1 port when connecting DVI equipment. Use a DVI-to-HDMI cable or adapter (not supplied). Equipment using a DVI connection also requires an additional audio connection using an audio cable connected to PC/HDMI 1 AUDIO IN of PC IN.

\* Manufactured under license from Dolby Laboratories. Dolby and the double-D symbol are trademarks of Dolby Laboratories.

Item	Description
4 <b>CABLE/ ANTENNA</b>	RF input that connects to your Cable or VHF/UHF antenna.
5 <b>VIDEO IN 1/ COMPONENT IN/R-AUDIO-L (MONO)</b>	<p>This input port can be used as a composite video input (VIDEO 1) or as a component video input (COMPONENT). For composite use, connect the yellow jack to Y for video and use audio L (mono) and R for audio signal. For component connection, use Y, P<sub>B</sub>, P<sub>R</sub> for video signals and also connect the audio L (mono) and R for audio signal.</p> <p>This TV can auto detect and switch between the VIDEO 1 and COMPONENT when VIDEO 1 or COMPONENT is connected.</p> <p>To set to auto detection, press <b>HOME</b>, select <b>Settings</b>, and then select the <b>Setup</b> settings. Select the <b>Video1/Component Selection</b> option in <b>AV Setup</b> then set to <b>Auto</b>.</p>
6 <b>AUDIO OUT</b>	Connects to the audio input jack of your analog audio equipment. You can use this output to listen to your TV's audio through your stereo system.
7 <b>LAN</b>	You can enjoy contents stored in DLNA Certified™ devices via a network (page 35), and also IPTV, Yahoo! Widgets and Internet Browser are available.
8 <b>USB</b>	Connects to USB equipment to access photo, music, and video files. The USB Wireless LAN Adapter (UWA-BR100) is available as an optional accessory.
10 <b>VIDEO IN 2 VIDEO/L (MONO)- AUDIO-R</b>	<p>Connects to the composite video output jack of video equipment.</p> <p>If you have mono equipment, connect its audio output port to the TV's L (MONO) audio input port.</p>



- An HDMI or Component video (YPbPr) connection is required to view 480i, 480p, 720p, 1080i and 1080p video formats. 1080/24p is available only with HDMI connection.

# Connecting the TV

## Cable System or VHF/UHF Antenna System

You can enjoy high-definition and standard-definition digital programming (if available in your area) along with standard-definition analog programming.

This TV is capable of receiving unscrambled digital programming for both cable (QAM and 8VSB) and external VHF/UHF antenna (ATSC).

### ■ Cable or VHF/UHF (or VHF only)



- It is strongly recommended that you connect the CABLE/ANTENNA input using a 75-ohm coaxial cable to receive optimum picture quality. A 300-ohm twin lead cable can easily be affected by radio frequency interference, resulting in signal degradation.

## Cable System and VHF/UHF Antenna System

Use an optional A-B RF switch (not supplied) to switch between the cable and over-the-air antenna programming, as indicated below.

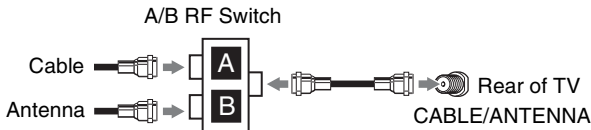

- Be sure to set the **Signal Type** setting to **Cable** or **Antenna** found under the **Channel** settings for your input signal (page 56).

## HD Cable Box/HD Satellite Box

You can enjoy high-definition programming by subscribing to a high-definition cable service or a high-definition satellite service. For the best possible picture, make sure you connect this equipment to your TV via the HDMI or component video (with audio) input located on the back of your TV.

### ■ Shown with HDMI Connection

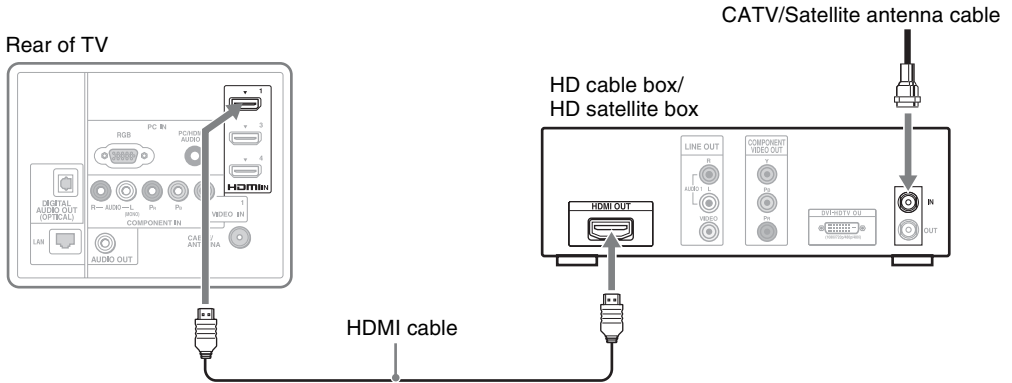

### ■ Shown with DVI Connection

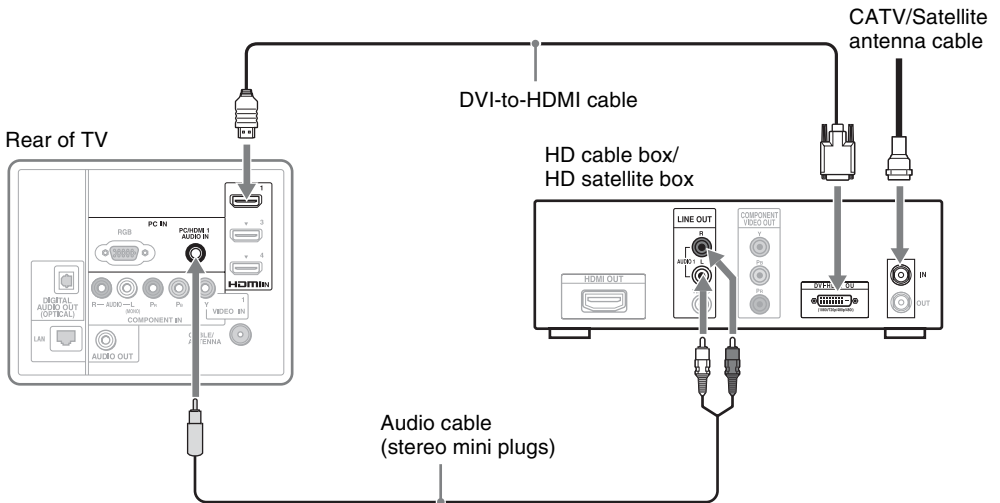

## ■ Shown with Component Connection

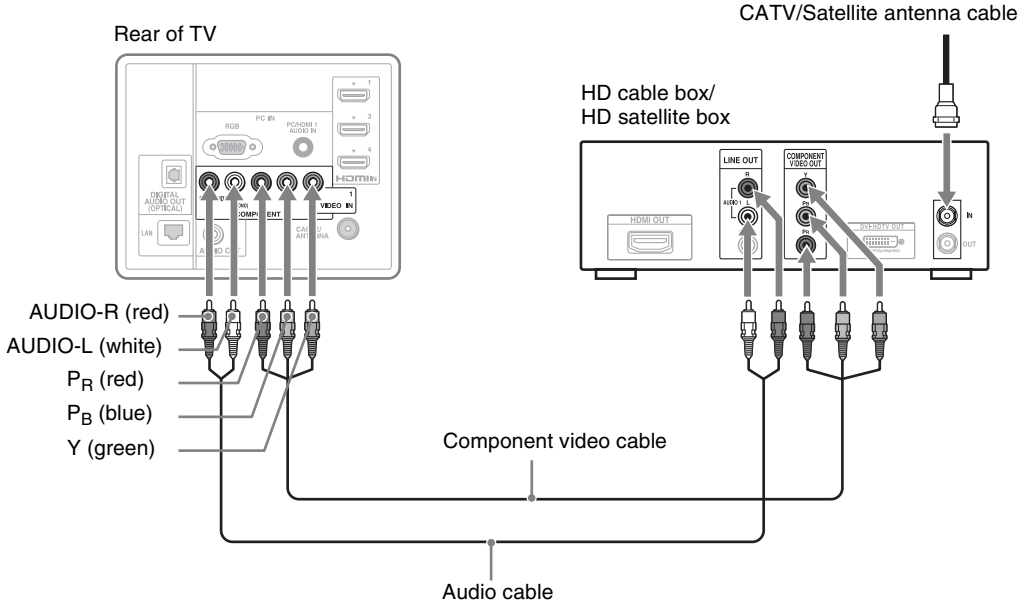

- If your equipment has a DVI output and not an HDMI output, connect the DVI output to the HDMI IN 1 (with DVI-to-HDMI cable or adapter) and connect the audio output to the AUDIO IN of PC IN. For details, see page 11.

## PC

Use the TV as a monitor for your PC by connecting an HD15-HD15 cable connection as shown below. This TV can also be connected to a PC with a DVI or HDMI output. (Refer to the separate Quick Setup Guide.)

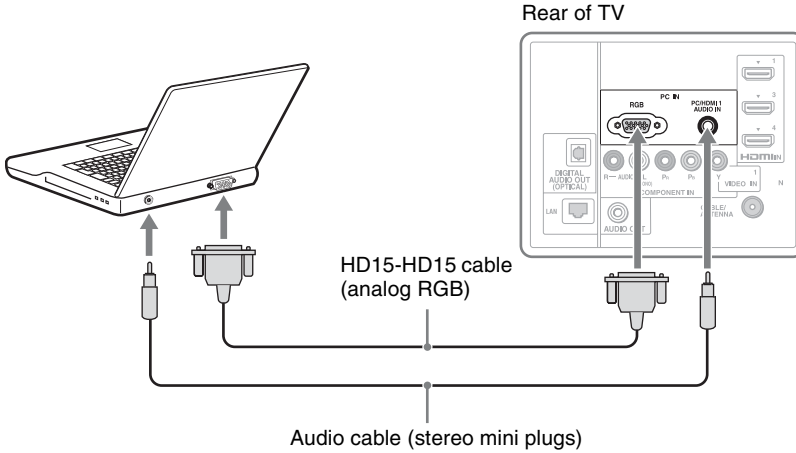

- Connect the PC IN jack to the PC using an HD15-HD15 cable with ferrite core (analog RGB) and audio cable (page 11).



# Connecting Other Equipment

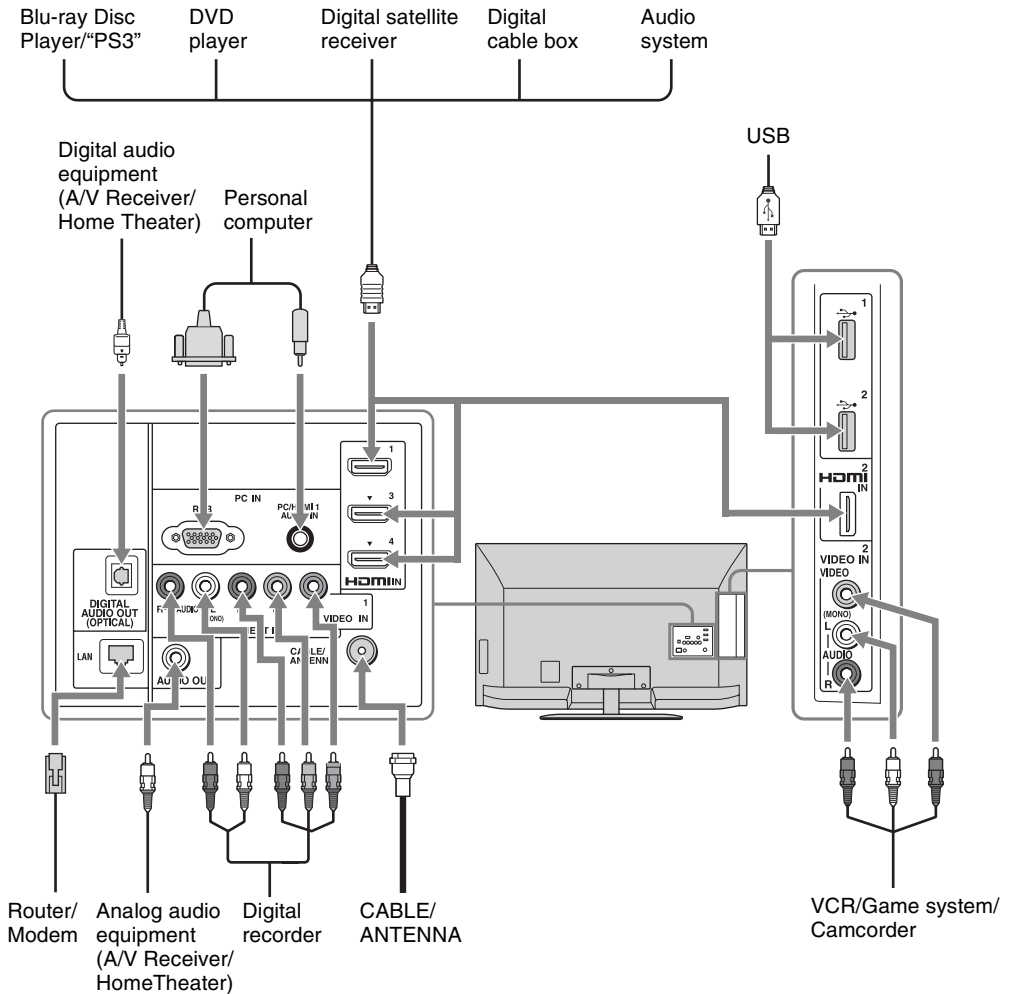

- Refer to the Quick Setup Guide (supplied) when connecting other equipment to your TV.

# When Installing the TV Against a Wall or Enclosed Area

Make sure that your TV has adequate ventilation. Allow enough space around the TV as shown below. Avoid operating the TV at temperatures below 41 °F (5 °C).

## Installed with stand

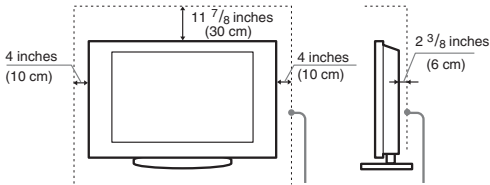

Leave at least this much space around the set.

## Installed on the wall

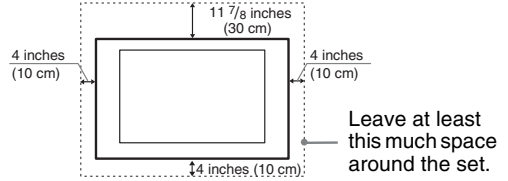

Never install the TV set as follows:

Air circulation is blocked.

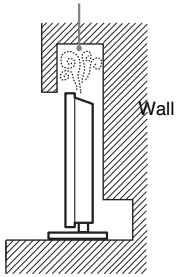

Air circulation is blocked.

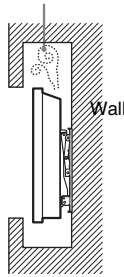

- Inadequate ventilation can lead to overheating of the TV and may cause TV damage or cause a fire.

# Securing the TV



Sony strongly recommends taking measures to prevent the TV from toppling over. Unsecured TVs may topple and result in property damage, serious bodily injury or even death.

## Preventing the TV from Toppling

- Secure the TV to a wall and/or stand.
- Do not allow children to play or climb on furniture and TV sets.
- Avoid placing or hanging items on the TV.
- Never install the TV on:
  - slippery, unstable and/or uneven surfaces.
  - furniture that can easily be used as steps, such as a chest of drawers.
- Install the TV where it cannot be pulled, pushed, or knocked over.
- Route all AC power cords and connecting cables so that they are not accessible to curious children.

## Recommended Measures to Secure the TV

Consider the following measures when securing your TV to a TV stand (not supplied).

### 1 Secure the stand for the TV.

Make sure the TV stand can adequately support the weight of the TV. Use two angle braces (not supplied) to secure the stand.

For each angle brace use the appropriate hardware to:

- attach one side of the angle brace to the wall stud.
- attach the other side to the TV stand.

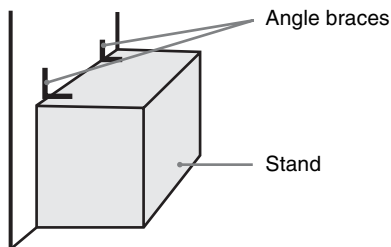

## 2 Secure the TV to the stand.

Use the optional hardware listed below (not supplied):

- M4 machine screw (screwed into the TV's Table-Top Stand).
- A screw or similar (attach it to the TV stand).
- Rope or chain (strong enough to support the weight of the TV). Make sure that there is no excess slack in the rope or chain.

An alternative way to secure the TV is with an optional Sony Support Belt Kit.

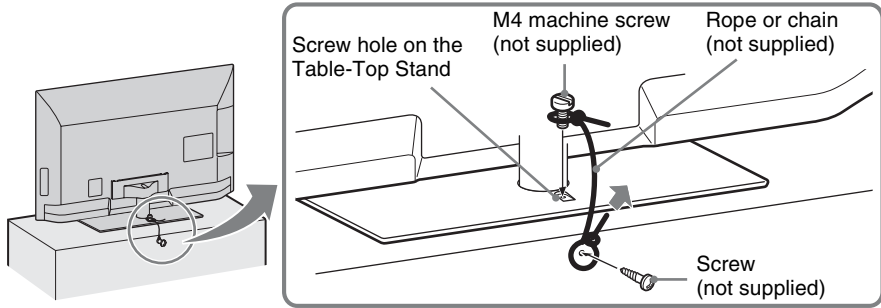

The length of the M4 machine screw differs depending on the rope or chain diameter. Please refer to right illustration.

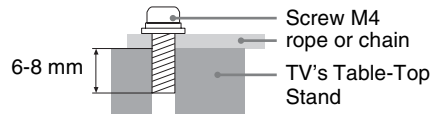

## 3 Anchor the TV to the wall.

Anchor the TV to the wall by using bolts, wall anchor and chain (or rope).

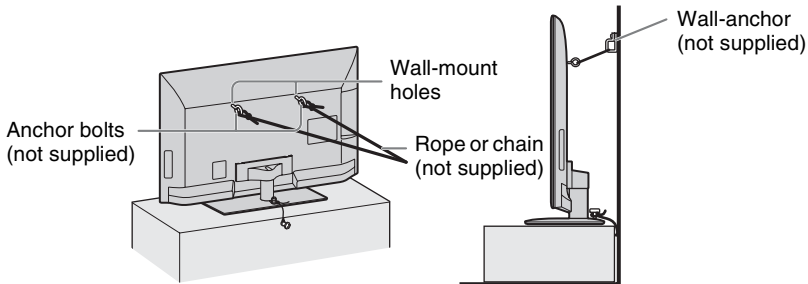

- Contact Sony Customer Support to obtain the optional Support Belt Kit by providing your TV model name.  
For United States call: 1-800-488-7669 or visit: [www.sony.com/accessories](http://www.sony.com/accessories)  
For Canada call: 1-877-899-7669
- Securing the TV to the stand without securing the TV and the stand to the wall provides minimum protection against the TV toppling over. For further protection, be sure to follow the three measures recommended.

# Bundling the cables

Before bundling the cables, remove the cable holder from the AC cover. Reuse the cable holder to bundle the other cables.



- Do not bundle the AC power cord together with other cables.

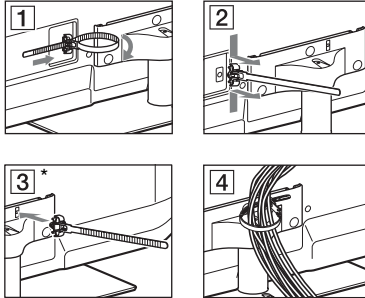

- \* When installing on the wall, attach the cable holder under the terminals.

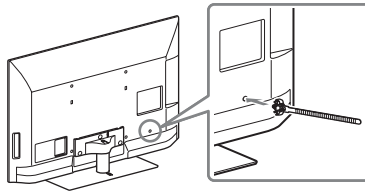

# Running Initial Setup

During initial setup, you will perform the following:

- Set the language for the On Screen Display (OSD) text
- Choose your viewing country
- Select the type of use
- Scan for digital and analog channels
- Set the current time
- Set the network setup
- Download the software

Complete your cable connections before beginning the **Initial Setup**. Refer to the Quick Setup Guide (supplied) for sample connection diagrams.



- 1 Turn on the TV.  
The **Initial Setup** screen will appear.

- 2 Use the remote control buttons described below to navigate through the **Initial Setup**.

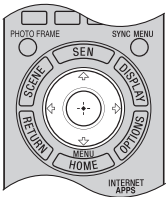

**↑/↓/←/→ buttons:**

Allow you to navigate and highlight options where applicable.

**+ button:**

Allows you to select the highlighted option and advance to the next screen.

- 3 **Auto Program** will scan for available channels from the signal source directly connected to the TV's CABLE/ANTENNA input. Follow the help text provided on the screen to run the **Auto Program**.



- If you cancel the **Auto Program**, any channels you have selected are not registered. To rescan for available channels, run **Auto Program**.
- Connect either your cable or antenna to the TV (you can connect both using an A-B RF switch (not supplied)); for more details see page 13.
- When promoted to select **Retail** or **Home**, be sure to select **Home** for ENERGY STAR compliant mode.

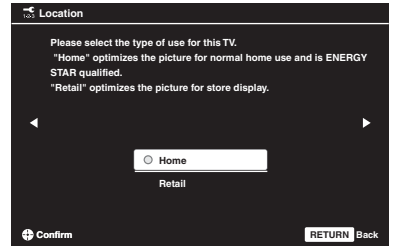

# Using the Remote Control

## To Insert Batteries into the Remote Control

Insert two size AAA batteries (supplied) by matching  $\oplus$  and  $\ominus$  on the batteries to the diagram inside the battery compartment of the remote control.

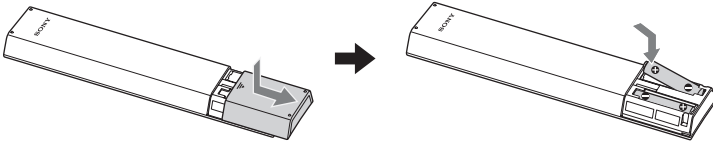

## Guidelines to follow

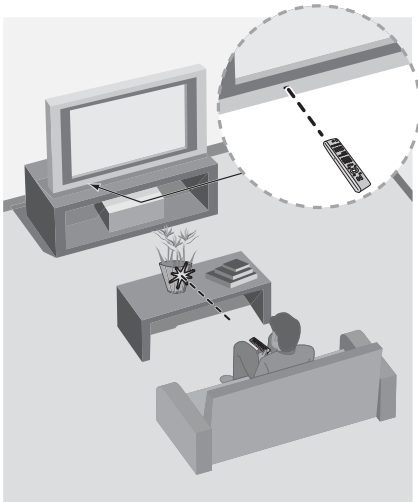

- Point your remote control directly at the IR sensor located on your TV.
- Make sure that no objects are blocking the path between the remote control and the IR sensor on your TV.
- Fluorescent lamps can interfere with your remote control; try turning off the fluorescent lamps.
- If you are having problems with the remote control, reinsert or replace your batteries and make sure that they are correctly inserted.
- Ensure that there are no objects in front of the TV.

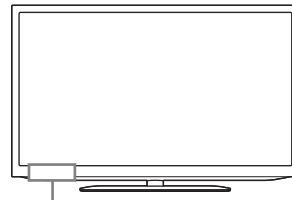

IR Sensor



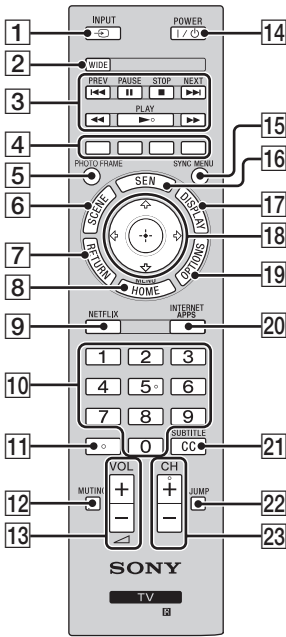

# Remote Control Button Description



Button	Description
1 <b>INPUT</b>	Press to display the list of External Inputs and TV mode. Press repeatedly to toggle through the inputs. See page 35.
2 <b>WIDE</b>	Press repeatedly to cycle through the available <b>Wide Mode</b> settings. See page 33.
3 <b>Equipment Control</b>	These buttons are used to control the equipment connected to the TV by using the <b>Control for HDMI</b> function (not available on all <b>Control for HDMI</b> equipment). Some other buttons on the remote control may also operate <b>BRAVIA®</b> Sync™ equipment.  <b>◀◀ (PREV):</b> Press to replay the current program from the previous chapter mark. <b>⏸ (PAUSE):</b> Press to pause playback. <b>■ (STOP):</b> Press to stop playback. <b>▶▶ (NEXT):</b> Press to advance forward to the next chapter mark. <b>◀◀ (fast reverse):</b> Press to play a program in fast rewind mode. <b>▶ (PLAY):</b> Press to play a program at a normal speed. <b>▶▶ (fast forward):</b> Press to play a program in fast forward mode.
4 <b>Colored buttons</b>	When the colored buttons are available, an operation guide appears on the screen.



- The 5, ▶, and CH + buttons have a tactile dot. Use them as a reference when operating the TV.

Button	Description
5 <b>PHOTO FRAME</b>	Press to display the Photo Frame. See page 39.
6 <b>SCENE</b>	Optimizes picture and sound quality by selecting the following items. <b>Auto:</b> Automatically optimizes picture and sound quality according to the input source. <b>General:</b> No optimized picture and sound quality for any scene. <b>Photo:</b> Reproduces the texture and color of a printed photo. <b>Music:</b> Lets you experience dynamic and clear sound just like at a concert. <b>Cinema:</b> Delivers picture and sound just like in a theater. <b>Game:</b> Broadens your game-playing experience with superb picture and sound quality. <b>Graphics:</b> Eases prolonged monitor viewing with clearer detailed pictures. <b>Sports:</b> Presents realistic pictures and sound just like in a stadium.
7 <b>RETURN</b>	Press to go back to the previous screen or exit from the screen when displaying menu items and settings.
8 <b>HOME/MENU</b>	Press to display the menu with TV functions and settings. See "Using the Menus" on page 48.
9 <b>NETFLIX</b>	Press to display the NETFLIX menu.
10 <b>0-9</b>	Press <b>0-9</b> to select a channel.
11 	Use with <b>0-9</b> to select digital channels. For example, to enter 2.1, press (2), (.), (1) and (+).
12 <b>MUTING</b>	Press to mute the sound. Press again or press <b>VOL +</b> to restore the sound.
13 <b>VOL (▲) +/-</b>	Press to adjust the volume.
14 <b>POWER</b> 	Press to turn on and off the TV.



- When you set **Scene Select** to **Photo**, **Music**, **Cinema**, **Game** or **Sports**, **Sound Mode** is automatically set to **Standard**.
- The scene select function is not compliant with USB/DLNA-Photo, -Music, -Video, IPTV, Yahoo! Widgets and Internet Browser.

Button	Description
15 <b>SYNC MENU</b>	Press to display the <b>BRAVIA Sync Menu</b> and then select connected HDMI equipment from <b>HDMI Device Selection</b> .
16 <b>SEN</b>	Enables selection of content from the online service "SEN" (Sony Entertainment Network). If "SEN" is unavailable, the "SEN" category is not displayed.
17 <b>DISPLAY</b>	Press once to display the banner with channel/program information you are watching. The banner will time out in a few seconds or press again to exit.
18 <b>▲/▼/◀/▶</b> <b>+</b>	Press <b>▲/▼/◀/▶</b> to move focus/highlight. Press <b>+</b> to select/confirm an item.
19 <b>OPTIONS</b>	Press to display a list of convenient functions and menu shortcuts. The options menu items vary based on current input and content.
20 <b>INTERNET APPS</b>	Press to display the Yahoo! Widgets.
21 <b>CC/ SUBTITLE</b>	Press to cycle through the available settings for <b>Closed Captions (CC) : On, Off, and On when Muting</b> .
22 <b>JUMP</b>	Press to jump back and forth between two channels and external inputs. The TV alternates between the current/last channel or external input selected.
	
23 <b>CH +/-</b>	Press to scan through channels. To scan quickly through channels, press and hold down either <b>CH +/-</b> .

# TV Controls and Indicators

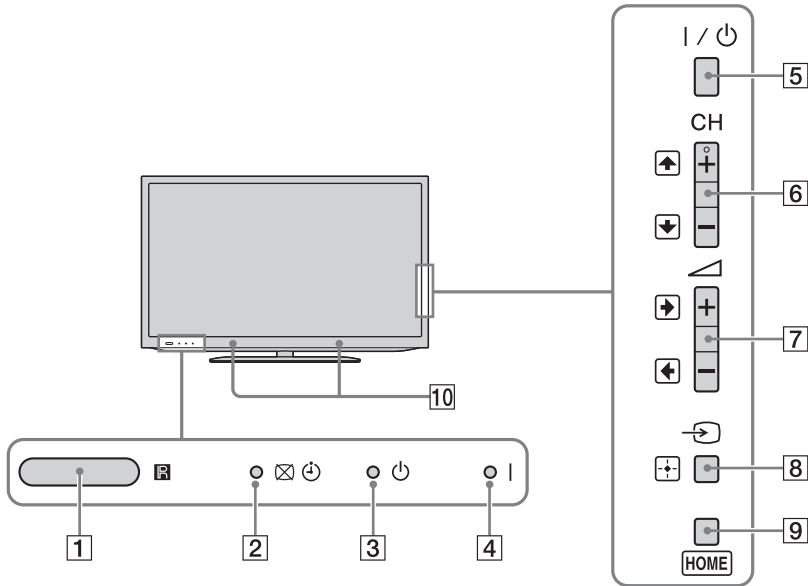

Item	Description
1	<b>Light sensor (IR) Infrared Receiver</b> Senses room light level and adjusts the screen brightness accordingly. Do not put anything over the sensor, doing so may affect its function. Receives IR signal from the remote control.
2	<b>☒ (Picture Off)/⏻ (Timer) LED</b> Lights up in orange when the <b>On Timer/Sleep Timer/Photo Frame</b> is set. If you set to <b>On Timer</b> , lights up in orange while the TV is also in standby mode. Lights up in green when the <b>Power Saving</b> is set to <b>Picture Off</b> .
3	<b>⏻ (Standby) LED</b> Lights up in red when the TV is in standby mode.
4	<b>I (Power) LED</b> Lights up in green when the TV is turned on.
5	<b>I/⏻ (Power)</b> Press to turn on and off the TV.
6	<b>CH</b> <b>+</b> Press to scan through channels. To scan quickly through channels, press and hold down either <b>CH -/+</b> . In the menu screen, these buttons serve as up/down buttons.
7	<b>-</b> <b>+</b> Press to adjust the volume. In the menu screen, these buttons serve as left/right buttons.
8	<b>↔</b> <b>↪</b> <b>(Input)</b> Press to display the list of external inputs. Press repeatedly to toggle through the inputs. In the menu screen, this button serves as confirming the selection or setting.
9	<b>HOME</b> Press to display menu with TV functions and settings (see “Using the Menus” on page 48).



- For more information about setting up the external inputs labels, see page 63.
- The **CH +** button has a tactile dot. Use it as a reference when operating the TV.
- Make sure that the TV is completely switched off before unplugging the power cord.

# BRAVIA® Sync™ with Control for HDMI

With the **Control for HDMI** function, **BRAVIA Sync** helps to communicate with **BRAVIA Sync**-compatible equipment using HDMI CEC (Consumer Electronics Control). Use the following settings and tips to help unify control of your connected equipment.

- 1 Press **HOME** and select **Settings**, then select the **Setup** settings.
- 2 Select the **HDMI Settings**, then highlight **Control for HDMI**, and set to **On**.

## ■ Controlling BRAVIA Sync-Compatible Equipment

To control the equipment by using the remote control, press **SYNC MENU** and select the desired equipment from **HDMI Device Selection**.



## ■ BD/DVD Player

- Automatically turns the **BRAVIA Sync**-compatible equipment on and switches the input to that equipment when you select it from the **Sync Menu**.
- Automatically turns the TV on and switches the input to the connected equipment when the equipment starts to play.
- Automatically turns the connected equipment off when you switch the TV to standby mode.

## ■ AV Amplifier

- Automatically turns the connected AV amplifier on and switches the sound output from the TV speaker to the audio system when you turn the TV on.
- Automatically switches the sound output to the AV amplifier by turning the AV amplifier on when the TV is turned on.
- Automatically turns the connected AV amplifier off when you switch the TV to standby mode.
- Adjusts the volume (**VOL +/-**) and mutes the sound (**MUTING**) of the connected AV amplifier through the TV's remote control.

## ■ Video Camera

- Automatically turns the TV on and switches the input to the connected video camera when the connected video camera is turned on.
- Automatically turns the connected video camera off when you switch the TV to standby mode.



- **Control for HDMI (BRAVIA Sync)** is only available for the connected Sony equipment that has the **BRAVIA Sync** or is compatible with **Control for HDMI**.
- The **Control for HDMI** settings must be set on both the TV and connected equipment. For settings on the connected equipment, refer to their instruction manuals.
- When specific Sony equipment compatible with **Control for HDMI (BRAVIA Sync)** is connected, **BRAVIA sync** is automatically activated on the equipment.

# Using PIP Feature

**PIP** (picture in picture) displays a picture from a connected PC in full screen, and a TV program or other external input (see below “To Enter PIP” table) in an inset window. (**Closed Captions (CC)** is not available with **PIP** mode.)



## To Enter PIP

PIP Supported Inputs	
In main window	In sub window
PC	TV channel (CABLE/ANTENNA), VIDEO IN 1/2, HDMI IN 1/2/3/4 (video timing)
HDMI IN (PC timing)	TV channel (CABLE/ANTENNA), VIDEO IN 1/2, COMPONENT IN

- 1 Press **OPTIONS** while in the PC mode.
- 2 Select **PIP** from the **OPTIONS** menu.
- 3 The sub window will appear.

## ■ To Change Channels

You can change the channel of the sub window by pressing **CH +/-** or entering the channel number using the **0-9** numeric buttons.

## ■ To Exit from PIP

- 1 Press **OPTIONS**.
- 2 Press  $\uparrow/\downarrow$  to highlight **Exit PIP** and press  $\oplus$  to exit to full PC screen.

## ■ To Swap Audio

You can swap audio between the main and sub window.

- 1 Press **OPTIONS**.
- 2 Press  $\uparrow/\downarrow$  to highlight **Audio Swap** and press  $\oplus$ .
- 3 Press  $\uparrow/\downarrow$  to highlight the window to be audible, then press  $\oplus$ .

# Using PAP feature

**PAP** (picture and picture) displays two pictures (left and right) on the screen simultaneously (e.g. external input and TV program). For details on external equipment, see page 17.



## To Enter PAP

PAP Supported Inputs	
In main window	In sub window
Component	TV channel (CABLE/ANTENNA), VIDEO IN 2
HDMI IN (except PC timing)	TV channel (CABLE/ANTENNA), VIDEO IN 1/2, COMPONENT IN

- 1 Press **OPTIONS** and then select **P&P**.
- 2 Press **◀/▶** to select active picture.

### ■ To change channels

You can change the channel of the sub window by pressing **CH +/-** or entering the channel number using the **0-9** numeric buttons.

### ■ To swap main window or sub window

You can swap between the main and sub window by pressing **◀/▶**.

### ■ To change the picture size

You can change the picture size by pressing **▲/▼** buttons.

### ■ To Exit from PAP

You can exit from PAP, using any of the following methods:

- ① Press **RETURN**.

- ② Press **▲/▼** to highlight **Single Picture** and press **⊕** to exit to Single Picture from Options menu.
- ③ Press **⊕**.



# Favorites

Your favorite channels and external inputs can be accessed by pressing the **HOME** button once they are added to the list.

- 1 Press **HOME**.
- 2 Press **▲/▼** to select **Favorites**, then press **⊕**.

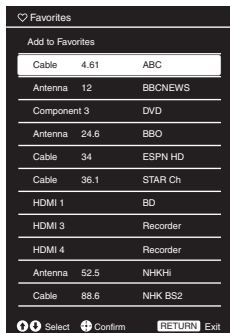

The favorites list appears.

- 3 Press **▲/▼** to select a channel or input, then press **⊕**.

## ■ To add to Favourites

While tuned to the channel you want to watch or viewing connected equipment, press **HOME** and select **Favorites** to display the list. Highlight **Add to Favorites**, then press **⊕**. Your newly added item will be listed at the top of the list. When you continue to add items beyond the 10th item, the item listed at the bottom of the list will be automatically removed from the list.



- Favorite channels and external inputs can also be added using the **OPTIONS** button on the remote control.
- Your **Favorites** list will be cleared each time you run the **Auto Program**.

# Wide Mode

The **Wide Mode** feature allows you to select the screen display of your preference. Based on the original signal source, you may see black bars around the picture or just on the both sides of the screen. Sometimes you will see the picture filled or with the full screen. This is due to the signals your TV receives.







You can manually select available **Wide Mode** settings as you watch your TV by pressing the **WIDE** button on your remote control or you can set your TV to **Auto Wide**.

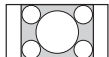

## ■ To set Auto Wide

Press **HOME** and select **Settings**, then select the **Screen** settings. Select **Auto Wide** and set to **On**.

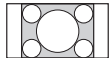
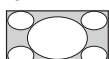
## ■ To change the Wide Screen Mode

Press **WIDE** repeatedly to cycle through the available modes.

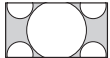
4:3 Original source	16:9 Original source
Standard-definition source 	High-definition source 
<b>Wide Zoom</b> 	<b>Wide Zoom</b> 
<b>Normal</b> 	<b>Normal</b> This mode is not available.
<b>Full</b> 	<b>Full</b> 

4:3 Original source	16:9 Original source
<b>Zoom</b> 	<b>Zoom</b> 

**Normal** is available with 480i or 480p sources only.

## Wide Mode with PC

**Wide Mode** is also available for the **PC** settings. When a PC is connected to the TV and **PC** input is selected, you can change the PC Screen settings.

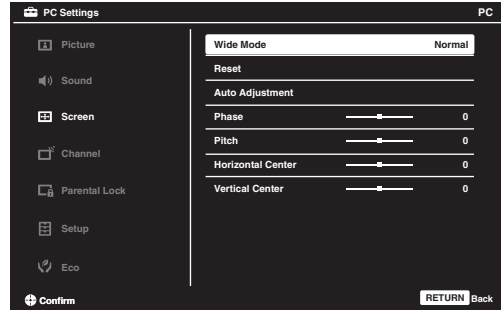

### ■ To change the Wide Screen Mode for PC Timing

Press **WIDE** repeatedly to cycle through the available modes while in the PC input mode.

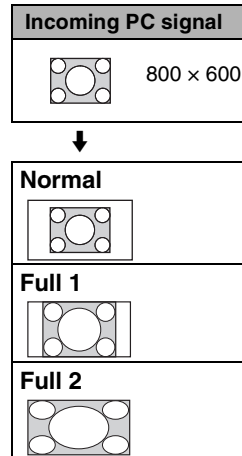

- Use the **Auto Adjustment** to adjust the display position and phase of the picture when the TV receives an input signal from the connected PC.

# Inputs

Press **INPUT** to display the **Input** menu and toggle through the external inputs to select your video signal for viewing including the TV mode. The inputs list consists of TV mode and other equipment connected to the TV.

You can label your external inputs to identify them easily.

## ■ To Manage on Input

Press **HOME** and select **Settings**, then select the **Setup** settings. Select the **Manage Inputs** option in **AV Setup**. Press **▲/▼** to highlight the video input (**HDMI 1-4, Video 1-2, Component, PC**) to which you want to assign a label; press **⊕** to select the input of your choice.

## ■ To Manage Label

Press **◀/▶** to highlight one of the displayed labels that corresponds to your connected equipment, then press **⊕**.

## ■ To Manage Enable

- 1 Press **◀/▶** to select enable column.
- 2 Press **▲/▼** to select **Auto, Always** or **Off** when **Auto** is selected. The selected input will be listed always.

# Playing back Photo/ Music/Video via USB

You can enjoy photo/music/video files stored in a Sony digital still camera or camcorder through a USB cable or USB storage device on your TV.

- 1 Connect a supported USB device to the TV.
- 2 Press **HOME**.
- 3 Press **▲/▼** to select **Media**, then press **▲/▼/◀/▶** to select **Photo, Music, Video**, then press **⊕**.
- 4 Press **▲/▼/◀/▶** to select a file, folder or device, then press **⊕**.  
When you select a folder, select a file, then press **⊕**.  
Playback starts.

## ■ Photo Playback Auto Start

The TV automatically displays the thumbnail view screen when the TV is turned on and a digital still camera or other device storing photo files is connected to the USB port then turned on (page 61).

## ■ Notes when playing back files

- While the TV is accessing the data on the USB device, observe the following:
  - Do not turn off the TV or connect USB device.
  - Do not disconnect the USB cable.
  - Do not remove the USB device.

The data on the USB device may be damaged.

- Sony will not be held liable for any damage to, or loss of, data on the recording media due to a malfunction of any connected devices or the TV.
- Playback does not start automatically if the TV is turned on after connecting the digital still camera or other device to the USB port.
- The USB device supports FAT16, FAT32 and NTFS.
- Photo Playback Auto Start works only for photo files in the newest digital still camera folder (DCF-compliant, highest-numbered “DCIM” folder).
- Playback may not start automatically when some digital still cameras (such as cameras with internal memory) are connected.
- The file name and folder name support only English.
- When you connect a Sony digital still camera, set the camera’s USB connection mode to “Auto” or “Mass Storage.” For more information about USB connection mode, refer to the instructions supplied with your digital camera.
- Use a USB storage device that is compliant with USB Mass Storage Class standards.
- If a selected file has incorrect container information, or is incomplete, it cannot be played back.

**USB Video format**

Extension	Container	Video Codec	Audio Codec
.avi	AVI	XviD	PCM / MPEG1 Layer1, 2 / MP3 / MPEG2 AAC (2ch) / MPEG4 AAC (2ch) / MPEG4 HE-AAC (2ch) / Dolby Digital (2ch) / WMA v8
		MPEG1	
		MPEG2 MP	
		H.264 BP/MP/HP	
		MPEG-4 SP/ASP	
.wmv .asf	ASF	WMV v9	MP3 / WMA v8
		XviD	
		MPEG-4 SP/ASP	
.mp4 .mov .3gp	MP4	VC-1	MPEG1 Layer1, 2 / MP3 / MPEG2 AAC / MPEG4 AAC / MPEG4 HE-AAC
		H.264 BP/MP/HP	
		MPEG-4 SP/ASP	
.mkv	MKV	H.264 BP/MP/HP	PCM / MPEG1 Layer1, 2 / MP3 / MPEG2 AAC (2ch) / MPEG4 AAC (2ch) / MPEG4 HE-AAC (2ch) / Dolby Digital (2ch) / WMA v8
		MPEG-4 SP/ASP	
		WMV v9	
		VC-1	
.mpg .mpeg .vob .vro	PS	MPEG1	MPEG1 Layer1, 2 / MP3 / Dolby Digital (2ch)
		MPEG2 MP	
		MPEG2 MP	
.ts, .m2ts	TS	MPEG2 MP	MPEG1 Layer1, 2 / MP3 / MPEG2 AAC (2ch) / MPEG4 AAC (2ch) / MPEG4 HE-AAC (2ch)
		VC-1	
		H.264 BP/MP/HP	

**USB Music format**

Extension	Audio Codec
.mp3	MP3
.wma	WMA v8

**USB Photo format**

Extension	Image Codec
.jpg, .jpeg	JPEG

DCF2.0 or EXIF2.21 supported.

 • Playback of the above file formats is not guaranteed.

# Home Network

## Connecting to a Home Network

You can enjoy various content (e.g. photo/music/video files) stored on DLNA Certified™ media servers. The home network feature allows you to enjoy network content in other rooms.

### ■ Playing photo/music/video

- 1 Press **HOME**, then select **Media** > **Photo**, **Music** or **Video** > the desired media server.
- 2 Select files or folders to play from the list.



- The server is required to be DLNA Certified™.
- Files from a network device need to be in the following formats:
  - Still images: JPEG
  - Music: MP3, linear PCM, WMA
  - Video: AVCHD, MPEG2, MPEG1, MP4 (AVC), MP4 (MPEG4), WMV
- Depending on the file, playback may not be possible even when using the supported formats.

## Renderer

You can play back photo, music and video files stored in network devices (e.g. digital still cameras, mobile phones, PC) on the TV screen by directly operating the target device. The network should also be renderer-compatible.

### ■ Adjusting the renderer settings

Press **HOME**, then select **Settings** > **Setup** > **Network** > **Home Network Setup** > **Renderer** > the desired setting.

## Display Settings for Media Servers

Select home network servers to be displayed in the Home Menu. Up to 10 servers can be displayed in the Home Menu automatically.

- 1 Press **HOME**, then select **Settings** > **Setup** > **Network** > **Home Network Setup** > **Show/Hide Media Servers**.
- 2 Select the server to display in the Home Menu.

# Photo Frame

You can enjoy looking at a photo, listening to music, or the clock and calendar, at the same time.

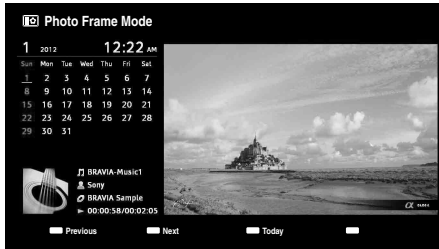

You can enter or exit photo frame mode using any of the following methods:

- 1 Press **HOME**, and then select **Photo Frame Mode**.
- 2 Press **Photo Frame**.
- 3 Press **OPTIONS**, when you are playing back the photo/music files.

You can switch the frame, e.g. image and clock, full screen image or full screen clock.

For more details, see page 61.

## ■ To select photo

You can select photos from USB memory or the DLNA Certified™ server, using any of the following methods:

- 1 Press **HOME** and select **Settings**, then **Setup > Photo Frame Settings > Image Selection**. Select the device/server and then press the blue button or (+) to select the file from thumbnail view.
- 2 In photo frame mode, press **OPTIONS > Image Selection**. Select the device/server and then press the blue button or (+) to select the file from thumbnail view.

- 3 Press **HOME**, and then select **Media**, then select **Photo**. When playing back a photo, press **OPTIONS > Photo Frame Mode** to launch **Photo Frame** with the selected photo.

## ■ To select music

You can select music from USB memory or the DLNA Certified™ server, using any of the following methods:

- 1 Press **HOME** and select **Settings**, then **Setup > Photo Frame Settings > Music Selection**. Select the device/server and then press (+) to select the file from thumbnail view.
- 2 In photo frame mode, press **OPTIONS > Music Selection**. Select the device/server and then press (+) to select the file from thumbnail view.
- 3 Press **HOME**, and then select **Media**, then select **Music**. When playing back music, press **OPTIONS > Photo Frame Mode** to launch **Photo Frame** with the selected music.

## ■ To select Display mode

You can change the photo frame display by selecting **Display Mode** (page 61).

### • Image and Clock



### • Full Screen Image



### • Full Screen Clock



### ■ To select Clock Display mode

There are five calendar display modes. When the **Display Mode** setting is set to **Image and Clock**, you can set to **Calendar**, **Analog Clock** or **Digital Clock**. When the **Display Mode** setting is set to **Full Screen Clock**, you can set to **Calendar**, **Calendar and Clock** or **Clock**. For more details, see page 61:

- **Calendar**
- **Analog Clock**
- **Digital Clock**
- **Calendar and Clock**
- **Clock**

### ■ Duration

To save power, photo frame mode will shut down after 24 hours of TV with power off automatically. After running photo frame mode for 24 hours, not use this mode for at least one hour, to avoid panel burn-in.

Duration time can be set to **Duration** in **Photo Frame Settings**. For more details, see page 61.

To avoid panel burn-in, the position of the photo, clock and calendar are switched automatically every hour.

## Using Home Network Features

When you connect this TV to the Internet, you can enjoy multiple functions: enjoying Internet video, etc.



- You will need to contract with an Internet service provider to connect to the Internet.

### Preparing a Wired Network

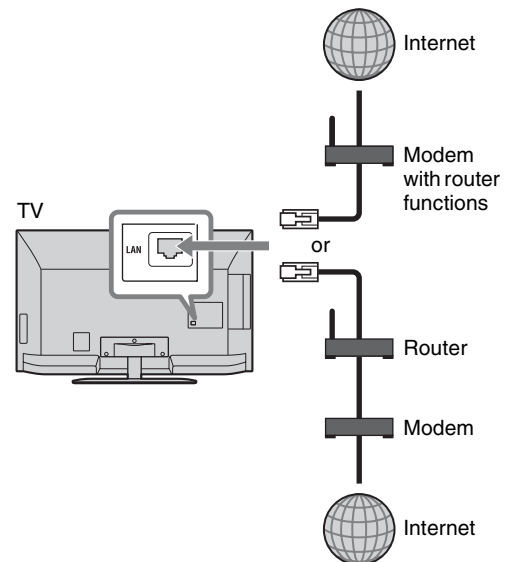

- For LAN connections, use a Category 7 cable (not supplied).



## Preparing a Wireless LAN

Wireless LAN Ready lets you easily access the Internet and your home network with the USB Wireless LAN Adapter UWA-BR100. By inserting the USB Wireless LAN Adapter into your TV's USB port, you can easily create a cable-free network. Before setting up the wireless LAN function of the TV, be sure to set up a wireless LAN router.

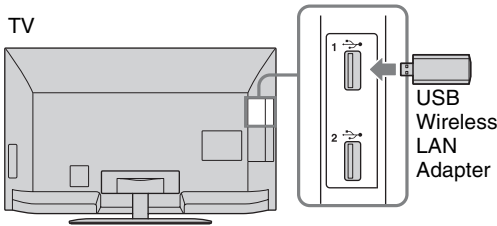

- It is recommended that the USB Wireless LAN Adapter UWA-BR100 be inserted in USB 1.

## Setting up the Internet Connection

Using the network feature you can connect the TV to the Internet. The set-up procedure differs depending on the type of network and LAN router. Before setting up the Internet connection, be sure to set up a LAN router. Check your wireless LAN environment using the following chart.

### Wireless LAN

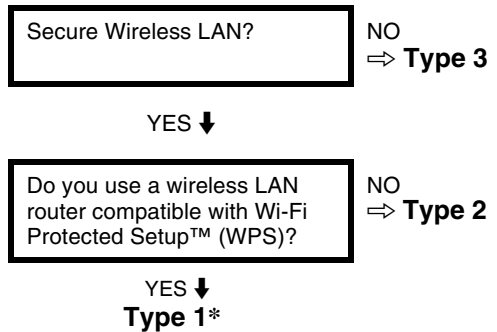

### Wired LAN → Type 4

\* Type 1 is easier to set up if your router has an automatic setting button, e.g. Air Station One-Touch Secure System (AOSS). Most of the latest routers have this function. Check your router.

**Type 1:** Follow the configuration for **Secured network with Wi-Fi Protected Set-up™ (WPS)**.

**Type 2:** Follow the configuration for **Secured network without Wi-Fi Protected Set-up™ (WPS)**.

**Type 3:** Follow the configuration for **Unsecured network with any type of wireless LAN router**.

**Type 4:** Follow the configuration for **Wired network set-up**.

## Type 1: Secured network with Wi-Fi Protected Setup™ (WPS)

The WPS standard makes security of a wireless home network as straightforward as pressing the WPS button on the wireless LAN router. Before setting up a wireless LAN, check the location of the WPS button on the router and verify how to use it.

For security purpose, **WPS (PIN)** provides a PIN code for your router. PIN code is renewed every time you select **WPS (PIN)**.

- 1 Press **HOME**, then select **Settings > Setup > Network > Network Setup**.
- 2 IP Address setting/Proxy server:
  - automatic setting:  
**Setup network connection > Auto**
  - manual setting:  
**Setup network connection > Custom > Wireless Setup**
- 3 Select **WPS (Push Button)** for Push Button method or **WPS (PIN)** for PIN method.



- Button name of the WPS may differ depending on the router (e.g. AOSS button).
- 4 Follow the instructions on the set-up screen.

## Type 2: Secured network without Wi-Fi Protected Setup™ (WPS)

To set up a wireless LAN, SSID (wireless network name) and security key (WEP or WPA key) will be required. If you do not know them, consult the instruction manual of your router.

- 1 Press **HOME**, then select **Settings > Setup > Network > Network Setup**.
- 2 IP Address setting/Proxy server:
  - automatic setting:  
**Setup network connection > Auto**
  - manual setting:  
**Setup network connection > Custom > Wireless Setup**
- 3 Select **Scan**, then select a network from the list of scanned wireless networks.
- 4 Follow the instructions on the set-up screen.



- If you use WPS for network set-up, the security settings of the wireless LAN router activate, and any equipment previously connected to the wireless LAN in a non-secure status will be disconnected from the network. In this case, activate the security settings of the disconnected equipment and then reconnect. Or, you can deactivate the security settings of the wireless LAN router, and then connect the equipment to a TV in a non-secure status.

## Type 3: Unsecured network with any type of wireless LAN router

To set up a wireless LAN, SSID (wireless network name) will be required.

- 1** Press **HOME**, then select **Settings > Setup > Network > Network Setup**.
- 2** IP Address setting/Proxy server:
  - automatic setting:  
**Setup network connection > Auto**
  - manual setting:  
**Setup network connection > Custom > Wireless Setup**
- 3** Select **Scan**, then select a network from the list of scanned wireless networks.
- 4** Follow the instructions on the set-up screen.



- Security key (WEP or WPA key) will not be required because you do not need to select any security method in this procedure.

## Type 4: Wired network set-up

Enter the respective alphanumeric values for your router if necessary. The items that need to be set (e.g. IP Address, Subnet Mask, DHCP) may differ depending on the Internet service provider or router. For details, refer to the instruction manuals provided by your Internet service provider, or those supplied with the router.

- 1** Press **HOME**, then select **Settings > Setup > Network > Network Setup**.
- 2** IP Address setting/Proxy server:
  - automatic setting:

**Setup network connection > Auto**

– manual setting:

**Setup network connection > Custom > Wired Setup**

- 3** Follow the instructions on the set-up screen.

**Network Setup** can also be set from **Initial Setup** menu.

- Allows automatic configuration of your wired/wireless network.
  - When connecting with LAN cable: **Wired**
  - When connecting with USB Wireless adaptor: **Wireless**
  - When connecting with both of the cables: **Wired**
- Set to **Auto**, sets the IP address automatically. For proxy server is not use.

## Viewing the network status

You can confirm your network status.

- 1** Press **HOME**, then select **Settings > Setup > Network > Network Setup**.
- 2** Select **View Network settings and status**.

## If You Cannot Connect to the Internet

Use the diagnosis to check possible causes for network connection failures, and settings.

- 1 Press **HOME**, then select **Settings > Setup > Network > Network Setup**.
- 2 Select **View Network settings and status**.
- 3 Select **Check Connection**.  
This may take several minutes. You cannot cancel the diagnosis after selecting **Check Connection**.

## Adjusting the Server Display Settings

You can select home network servers to be displayed on the Home Menu. Up to 10 servers can be displayed in the Home Menu automatically.

- 1 Press **HOME**, then select **Settings > Setup > Network > Home Network Setup**.
- 2 Select **Show/Hide Media Servers**.
- 3 Select the server you want to display on the Home Menu, and adjust the settings.

### ■ If you cannot connect to your home network

The TV detects if the server is being correctly recognised when you cannot connect it to your home network. If the diagnostic results indicate a failure, check possible causes, and network connections and settings.

- 1 Press **HOME**, then select **Settings > Setup > Network > Home Network Setup**.
- 2 Select **Media Server Troubleshooting**.  
Press **Yes**, then the server diagnostic starts. When the server diagnostic is complete, the diagnostic result list appears.

# Browsing Websites

When the TV is connected to the Internet, you can browse websites.

Press **HOME**, then select **Internet Browser** to launch the browser.

You can bookmark your favorite sites for easy access.



- Web content may not be displayed correctly, or some functions may not work properly, if the TV does not support functions provided by certain Internet services. Also, the TV may not support functions developed in the future.

## ■ Note on Internet Browser

In no event shall Sony be liable for any damage caused or associated with the use of Internet browser, malfunction (including software) or communication failure.

# Enjoying Sony Entertainment Network

Sony Entertainment Network serves as a gateway to Internet content, delivering a variety of on-demand entertainment straight to your TV. By making a broadband Internet connection, you can enjoy video content, including movies and cartoons.



- Be sure to connect your TV to the broadband Internet and complete **Network Setup** (page 60).

## ■ To Use Sony Entertainment Network

- 1 Press **HOME**, then select **Internet Contents > Internet Video**.
- 2 Press **▲/▼/◀/▶** to select the desired video service in Service list and press **⊕**.
- 3 Highlight the desired content, then press **⊕**.

## ■ To exit Sony Entertainment Network

Press **HOME**.

## ■ To launch Internet Video

Internet Video can also be launched by pressing the **SEN** button on the remote control.



- If you experience difficulties with this feature, check that the Internet connection is set up properly.
- Information about the highlighted icon appears in the information banner.
- The interface to Internet content depends on the Internet content providers.
- Services block video content is based on the "Parental Lock" setting of the TV. Some service providers do not support this function (page 57).

(Continued) **45**

- To update Sony Entertainment Network content services, Press **HOME**, then select **Settings > Setup > Network > Refresh Internet Content**.

### ■ Seeking forward/backward in video content

Press the buttons on the remote controls that correspond with the control indications on the screen.



Control indications

### ■ To use NETFLIX

Press **NETFLIX** button on the remote control to launch menu.

### ■ To use YouTube Leanback

Follow the steps in “**To Use Sony Entertainment Network**” (page 45) to launch **Sony Entertainment Network**, then select YouTube to launch the YouTube Leanback.



- It is possible that Netflix cannot be used via a Proxy server.

## Enjoying Yahoo! Widgets

With the Widgets feature, you can display a variety of information on the screen. Widgets are small downloadable applications that provide easy access to interactive content when your TV is connected to the Internet.



- Be sure to connect your TV to the Internet, and complete **Network Setup**.
- If you experience difficulties with this feature, check that the Internet connection is set up properly.
- This feature may not be available in some regions/countries.
- Available Widgets depend on your region/country.
- MAC address and IP address are transmitted automatically from the TV to servers while an Internet connection is available. The servers are under the control of Sony, and MAC address will never be transmitted to servers controlled by other parties.
- It is possible that Yahoo! Widgets cannot be used via a Proxy server.

- 1 Press **HOME**.
- 2 Press **▲/▼** to select **Applications**, and press **⊕**.
- 3 Select the desired Widget to display on the screen.

You can access Yahoo! Widgets by pressing the **INTERNET APPS** button.

### ■ To activate additional Widgets

- 1 Press **HOME**.
- 2 Press **▲/▼** to select **Applications**, and press **⊕**.
- 3 Press **◀/▶** to select **CONNECTED TV STORE**, and press **⊕**.

**4** Select the desired Widget to activate.

■ **To launch Yahoo! Widgets**

Yahoo! Widgets can also be launched by pressing the **SEN** button on the remote control.

# Navigating through TV Menus

The **HOME** button allows you to access a variety of TV settings and USB media files.

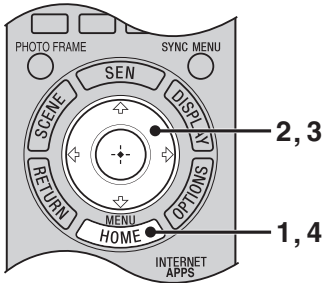





- 1 Press  on the remote control to display the menu options.
- 2 Press  to navigate on the menu or adjust the settings.
- 3 Press  to select or confirm.
- 4 Press  to exit.



Photo Frame Mode

You can select the frame image which enables you to enjoy with photo, music and clock. For details, see page 39.



Internet Contents

Enables access to Internet services for TV. For details, see page 45.



Applications

Internet Apps are small downloadable applications that provide easy access to interactive content when your TV is connected to the Internet. You can display a variety of information on the screen.

Internet Apps may not be available in some region/country. For details, see page 46.



Internet Browser

When the TV is connected to the Internet, you can browse websites. Select the browser and enter a URL.



Favorites

The Favorites feature provides quick access to your frequently used items, such as preferred TV channels or external inputs (e.g. game console, DVD player). For details, see page 33.





Media



Photo



Music



Video

The **Photo**, **Music**, and **Video** icons organize your photo, music, and video files from DLNA Certified™ networked equipment or Sony USB connected equipment. Be sure to select the correct icon when accessing files. Refer to the feature section for more information on these icons.



Settings

The **Settings** icon contains all of the necessary configurations to customize your TV settings. The options you can select may vary. Unavailable options are grayed out or not displayed.



**Picture:** adjust the picture on your TV to fit your viewing preference.



**Sound:** customize your sound settings to suit your audio preference. You can also change the settings to output the sound to your connected audio equipment.



**Screen:** adjust the size and shape of the images you see on the screen.



**Channel:** navigate your favorite channels and inputs and select the signal type, as well as autoprogram channels. You can also customize the channels you see and the labels assigned to them.



**Parental Lock:** set the password and limit access to programming based on rating levels. You can also block channels and inputs.



**Setup:** modify and customize a variety of general setting options.



**Eco:** changes the settings related to power consumption.

---

## Using the Picture Settings

Option	Description
<b>Picture Mode</b> Customized picture viewing	Displays the options selected in the <b>Scene Select</b> settings (page 26). When <b>Scene Select</b> is set to <b>General</b> , the options below can be selected.
	<b>Vivid</b> Select for enhanced picture contrast and sharpness.
	<b>Standard</b> Select for standard picture settings. Recommended for home entertainment.
	<b>Custom</b> Select to store your preferred settings.
<b>Reset</b>	Resets the current <b>Picture</b> settings to their defaults, except <b>Picture Mode</b> .
<b>Backlight</b>	Adjust to brighten or darken the backlight.
<b>Picture</b>	Adjust to increase or decrease picture contrast.
<b>Brightness</b>	Adjust to brighten or darken the picture.
<b>Color</b>	Adjust to increase or decrease color intensity.
<b>Hue</b>	Adjust to increase or decrease the green tones.
<b>Sharpness</b>	Adjust to sharpen or soften the picture.
<b>Color Temperature</b> White adjustment	<b>Cool</b> Select to give the white colors a bluish tint.
	<b>Neutral</b> Select to give the white colors a neutral tint.
	<b>Warm 1/Warm 2</b> Select to give the white colors a reddish tint. <b>Warm 2</b> gives a redder tint than <b>Warm 1</b> .
<b>Noise Reduction</b>	Select to reduce the picture noise level. Select from <b>Auto</b> , <b>High</b> , <b>Medium</b> , <b>Low</b> and <b>Off</b> .
<b>MPEG Noise Reduction</b>	Select to reduce the picture noise in MPEG-compressed videos. This is effective when viewing a DVD or digital broadcast. Select from <b>High</b> , <b>Medium</b> , <b>Low</b> and <b>Off</b> .
<b>Motionflow</b>	Provides smoother picture movement and reduces picture blur.
	<b>High</b> Provides smoother picture movement such as for film-based contents.
	<b>Standard</b> Provides smooth picture movement. Use this setting for standard use.
	<b>Off</b> Use this setting when the <b>High</b> and <b>Standard</b> settings result in noise.
<b>CineMotion</b>	Provides improved picture movement and reduces picture blur and graininess for film-based content. Select <b>Auto 1</b> to represent original film-based content as is, or <b>Auto 2</b> for standard use. (Setting items vary depending on the TV model.)



- You can change the IPTV picture setting, only when watching Internet video.

Option	Description
<b>Advanced Settings</b>	<b>Reset</b> Resets the advanced settings to the default values.
	<b>Adv. Contrast Enhancer</b> Automatically adjusts backlight and contrast to the most suitable settings judging from the brightness of the screen. This setting is especially effective for dark scenes, and will increase the contrast distinction of the darker picture scenes. Select from <b>High, Medium, Low</b> and <b>Off</b> .
	<b>Black Corrector</b> Enhances black areas of the picture for stronger contrast. Select from <b>High, Medium, Low</b> and <b>Off</b> .
	<b>Gamma</b> Adjusts the balance between bright and dark areas of the picture.
	<b>Clear White</b> Emphasizes white colors. Select from <b>High, Low</b> and <b>Off</b> .
	<b>Live Color</b> Makes colors more vivid. Select from <b>High, Medium, Low</b> and <b>Off</b> .
	<b>LED Motion Mode</b> Lights up the backlight adequately, reducing blur in movies, but the brightness decreases.
<b>White Balance</b> Adjusts the color temperature in detail.	



- Available **Picture** options, including options in **Advanced Settings** depend on **Scene Select** and **Picture Mode**.

## Using the Sound Settings

Option	Description
<b>Sound Mode</b> Customized sound listening	Sets a sound mode. <b>Sound Mode</b> includes options best suited for video and photographs, respectively. The available options depend on the scene select settings. <hr/> <b>Dynamic</b> Enhances treble and bass. <hr/> <b>Standard</b> Standard sound optimized for home use. <hr/> <b>Clear Voice</b> Suitable for spoken dialog. <hr/> <b>Custom</b> Select to store your preferred settings.
<b>Reset</b>	Resets the current <b>Sound</b> settings to their defaults, except <b>MTS Audio</b> , <b>Alternate Audio</b> and <b>Speakers</b> .
<b>Equalizer</b>	<b>Adjust</b> allows you to select your frequency response curve. Select <b>Reset</b> to reset the <b>Equalizer</b> settings to the default values.
<b>Balance</b>	Adjust to emphasize left or right speaker balance.
<b>Steady Sound</b>	Select <b>On</b> to stabilize the volume across all programs and commercials. Select <b>Off</b> to disable this function.
<b>Volume Offset</b>	Adjust the volume level of the current input relative to other inputs.
<b>Surround</b>	Allows you to select the suitable surround effects depending on the genre of TV program (movie, sport, music, etc.) or video game. The available options depend on the scene select setting. <hr/> <b>On/Off</b> Select <b>On</b> to optimize the sound quality to enjoy the effects of the Surround option and to create a virtual surround sound using the 2ch speaker. <hr/> <b>Cinema/Off</b> Provides surround effects just like the high-grade audio systems found in movie theaters. This option is available when you select <b>Cinema</b> in the scene select setting. <hr/> <b>Music/Off</b> Provides surround effects that make you feel like you are surrounded by sound as in a music hall. This option is available when you select <b>Photo</b> or <b>Music</b> in the scene select setting. <hr/> <b>Sports/Off</b> Provides surround effects that make you feel like you are watching a live sports contest. This option is available when you select <b>Sports</b> in the scene select setting. <hr/> <b>Game/Off</b> Provides surround effects that enhance game sound. This option is available when you select <b>Game</b> in the scene select setting.
<b>Bass Booster</b>	Produces a fuller sound for more impact, by emphasizing the bass sounds.

Option	Description
<b>MTS Audio</b> Enjoy stereo, bilingual and mono programs	<b>Stereo</b> Select for stereo reception when viewing a program broadcast in stereo.
	<b>Auto SAP</b> Select to automatically switch the TV to second audio programs when a signal is received. If no <b>SAP</b> signal is present, the TV remains in <b>Stereo</b> mode.
	<b>Mono</b> Select for mono reception. Use to reduce noise during weak stereo broadcasts.
<b>Alternate Audio</b> Digital channels only	Select among the available options to switch among the alternate audio streams. The program you are tuned to may be broadcasted in a different language in the alternate audio streams.
<b>Speakers</b>	<b>TV Speakers</b> Select to use the TV speakers.
	<b>Audio System</b> Select to use an external audio system for the TV sound. By selecting this option you are disabling the TV speakers.
<b>Audio Out</b>	<b>Variable</b> Adjusts the volume with the TV's remote control, when using an external audio system.
	<b>Fixed</b> Adjusts the volume using the connected audio system's remote control.
<b>HDMI/DVI Audio Source</b>	Sets the audio signal source for HDMI/DVI input.
	<b>Auto</b> Automatically sets the audio signal source based on the video signal.
	<b>HDMI Audio</b> Sets the HDMI input as the audio signal source.
	<b>PC Audio</b> Sets the PC/HDMI audio input as the audio signal source.



- **MTS Audio** is only available for analog programs.
- **Alternate Audio** is only available if the program is broadcast with alternate audio streams.
- You can also access **Sound Mode**, **MTS Audio** and **Alternate Audio** by using the **OPTIONS** button on the remote control.

## Using the Screen Settings

Option	Description
<b>Wide Mode</b>	<b>Wide Zoom</b> Fills the screen with minimum distortion.
	<b>Normal</b> Select to display 4:3 picture in original size when the original source is 4:3.
	<b>Full</b> Select to enlarge the picture horizontally to fill the screen when the original source is 4:3 (Standard definition source). When the original source is 16:9 (High-definition source), select this mode to display the 16:9 picture in its original size.
	<b>Zoom</b> Select to enlarge the original picture without distorting the aspect ratio.
<b>Auto Wide</b>	<b>On</b> Select <b>On</b> to automatically change <b>Wide Mode</b> setting based on the content.
	<b>Off</b> If frequent screen changes are disturbing to you, select <b>Off</b> . Choose one of the <b>Wide Mode</b> options when this function is set to <b>Off</b> .
<b>4:3 Default</b> Select the default Screen Mode to use for 4:3 sources	<b>Wide Zoom</b> Enlarges the 4:3 picture to fill the 16:9 screen, displaying as much of the original image as possible.
	<b>Normal</b> Select to display the 4:3 picture in its original size.
	<b>Off</b> Select to continue using the current <b>Wide Mode</b> setting when the channel or input is changed.
<b>Auto Display Area</b>	Automatically adjusts the picture to the most appropriate display area.
<b>Display Area</b>	Each setting depends on the resolution you are watching.
	<b>Full Pixel</b> Displays pictures in their original size when parts of the picture are cut off (available depending on the TV model).
	<b>+1</b> Displays pictures in their original size.
	<b>Normal</b> Displays pictures in their recommended size.
	<b>-1</b> Enlarges the picture so that the edges are outside the visible display area.
<b>Horizontal Center</b>	Allows you to move the position of the picture left and right. (Available in <b>Wide Zoom</b> and <b>Zoom</b> .)
<b>Vertical Center</b>	Allows you to move the position of the picture up and down. (Available in <b>Wide Zoom</b> and <b>Zoom</b> .)



- **Normal** in the **4:3 Default** setting is not available when you are watching a 720p, 1080i or 1080p source.
- If **4:3 Default** is set to anything but **Off**, the **Wide Mode** setting changes only for the current channel. When you change channels (or inputs), **Wide Mode** is automatically replaced with the **4:3 Default** setting for 4:3 sources. To retain the current **Wide Mode** setting as channels and inputs are changed, set **4:3 Default** to **Off**.
- **4:3 Default** is not available if **Auto Wide** is set to **Off**.

Option	Description						
<b>PC Settings</b>	When a PC is connected to the TV and the PC input is selected, the <b>PC</b> settings screen appears instead of the <b>Screen</b> settings. You can also select the <b>PIP</b> feature which allows you to view two pictures simultaneously from <b>OPTIONS</b> button (page 31).						
<b>Wide Mode</b>	<table border="1"> <tr> <td><b>Normal</b></td> <td>Select to display in the original image size.</td> </tr> <tr> <td><b>Full 1</b></td> <td>Select to enlarge the picture to fill the display area, keeping its original aspect ratio.</td> </tr> <tr> <td><b>Full 2</b></td> <td>Select to enlarge the picture to fill the display area.</td> </tr> </table>	<b>Normal</b>	Select to display in the original image size.	<b>Full 1</b>	Select to enlarge the picture to fill the display area, keeping its original aspect ratio.	<b>Full 2</b>	Select to enlarge the picture to fill the display area.
<b>Normal</b>	Select to display in the original image size.						
<b>Full 1</b>	Select to enlarge the picture to fill the display area, keeping its original aspect ratio.						
<b>Full 2</b>	Select to enlarge the picture to fill the display area.						
<b>Reset</b>	Resets all PC settings to the default values.						
<b>Auto Adjustment</b>	Select to automatically adjust the display position and phase of the picture when the TV receives an input signal from the connected PC. Note that <b>Auto Adjustment</b> may not work well with certain input signals. In such cases, manually adjust the options below.						
<b>Phase</b>	Adjust after <b>Pitch</b> to fine tune overall sharpness.						
<b>Pitch</b>	Adjust uneven sharpness on screen.						
<b>Horizontal Center</b>	Allows you to move the position of the picture left and right.						
<b>Vertical Center</b>	Allows you to move the position of the picture up and down.						



- For the PC Input Signal Reference Chart, see page 67.
- **Auto Adjustment**, **Phase** and **Pitch** are not available with PC signal connected to HDMI input.

# Using the Channel Settings



Option	Description
<b>Signal Type</b>	<b>Cable</b> Select if you are receiving cable channels via Cable TV provider.
	<b>Antenna</b> Select if you are using an antenna.
<b>Auto Program</b>	Automatically sets up the channel list on the TV for all receivable channels. <b>1</b> Select <b>Auto Program</b> . <b>2</b> Select <b>OK</b> to start <b>Auto Program</b> .
<b>Add Digital Channels</b>	<b>1</b> Select <b>Add Digital Channels</b> . <b>2</b> Select <b>OK</b> to add digital channels.
<b>Show/Hide Channels</b>	Allows you to show or hide channels that appear when you use the <b>CH +/-</b> buttons. <b>1</b> Press <b>▲/▼</b> to scroll through the channels until you find the channel you want to show or hide. Then press <b>⊕</b> to select it. <b>2</b> Press <b>▲/▼</b> to determine if the channel will be shown or hidden. Then press <b>⊕</b> to select it.
<b>Edit Channel Labels</b>	Allows you to assign labels (such as station call letters) to channel numbers. <b>1</b> Press <b>▲/▼</b> to scroll through the channel numbers. Then press <b>⊕</b> to select the channel number that you want to assign a label. <b>2</b> Press <b>▲/▼</b> to scroll through the label characters (A-Z, 0-9, etc.). Press <b>▶</b> to move to the next character. Repeat the previous steps to add up to seven characters to the label. When finished, press <b>⊕</b> .
<b>Analog Fine Tune</b>	Allows you to fine-tune the selected analog channel manually if you feel that a slight tuning adjustment may improve picture quality. Select <b>Auto</b> to adjust to the most appropriate analog channel.



- You should run **Auto Program** after changing the **Signal Type** setting.
- Running **Auto Program** will clear the **Favorites** list.
- Channels that you set to be hidden can be accessed by the **0-9** and **⊕** buttons.
- You can set channels to be hidden that are automatically set in **Auto Program**.



# Using the Parental Lock Settings

Option	Description
<b>Password</b>	The <b>Parental Lock</b> settings allow you to set up the TV to block programs according to their content and rating levels. Use <b>0-9</b> on the remote control to enter a four-digit password. The first time you create a password, confirm the password by entering it again.
<b>Change Password</b>	Select to change your password.
<b>Country</b>	<p><b>U.S.A.</b> Select to use U.S.A. ratings (page 58).</p> <p><b>Canada</b> Select to use Canadian ratings (page 59).</p>
<b>Rating</b>	<p><b>Off</b> Turn <b>Parental Lock</b> off. No programs are blocked from viewing.</p> <p><b>Child</b> Maximum ratings permitted are: U.S.: TV-Y, TV-G, G Canada: C, G, TV-Y</p> <p><b>Youth</b> Maximum ratings permitted are: U.S.: TV-PG, PG Canada: C8+, PG, 8 ans+, TV-PG</p> <p><b>Young Adult</b> Maximum ratings permitted are: U.S.: TV-14, PG-13 Canada: 14+, 13 ans+, TV-14</p> <p><b>Custom</b> Select to set ratings manually. U.S.: See page 58 for details. Canada: See page 59 for details.</p>
<b>Downloadable U.S. Rating</b> (Available only in U.S.A. where advanced ratings exist)	<p><b>Off</b> Turn <b>Downloadable U.S. Rating</b> off. No programs that contain downloadable ratings are blocked from viewing.</p> <p><b>Custom</b> Select to block programs based on downloadable ratings.</p> <p><b>Clear All</b> Select to clear the entire downloadable rating system.</p>
<b>Unrated</b> (Available only when Country is set to U.S.A.)	<p><b>Allow</b> Allows programs and movies that are broadcasted without a rating.</p> <p><b>Block</b> Blocks all programs and movies that are broadcasted without a rating.</p>
<b>Channel Block</b>	Allows you to block channels regardless of program ratings.
	<b>To View a Blocked Channel</b>
	Press  when tuned to the blocked channel then enter the password.
<b>External Input Block</b>	Allows you to block external inputs regardless of program ratings.
	<b>To View a Blocked External Input</b>
	Press  when tuned to the blocked input then enter the password.



- You need your password for any future access into the **Parental Lock** settings. If you lose your password, see “Lost password” on page 78.
- Selecting **Clear All** will delete the current **Downloadable U.S. Rating** menu and the menu will no longer be available until the TV is tuned to a channel that contains downloadable ratings.
- If you block unrated TV programs, be aware that the following types of programs may be blocked: programs broadcasted from another country, emergency broadcasts, political programs, sports, news, public service announcements, religious programs and weather.

## US Models: Selecting Custom Parental Lock Rating Options

To select custom rating options for the U.S., select **U.S.A.** in the **Country** setting (page 57).

Option	Description
<b>Movie Rating</b>	<b>G</b> All children and general audience.
	<b>PG</b> Parental guidance suggested.
	<b>PG-13</b> Parental guidance for children under 13.
	<b>R</b> Restricted viewing, parental guidance is suggested for children under 17.
	<b>NC-17 and X</b> No one 17 or under allowed.
<b>TV Rating</b> Block programs by their rating, content or both	Age-Based Ratings
	<b>TV-Y</b> All children.
	<b>TV-Y7</b> Directed to children age 7 and older.
	<b>TV-G</b> General audience.
	<b>TV-PG</b> Parental guidance suggested.
	<b>TV-14</b> Parents strongly cautioned.
	<b>TV-MA</b> Mature audience only.
	Content-Based Ratings
	<b>FV</b> Fantasy violence.
	<b>D</b> Suggestive dialogue.
	<b>L</b> Strong language.
	<b>S</b> Sexual situations.
	<b>V</b> Violence.



- To ensure maximum blocking capability, set the Age-Based Ratings.

## Canadian Models: Selecting Custom Parental Lock Rating Options

To select custom rating options for Canada, select **Canada** in the **Country** setting (page 57).

Option	Description
<b>English Rating</b>	<b>C</b> All children.
	<b>C8+</b> Children 8 years and older.
	<b>G</b> General programming.
	<b>PG</b> Parental guidance.
	<b>14+</b> Viewers 14 and older.
	<b>18+</b> Adult programming.
<b>French Rating</b>	<b>G</b> General programming.
	<b>8 ans+</b> Not recommended for young children.
	<b>13 ans+</b> Not recommended for ages under 13.
	<b>16 ans+</b> Not recommended for ages under 16.
	<b>18 ans+</b> Programming restricted to adults.
<b>U.S.A. Rating</b>	See "US Models" on page 58 for details.

## Viewing Blocked Programs

You can view blocked programs by entering your password. Press  when tuned to a blocked program, then enter the password. This temporarily deactivates the parental control feature. To reactivate the **Parental Lock** settings, turn off the TV. When the TV is turned on again, your **Parental Lock** settings are reactivated.



## Using the Setup Settings

Option	Description
<b>Network</b>	<b>Network Setup</b> Sets the network status settings.
	<b>Refresh Internet Content</b> Reconnects to the Internet to receive available Internet content services.
<b>Home Network Setup</b>	<b>Show/Hide Media Servers</b> Displays the connected server list. You can select the server to display in the Home menu.
	<b>Media Server Troubleshooting</b> Diagnoses whether the TV can connect to each server on the home network.
	<b>Renderer Renderer</b> Enables the TV to play photo/music/video files on a device (e.g. digital still camera) by operating the device via the network.
	<b>Renderer Access Control</b> Allows access from a specified control device.
	<b>Renderer Options</b> Adjusts the <b>Renderer Options</b> detailed settings.

Option	Description
<b>Photo Frame Settings</b>	<b>Display Mode</b> Allows you to select the display mode. Select from <b>Image and Clock</b> , <b>Full Screen Image</b> and <b>Full Screen Clock</b> . See page 39.
	<b>Clock Display</b> Allows you to select the clock display. Select from <b>Calendar</b> , <b>Analog Clock</b> , <b>Digital Clock</b> , <b>Calendar and Clock</b> and <b>Clock</b> . When the <b>Display Mode</b> setting is set to <b>Image and Clock</b> , you can set to <b>Calendar</b> , <b>Analog Clock</b> or <b>Digital Clock</b> . When the <b>Display Mode</b> setting is set to <b>Full Screen Clock</b> , you can set to <b>Calendar</b> , <b>Calendar and Clock</b> or <b>Clock</b> . <b>Calendar and Clock</b> can be displayed only when <b>Display Mode</b> is <b>Full Screen Clock</b> .
	<b>Audio</b> <b>Music</b> You can enjoy music with this function.
	<b>Application</b> <b>Off</b> Turns off the music.
	<b>Image Selection</b> Select image.
	<b>Music Selection</b> Select music.
	<b>Slideshow Setting</b> <b>Slideshow</b> You can play a slideshow of photos.
	<b>Single View</b> Displays one photo only.
	<b>Music Playback Setting</b> <b>All Tracks</b> Listen to all music tracks.
	<b>Single Track</b> Set to listen to a single music track.
<b>Duration</b> Selects the time period ( <b>1h</b> , <b>2h</b> , <b>4h</b> or <b>24h</b> ) after which the TV automatically switches to standby mode.	
<b>First day of the week</b> Set <b>Sunday</b> or <b>Monday</b> as the first day of the week on the calendar.	
<b>USB Auto Start</b> Select <b>On</b> to start photo playback automatically when the TV is turned on and a digital still camera or other device containing photo files is connected to the USB port then turned on.	

Option	Description
<b>Closed Captions (CC)</b>	<b>CC Display</b>
	<b>On</b> <b>Closed Captions (CC)</b> is turned on.
	<b>Off</b> <b>Closed Captions (CC)</b> is turned off.
	<b>On when Muting</b> <b>Closed Captions (CC)</b> is turned on when the TV is muted.
<b>Analog CC</b>	Allows you to select basic analog (EIA-608) closed caption options.
	<b>CC1, CC2, CC3, CC4</b> Displays a printed version of the dialogue or sound effects of a program. (Should be set to <b>CC1</b> for most programs.)
	<b>Text1, Text2, Text3, Text4</b> Displays network/station information presented using either half or the whole screen (if available).
<b>Digital CC</b>	When the digital closed caption service is available, select from the <b>Service 1-6</b> or <b>CC1-4</b> .
<b>Digital CC Options</b>	Allows you to make additional settings for digital closed caption options. Select <b>As Broadcast</b> or <b>Custom</b> . The <b>Custom</b> option is available on the <b>Digital CC</b> setting.
	<b>Custom</b> Allows you to customize the following settings:
	<b>Character Size</b> Small, Standard, Large
	<b>Character Style</b> Style 1-7
	<b>Character Color</b> Color 1-8
	<b>Character Opacity</b> Solid, Translucent
	<b>Edge Type</b> None, Raised, Depressed, Outline, Left Shadow, Right Shadow
	<b>Edge Color</b> Color 1-8
	<b>Background Color</b> Color 1-8
	<b>Background Opacity</b> Solid, Translucent



- You can turn on **Closed Captions (CC)** options (**On**, **Off** or **On when Muting**) by pressing the **CC** button on the remote control.

Option	Description
<b>Info Banner</b>	Select <b>Small</b> to display minimal channel and program title or select <b>Large</b> to display detailed channel and program information along with the TV icon if you are viewing the TV. This information will appear if it is available from the broadcaster. <b>Info Banner</b> appears on the screen each time the channel and external inputs are changed or when <b>DISPLAY</b> on the remote control is pressed.
<b>Clock/Timers</b>	<p><b>Sleep Timer</b> Set the time in minutes (<b>Off, 15, 30, 45, 60, 90, or 120</b>) that you would like the TV to remain on before shutting off automatically.</p> <p><b>On Timer</b> Turns on the TV from standby mode at a time you set, and tuned to a channel or input of your preference. Before setting this function, make sure you set the correct current Time.</p> <p><b>Current Time</b> Set the current time manually. This can be set from <b>Initial Setup</b> or <b>Clock/Timers</b>. Adjust the <b>Current Time</b> for Daylight Saving Time.</p>
	 <ul style="list-style-type: none"> <li>This TV does not have a battery powered backup for the clock. Therefore, if there is a power failure or if you disconnect the power cord, be sure to reset the current date and time.</li> </ul>
<b>Initial Setup</b>	If you miss the <b>Initial Setup</b> when you first connected the TV or if you want to scan all receivable channels, select <b>Initial Setup</b> . Follow the instructions on the screen. Some settings such as <b>Picture, Sound, and Parental Lock</b> will not be affected by this <b>Initial Setup</b> . If you wish to return your TV to factory settings, please see the Troubleshooting section on page 78.
<b>Language</b>	Select to display all on-screen settings in your language of choice: <b>English, Español, Français</b> .
<b>Startup Logo</b>	Select <b>On</b> to display the logo when the TV is turned on. Select <b>Off</b> to disable it.
<b>AV Setup</b>	<p><b>Manage Inputs</b> Assigns name to external equipment. Select <b>Auto</b> to display names only when the equipment is connected, or always to display regardless of connection status.</p> <p><b>Video1/Component Selection</b> Select <b>Auto</b> to have the TV detect and switch between the <b>Video 1</b> or <b>Component</b> when <b>Video 1</b> or <b>Component</b> is connected.</p>



- Favorite channel list will be cleared each time you run the **Initial Setup**.
- You can assign following labels for each input:  
–, **Cable, Satellite, VCR, DVD/BD, Home Theater, Game, Camcorder, Digital Camera, PC, Edit** (except PC IN)  
–, **Edit** (for PC IN)
- “–” indicates that no labels are assigned.
- If you select **Edit**, you can edit video labels. Follow the same steps for **Edit Channel Labels** on page 56.

Option	Description
<b>HDMI Settings</b>	Communicates with equipment compatible with the <b>Control for HDMI</b> function.
	<b>Control for HDMI</b> Links the operations of the TV and the equipment. For specific Sony equipment compatible with <b>Control for HDMI</b> , this setting is applied automatically to the connected equipment when set to <b>On</b> .
	<b>Device Auto Power Off</b> Select <b>On</b> to have your connected equipment with <b>Control for HDMI</b> function power off automatically when the TV is turned off. Select <b>Off</b> to disable this function. This feature is available when <b>Control for HDMI</b> is <b>On</b> .
	<b>TV Auto Power On</b> Select <b>On</b> to control your TV's power on from your connected equipment with <b>Control for HDMI</b> function. Select <b>Off</b> to disable this function. This feature is available when <b>Control for HDMI</b> is <b>On</b> .
	<b>Device List</b> Displays a list of equipment with <b>Control for HDMI</b> function connected to the TV.
	<b>Device Control Keys</b> Select button functions of the TV's remote control to operate the connected equipment.
	<b>None</b> Deactivates the control by the TV's remote control.
	<b>Normal</b> Enables basic operations, such as navigation buttons (up, down, left or right, etc.).
	<b>Tuning Keys</b> For basic operations and operation of channel-related buttons, such as <b>CH +/-</b> or <b>0-9</b> , etc. Useful when you control a tuner or set-top box, etc; via the remote control.
	<b>Menu Keys</b> For basic operations and operation of the <b>HOME/OPTIONS</b> buttons. Useful when you select menus of a BD player, etc; via the remote control.
	<b>Tuning and Menu Keys</b> For basic operations and operation of channel-related buttons and <b>HOME/OPTIONS</b> buttons.
	<ul style="list-style-type: none"> <li>• Press <b>OPTIONS</b> while the equipment supporting <b>Control for HDMI</b> is connected to display the <b>Device Control</b> options. The <b>Device Control</b> option provides access to the <b>Home (Menu)</b>, <b>Options</b> and <b>Content List</b> of your connected equipment with your TV remote control.</li> <li>• Some equipment with <b>Control for HDMI</b> does not support the <b>Device Control</b> feature.</li> <li>• <b>HDMI Settings</b> must be setup on the connected equipment.</li> </ul>
<b>Picture Adjustments Lock</b>	Select <b>Lock</b> so no adjustment can be made to items grayed out.
	Select <b>Unlock</b> to allow adjustment to any of the <b>Picture</b> settings.
<b>Software Update</b>	Updates the TV system using USB memory or through Network. Select <b>USB</b> or <b>Network</b> to update.



Option	Description
<b>Automatic Software Download</b>	Select <b>On</b> to download the software automatically. Select <b>Off</b> to disable it.
<b>Product Support</b>	<p data-bbox="254 222 1135 342"><b>Contact Sony</b> Sony contact information is available on this screen for your convenience. TV specific information such as Model Name, Serial Number, Software Version and downloadable ratings (if available from the TV) are displayed here.</p>
	<p data-bbox="254 347 1135 407"><b>Signal Diagnostics</b> Press to display the diagnostics information for the current signal.</p>

## Using the Eco Settings

Option	Description
<b>Reset</b>	Resets the current <b>Eco</b> settings to the default values.
<b>Power Saving</b>	Select from <b>Off</b> , <b>Low</b> , <b>High</b> , <b>Picture Off</b> to adjust your TV's power consumption. By selecting the <b>High</b> option, you will reduce the power consumption more than the other available settings. While <b>Picture Off</b> is set, pressing <b>VOL +/-</b> or <b>MUTING</b> buttons will not disable this function. Press other buttons to disable it.
<b>Idle TV Standby</b>	Select to automatically power off the TV after <b>1h</b> , <b>2h</b> , or <b>4h</b> when no buttons are pressed on the remote control or the TV. Select <b>Off</b> to disable this function. This setting is not available if <b>Internet Contents</b> , <b>Applications</b> or <b>Internet Browser</b> are running.
<b>Light Sensor</b>	Optimizes the picture settings according to the ambient lighting.
<b>Auto Shut Off</b>	Select <b>On</b> to automatically power off the TV when no input signal is detected for a certain period of time. Select <b>Off</b> to disable this function.

# PC Input Signal Reference Chart for PC and HDMI IN

After connecting the PC to the TV, set the output signal from the PC according to the chart below.

Resolution			Horizontal frequency (kHz)	Vertical frequency (Hz)	Standard
Signals	Horizontal (Pixel)	× Vertical (Line)			
VGA	640	× 480	31.5	60	VGA
SVGA	800	× 600	37.9	60	VESA Guidelines
XGA	1,024	× 768	48.4	60	VESA Guidelines
WXGA	1,280	× 768	47.4	60	VESA
	1,280	× 768	47.8	60	VESA
	1,360	× 768	47.7	60	VESA
SXGA	1,280	× 1,024	64.0	60	VESA
HDTV*	1,920	× 1,080	67.5	60	CEA-861*

\* The 1080p timing when applied to the HDMI input will be treated as a video timing and not PC timing. This affects **Picture** settings and **Wide Mode** settings. To view PC content set **Scene Select** to **Graphics**, **Wide Mode** to **Full**, and **Display Area** to **Full Pixel**.



- This TV's PC input does not support Sync on Green or Composite Sync.
- This TV's PC VGA input does not support interlaced signals.
- Your PC must support one of the above PC input signals to display on the television.
- In plug and play, signals with a 60 Hz vertical frequency will be detected automatically. (PC reboot may be necessary.)

# Using a Wall-Mount Bracket

Your TV can be mounted on a wall using a Wall-Mount Bracket (not supplied) out of the box as packaged. Some larger size TV may require removing the Table-Top Stand; refer to the instructions provided with the TV.

Prepare the TV for the Wall-Mount Bracket before making cable connections.

**For product protection and safety reasons, Sony strongly recommends that you use the Wall-Mount Bracket designed for your TV and the installation should be performed by a Sony dealer or licensed contractor.**

- Follow the instruction guide provided with the Wall-Mount Bracket for your model. Sufficient expertise is required in installing this TV, especially to determine the strength of the wall for withstanding the TV's weight.
- Be sure to use the screws supplied with the Wall-Mount Bracket when attaching the mounting hooks to the TV set. The supplied screws are designed so that they are 8 mm to 12 mm in length when measured from the attaching surface of the mounting hook. The diameter and length of the screws differ depending on the Wall-Mount Bracket model. Use of screws other than those supplied may result in internal damage to the TV set or cause it to fall, etc.

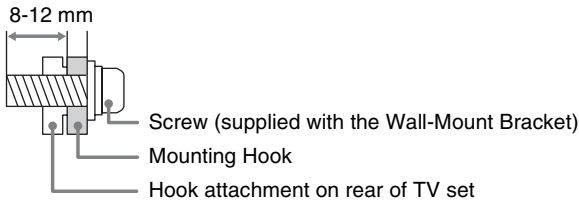

- Be sure to store the unused screws and Table-Top Stand in a safe place until you are ready to attach the Table-Top Stand. Keep the screws away from small children.



- Read the supplied Safety Booklet for additional safety information.

# Installing the Wall-Mount Bracket

---

## ■ To Customers

Your TV can be wall-mounted using SU-WL500 Wall-Mount Bracket (sold separately).

Please provide this installation information as well as the instruction supplied with SU-WL500 Wall-Mount Bracket to your installer.

## ■ To Sony Dealers and Licensed Contractors

To avoid injury and property damage, read these instructions carefully. Periodic inspection and maintenance is highly recommended to ensure that TV is securely mounted.

## ■ Note when installing

When using the SU-WL500 Wall-Mount Bracket, the space between the wall and the TV will be  $2\frac{3}{8}$  inches (6 cm). Use this space to route cables to the TV.

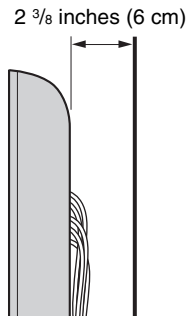

## For SU-WL500

### Step 1: Check the parts required for the installation

Open the Wall-Mount Bracket package and check the contents for all required parts along with the Instructions.

### Step 2: Decide on the installation location

Decide where you want to install your TV. Refer to the TV installation dimensions table. Refer to the Instructions for SU-WL500.

### ■ Dimension Table

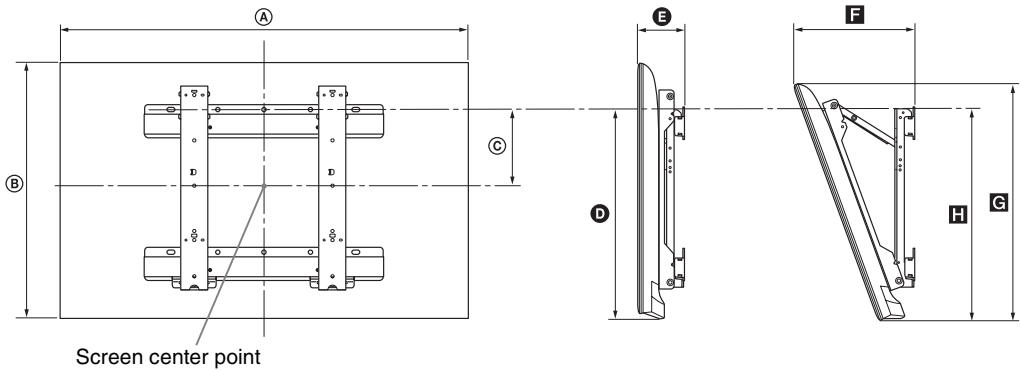

Unit: mm (inches)	TV Dimensions		Screen center dimensions	Length for each mounting angle					Weight	
	A	B		Angle (0°)		Angle (20°)			TV	x4
<b>TV Model</b>	<b>A</b>	<b>B</b>	<b>C</b>	<b>D</b>	<b>E</b>	<b>F</b>	<b>G</b>	<b>H</b>	<b>TV</b>	<b>x4</b>
KDL-55EX640	1,269 (50)	760 (30)	78 (3 1/8)	468 (18 1/2)	108 (4 3/8)	332 (13 1/8)	703 (27 3/4)	476 (18 3/4)	18.7 kg (41.2 lb.)	74.8 kg (164.8 lb.)
KDL-46EX640	1,074 (42 3/8)	649 (25 5/8)	133 (5 1/4)	468 (18 1/2)	108 (4 3/8)	294 (11 5/8)	599 (23 5/8)	476 (18 3/4)	14 kg (30.9 lb.)	56 kg (123.4 lb.)
KDL-40EX640	941 (37 1/8)	575 (22 3/4)	170 (6 3/4)	468 (18 1/2)	107 (4 1/4)	268 (10 5/8)	529 (20 7/8)	475 (18 3/4)	11.5 kg (25.4 lb.)	46 kg (101.4 lb.)

Figures in the above table may differ slightly depending on the installation.

### CAUTION

The wall that the TV will be installed on should be capable of supporting a weight of at least four times that of the TV. Refer to your TV's operating instructions for its weight.

### Step 3: Install the Base Bracket on the wall

Refer to the Instructions for SU-WL500.

### Step 4: Prepare the TV for wall mount installation

Follow the steps below to prepare for installing the TV.

- 1 Disconnect all the cables from the TV.
- 2 Detach the Table-Top Stand from the TV.

Remove the screws guided by the arrow marks and of the TV.  
Do not remove any other screws from the TV.

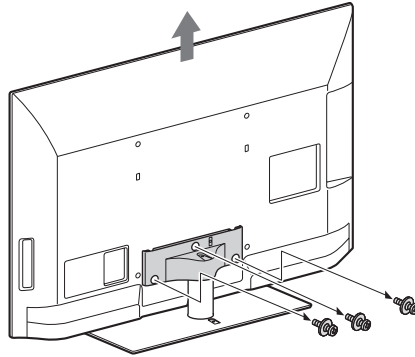

- 3 Place the TV with its screen facing down on a level and stable surface covered with a thick and soft cloth.
- Before attaching the Wall-Mount Bracket, hang the AC power cord down behind the TV.

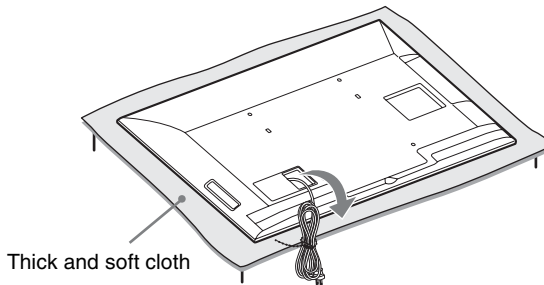

#### 4 Secure the Mounting Hook to the rear of the TV.

Determine the screw locations and secure the Mounting Hooks to the rear of the TV. Refer to the “Screw and Hook Locations Diagram/Table” shown below.

- 1 Secure the Mounting Hooks to the rear of the TV using only the supplied screws (M6 × 16).
- 2 Be sure to tighten the screws with equal torque strength.

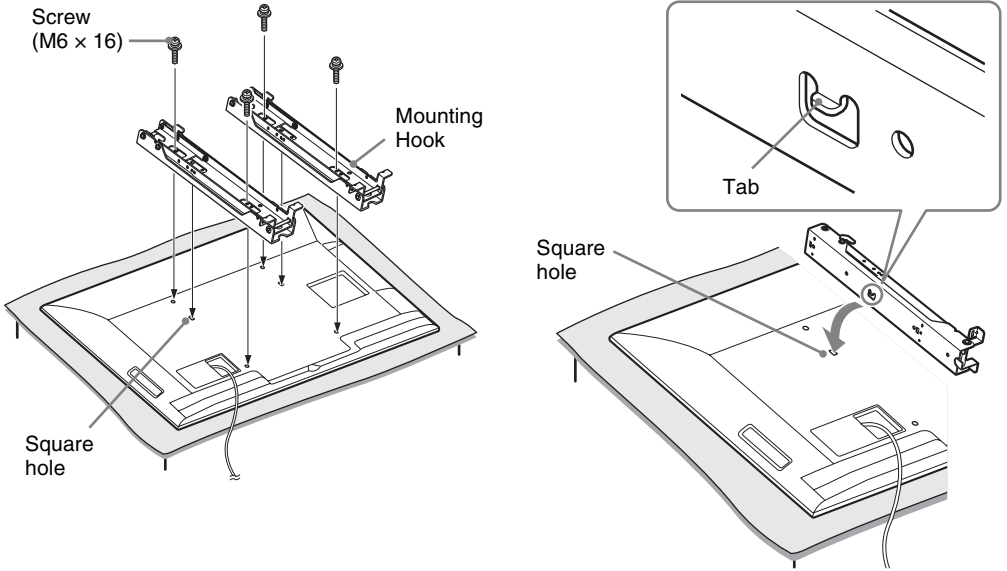

#### ■ Screw and Hook Locations Diagram/Table

TV Model	Screw location	Hook location
KDL-55EX640/KDL-46EX640/KDL-40EX640	e, j	b



## Screw location

When installing the Mounting Hooks on the TV.

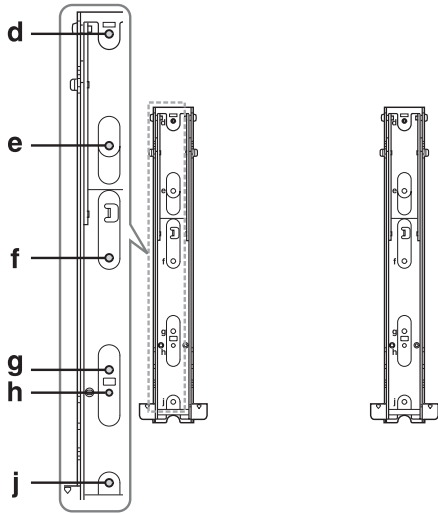

## Hook location

When installing the TV onto Base Bracket.

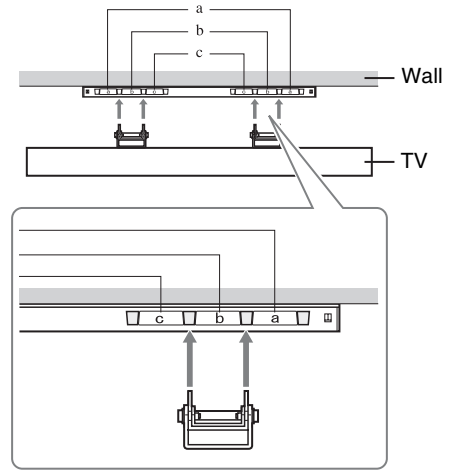

**5** Adjust the angle of the Mounting Hook.

Refer to the Instructions for SU-WL500.

## Step 5: Install the TV on the wall

Refer to the Instructions for SU-WL500.



- When you put the TV back on the Table-Top Stand, reverse the above steps.
- When moving the TV, do not squeeze the bottom of the front panel too tight.
- Remove the screws or install the Mounting Hook on a stable and level surface.

# Troubleshooting

Many of the poor pictures and poor sound conditions are related to improper connection of the cables; refer to the Quick Setup Guide provided for connections.

If you have questions, service needs, or require technical assistance related to the use of your Sony TV even after you read this operating instructions manual, contact the following:

## For US Support:

<http://www.sony.com/tvsupport> or call 1-800-222-SONY (7669)

## For Canadian Support:

<http://www.sony.ca/support> or call 1-877-899-SONY (7669)

### ■ Things to consider

- Check the input selection by pressing the **INPUT** button. You may be watching the wrong input.
- If you cannot hear sound from the TV, you may have accidentally pressed the **MUTING** button on your remote control; press the **MUTING** button again or press **VOL +** to deactivate muting.
- If the remote control is not functioning properly, the batteries may be installed incorrectly or may be low or an object or light may be interfering with the remote control.
- To reset the TV to factory default settings:
  - 1 Turn on the TV.
  - 2 Press and hold down the **▲** button on the remote, press the **⏻** button on the TV set. (The TV will turn itself off, then back on again.)
  - 3 Release the **▲** button when the TV is turn on.

**IMPORTANT:** The factory reset will clear all of your customized settings including the **Parental Lock** setting.

When the Password is lost or cannot be remembered, enter the master password: 4357. This password clears your previous password and allows you to enter a new password.

Condition	Explanation/Solution
No picture	<ul style="list-style-type: none"><li>• Check the <b>Power Saving</b> settings (see page 66).</li></ul>
Cannot receive any channels	<ul style="list-style-type: none"><li>• Make sure the power cord is connected securely.</li><li>• Turn on the power of the TV.</li><li>• Check cable/antenna connections.</li><li>• Make sure the <b>Signal Type</b> setting is correct for your TV signal source.</li></ul>

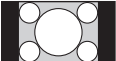

Condition	Explanation/Solution
TV is locked to one channel	<ul style="list-style-type: none"> <li>Perform <b>Auto Program</b> to add receivable channels that are not present in the TV's memory (see pages 22 and 56).</li> </ul>
Cannot receive or select channels	<ul style="list-style-type: none"> <li>Perform <b>Auto Program</b> to add receivable channels that are not present in the TV's memory (see pages 22 and 56).</li> <li>To receive or select cable channels, make sure that <b>Signal Type</b> in the <b>Channel</b> settings is set to <b>Cable</b> (see page 56). To receive or select UHF channels over an antenna, make sure <b>Signal Type</b> is set to <b>Antenna</b>.</li> </ul>
The TV turns off automatically	<ul style="list-style-type: none"> <li>Check if <b>Sleep Timer</b> is activated (see page 63).</li> <li>Check <b>Idle TV Standby</b> in the <b>Eco</b> settings.</li> </ul>
No picture from some video sources	<ul style="list-style-type: none"> <li>Check the connection between the optional video equipment and the TV.</li> <li>Press <b>INPUT</b> on the remote control (see page 35).</li> </ul>
<b>Poor picture</b>	
Picture quality not as good as viewed at the store	<ul style="list-style-type: none"> <li>Picture quality depends on the signal content. See Quick Setup Guide (supplied) to display the best possible picture for that signal.</li> </ul>
Broadcast HD formats have poor quality	<ul style="list-style-type: none"> <li>Content and signal quality are controlled by the signal provider. Many HD channels and content are actually upscaled versions of standard-definition broadcasts. The picture is affected by the quality of the signal received, which varies between channel and program.</li> </ul>
Double images or ghosts	<ul style="list-style-type: none"> <li>Check cable/antenna connections.</li> <li>Check the antenna location and direction.</li> </ul>
Only snow and noise appear on the screen	<ul style="list-style-type: none"> <li>Check if the antenna is broken or bent.</li> <li>Check if the antenna has reached the end of its serviceable life. (3-5 years in normal use, 1-2 years at the seaside.)</li> </ul>
Dotted lines or stripes	<ul style="list-style-type: none"> <li>Keep the TV away from noise sources such as cars, motorcycles, or hair-dryers.</li> <li>If using 300 ohm twin lead, move the excess lead away from the TV or try using 75-ohm coaxial cable instead.</li> </ul>
No color / Dark picture / Color is not correct / The picture is too bright	<ul style="list-style-type: none"> <li>Adjust the <b>Picture Mode</b> options in the <b>Picture</b> settings (see page 50).</li> <li>If you set the <b>Power Saving</b> mode to <b>Low</b> or <b>High</b>, it will enhance the black level.</li> </ul>
Noisy picture	<ul style="list-style-type: none"> <li>Make sure that the antenna is connected using a 75-ohm coaxial cable (not supplied).</li> <li>Keep the antenna cable away from other connecting cords.</li> <li>To avoid TV interference, make sure to use an undamaged antenna cable.</li> </ul>
Blurry picture / Poor color	<ul style="list-style-type: none"> <li>Transporting the TV from a cold to a warm location or a sudden change in room temperature may cause moisture condensation, resulting in a blurry picture or poor color. Turn off your TV and wait a few hours before powering on again.</li> </ul>

Condition	Explanation/Solution
<b>No sound / Noisy sound</b>	
No sound but good picture	<ul style="list-style-type: none"> <li>• Check the volume control.</li> <li>• Press <b>MUTING</b> or <b>VOL +</b> so that “Muting” disappears from the screen (see page 26).</li> <li>• Set <b>Speakers</b> to <b>TV Speakers</b> in the <b>Sound</b> settings (see page 53). If it is set to <b>Audio System</b>, sound is not output from the TV’s speakers regardless of the TV’s volume control.</li> <li>• When using HDMI input with Super Audio CD or DVD-Audio, DIGITAL AUDIO OUT (OPTICAL) may not provide an audio signal.</li> <li>• When tuned to a digital channel with <b>Alternate Audio</b>, the broadcaster may not be broadcasting your preferred <b>Alternate Audio</b> language. Press <b>OPTIONS</b>, highlight and select <b>Alternate Audio</b>, and change the <b>Alternate Audio</b> language (see page 53).</li> </ul>
Audio noise	<ul style="list-style-type: none"> <li>• Make sure that the antenna is connected using a 75-ohm coaxial cable (not supplied).</li> <li>• Keep the antenna cable away from other connecting cords.</li> <li>• To avoid TV interference, make sure to use an undamaged antenna cable.</li> </ul>
No audio or low audio with Home Theater System	<ul style="list-style-type: none"> <li>• Set <b>Speakers</b> to <b>Audio System</b> in the <b>Sound</b> settings (see page 53).</li> <li>• Set <b>Audio Out</b> to Fixed in the Sound settings (see page 53).</li> </ul>
No color / Irregular picture	<ul style="list-style-type: none"> <li>• Verify that the <b>Video1/Component Selection</b> (see page 63) is set to the current input type in use. We suggest leaving this setting to <b>Auto</b>.</li> </ul>
<b>BRAVIA Sync</b>	
Cannot find connected <b>BRAVIA</b> Sync HDMI device	<ul style="list-style-type: none"> <li>• Make sure that the <b>Control for HDMI</b> is set up on both the TV and the optional device compatible with <b>BRAVIA</b> Sync (see page 30).</li> </ul>
Second A/V receiver is not listed on the <b>Device List</b>	<ul style="list-style-type: none"> <li>• Only one A/V receiver may be used with the <b>BRAVIA</b> Sync and <b>Control for HDMI</b> functions at one time (see page 64).</li> </ul>
<b>PC Input</b>	
No picture / No signal	<ul style="list-style-type: none"> <li>• Confirm the PC is correctly connected to the TV with either the PC IN (with an HD15 cable) or with the HDMI IN.</li> <li>• Ensure the output signal from the PC is one of the formats listed on page 67.</li> <li>• Turn the PC off. Confirm the PC connection and restart the PC. Plug-and-play will auto-detect the TV and correctly set up PC timing.</li> <li>• Verify the PC is not in standby or hibernation mode.</li> </ul>
Poor Picture	<ul style="list-style-type: none"> <li>• Adjust the resolution (see page 67).</li> <li>• Adjust <b>Pitch</b> and <b>Phase</b> (see page 55).</li> </ul>

Condition	Explanation/Solution
<b>General</b>	
TV screen feels warm	<ul style="list-style-type: none"> <li>• Due to the thin profile of this television, the heat generated by the LCD panel backlight and supporting electronics will be more noticeable. This is normal operation and not a cause for concern.</li> </ul>
<b>Wide Mode</b> changes automatically	<ul style="list-style-type: none"> <li>• The current <b>Wide Mode</b> setting is automatically replaced with the <b>4:3 Default</b> setting when you change the channel or video input, if <b>4:3 Default</b> in the <b>Screen</b> settings is set to other than <b>Off</b>. If you want to lock in <b>Wide Mode</b> selected with <b>WIDE</b> on the remote control, set <b>4:3 Default</b> to <b>Off</b> in the <b>Screen</b> settings (see page 54).</li> <li>• Check the <b>Auto Wide</b> option in the <b>Screen</b> settings (see page 54).</li> </ul>
Suddenly the picture gets smaller 	<ul style="list-style-type: none"> <li>• The picture gets smaller during the commercials due to the method in which the provider broadcasts their content. When HD content channels switch to SD content (commercials), the picture may be small with a black border.</li> <li>• <b>Auto Wide</b> will not expand the picture during these content changes since the content information is regulated by the channel signal provider. You can manually change the <b>Wide Mode</b> if you prefer (see page 33). This setting will remain in effect until you change the channel or input or manually change the <b>Wide Mode</b> again.</li> </ul>
"Black box" on screen	<ul style="list-style-type: none"> <li>• You have selected a text option and no text is available (see page 62). To turn off this feature, set the <b>CC Display</b> option to <b>Off</b>. If you were trying to select closed captioning, select <b>CC1</b> instead of <b>Text1-4</b>.</li> </ul>
Black bands appear at the edges of the screen 	<ul style="list-style-type: none"> <li>• Some wide screen programs are filmed in aspect ratios that are greater than 16:9 (this is especially common with theatrical releases). Your TV will show these programs with black bands at the top and bottom of the screen. For more details, check the documentation that came with your DVD/Blu-ray (or contact your program provider).</li> <li>• Programs in 4:3 aspect ratio will have bands on left and right sides of the screen.</li> <li>• Programs broadcast in HD formats (720p and 1080i) with 4:3 content will commonly have black bands on the left and right sides of the screen which are added by the broadcaster (see image on left).</li> <li>• <b>Auto Wide</b> will not expand the picture when the black bands on the sides of the screen are added by the broadcaster. You can manually change the <b>Wide Mode</b> to <b>Wide Zoom</b>, or <b>Zoom</b> to fill the screen, which will remain in effect until you change the channel or input or manually change the <b>Wide Mode</b> again.</li> </ul>

Condition	Explanation/Solution
Certain programs on DVD or other digital sources display a loss of detail, especially during fast-motion or dark scenes	<ul style="list-style-type: none"> <li>• This is due to the digital compression of the source content used by certain digital broadcasts and DVDs which may cause your TV's screen to display less detail than usual, or cause artifacts (small blocks or dots, pixelations) to appear on your screen. These signal compressions are more visible and are dependent on the clarity and resolution of the TV.</li> </ul>
Remote control does not operate	<ul style="list-style-type: none"> <li>• To determine if the problem is with the remote control or not, press a button on the TV.</li> <li>• Check the polarity of the batteries or replace the batteries.</li> <li>• Point the remote control at the remote control sensor located at the front of the TV.</li> <li>• Keep the remote control sensor area clear from obstacles.</li> <li>• Fluorescent lamps can interfere with your remote control operation; try turning off the fluorescent lamps.</li> </ul>
Some digital cable channels are not being displayed	<ul style="list-style-type: none"> <li>• Certain cable companies have limitations on the broadcast of digital cable channels. Check with your cable company for more information.</li> <li>• The digital cable channel may be set to <b>Hidden</b> in the <b>Show/Hide Channels</b> setting (see page 56).</li> </ul>
Some photo, music, or video files are not displaying from my USB equipment	<ul style="list-style-type: none"> <li>• The accessible file or folder limit in a directory is 1,000 for USB connected equipment. This limit includes non-supported files or just folders. Files or folders are populated based on their time stamps. Photo, music files or folders exceeding the limit will not be displayed.</li> </ul>
Photo images appear small in the screen	<ul style="list-style-type: none"> <li>• Set display size to expanded.</li> <li>• Whether photo images can be displayed in full screen or not depends on the resolution or aspect ratio of the file.</li> </ul>
Photo images or folders take time to display	<ul style="list-style-type: none"> <li>• Depending on the image dimension, file size, and number of files in a folder, some photo images or folders take time to display.</li> <li>• The first time a camera is connected to the TV via USB cable, it may take up to a couple of minutes for the photos to display.</li> </ul>
Lost password	<ul style="list-style-type: none"> <li>• Select the <b>Password</b> settings on the <b>Parental Lock</b> settings, then enter the following master password: 4357. This password clears your previous password and allows you to enter a new password (see page 57).</li> </ul>
How to reset the TV to factory settings	<ul style="list-style-type: none"> <li>• Turn on the TV. While holding down <b>▲</b> on the remote control, press <b>⏻</b> on the TV. (The TV will turn itself off, then back on again.) Release <b>▲</b>.  <b>IMPORTANT:</b> The reset will clear all of your customized settings including the <b>Parental Lock</b> setting.</li> </ul>

Condition	Explanation/Solution
Sometimes video streaming quality is poor when using the wireless LAN	<ul style="list-style-type: none"> <li>The wireless network connection quality varies depending on the distance or obstacles (e.g. wall) between the TV/USB Wireless LAN Adapter and the wireless router (access point), environment interference, and quality of the wireless router (access point). If using USB Wireless LAN Adapter, it is suggested to use a wireless router (access point) supporting 5GHz operation for video streaming and place it closer to the USB Wireless LAN Adapter (not applicable for models with built-in wireless LAN device).</li> </ul>
Wireless LAN connection fails or radio reception conditions are poor	<ul style="list-style-type: none"> <li>Check the installation location of the TV and wireless router (access point). Signal condition may be affected for the following reasons. <ul style="list-style-type: none"> <li>Other wireless devices, microwaves, fluorescent lights, etc., are placed nearby.</li> <li>There are floors or walls between the wireless router (access point) and TV. If the problem persists even after checking the above, try making a wired LAN connection.</li> </ul> </li> <li>When using a USB Wireless LAN Adapter, move it to avoid signal interference by using an extension cable with base unit (optional accessory).</li> </ul>
Poor picture on Internet Video	<ul style="list-style-type: none"> <li>Quality depends on the original video provided by the video content provider and your connection bandwidth.</li> </ul>
Small picture on Internet Video	<ul style="list-style-type: none"> <li>Use the color buttons to zoom in and out.</li> </ul>
Certain Internet video content displays a loss of detail, especially during fast-motion or dark scenes	<ul style="list-style-type: none"> <li>Video quality and picture size depend on broadband speed and delivery by content providers.</li> </ul>
Good picture quality but no sound on the Internet video content	<ul style="list-style-type: none"> <li>Quality depends on the original content provided by the video content provider and your connection bandwidth.</li> <li>Due to the nature of Internet video, not all videos will contain sound.</li> </ul>
You do not see many videos in the Internet Video Guide	<ul style="list-style-type: none"> <li>Press <b>OPTIONS</b> and select categories to view more content.</li> <li>Check the <b>Parental Lock</b> ratings on the TV; some Internet content may be blocked based on the rating.</li> </ul>
Widgets are inaccessible	<ul style="list-style-type: none"> <li>Check that the LAN cable or AC power cord (mains lead) of the router/modem* has been connected properly. *Your router/modem must be set in advance to connect to the Internet. Contact your Internet service provider for router/modem settings.</li> <li>Try using Widgets later. The Widget content provider's server may be out of service.</li> </ul>

Condition	Explanation/Solution
You cannot add a new Widget	<ul style="list-style-type: none"> <li>Your TV comes with preinstalled apps which occupy a certain amount of the allotted app memory. To add a new app, you may have to delete an existing app. Press <b>Home</b>, then press <b>▲/▼</b> to select <b>Applications</b>, press <b>⊕</b>, then press <b>◀/▶</b> to select the Widget you want to delete. Press yellow button, then press <b>▲/▼</b> to select <b>Delete App</b>, and press <b>⊕</b>.</li> </ul>
Your TV cannot connect to the server	<ul style="list-style-type: none"> <li>Check the LAN cable or connection to your server and your TV.</li> <li>Check if your network is properly configured on your TV.</li> </ul>
A message appears starting that the TV cannot connect to your network	<ul style="list-style-type: none"> <li>Check the current network settings. Press <b>HOME</b>, then select <b>Settings &gt; Setup &gt; Network &gt; Network Setup &gt; View Network settings and status</b>. If all of your network settings are "-", your server may not be connected properly. Check your network connections and/or server's instruction manual for connection information.</li> <li>Reconfigure your network settings.</li> <li>If the LAN cable is connected to an active server and the TV has acquired an IP address, check your DLNA Certified™ media server's connections and configurations.</li> </ul>
DLNA Certified™ media server is inaccessible although it is listed under  [Media] in the Home Menu	<div data-bbox="392 662 434 703" style="text-align: center;"></div> <ul style="list-style-type: none"> <li>Your IP address configuration can be viewed by selecting the <b>View Network settings and status</b> option.</li> <li>Check your LAN cable/connection or your server connections. The TV may have lost connection with the server.</li> <li>Perform <b>Media Server Troubleshooting</b> to check if your media server is properly communicating with the TV. Press <b>HOME</b>, then select <b>Settings &gt; Setup &gt; Network &gt; Home Network Setup &gt; Media Server Troubleshooting</b>.</li> </ul>
Some photos, music, video files in the connected USB device or DLNA Certified™ media server are not displayed	<ul style="list-style-type: none"> <li>Unsupported files may not be displayed.</li> <li>The accessible file or folder limit in a directory is 1,000 for USB and a DLNA Certified™ media server. This limit includes non-supported files or just folders. Files or folders are populated based on their timestamps. Photo, music files or folders exceeding the limit will not be displayed.</li> </ul>
When using the renderer function, music files cannot be played back	<ul style="list-style-type: none"> <li>Some applications display a photo file pre-installed in the PC simultaneously with music playback when using the renderer function. Depending on the pre-installed photo file, music playback may not be possible, but may become possible by changing the photo file.</li> </ul>
The TV surrounds become warm.	<ul style="list-style-type: none"> <li>When the TV is used for an extended period, the TV surrounds become warm. You may feel hot when touching there by the hand.</li> </ul>



# Important Notices

## Declaration of Conformity

Trade Name: SONY  
Model: KDL-55EX640/KDL-46EX640/KDL-40EX640  
Responsible Party: Sony Electronics Inc.  
Address: 16530 Via Esprillo,  
San Diego, CA 92127 U.S.A.  
Telephone Number: 858-942-2230

This device complies with part 15 of the FCC rules. Operation is subject to the following two conditions: (1) This device may not cause harmful interference, and (2) this device must accept any interference received, including interference that may cause undesired operation.

## For Customers in Canada

This Class B digital apparatus complies with Canadian ICES-003.

## FCC Related Information

This equipment has been tested and found to comply with the limits for a Class B digital device, pursuant to Part 15 of the FCC Rules. These limits are designed to provide reasonable protection against harmful interference in a residential installation. This equipment generates, uses and can radiate radio frequency energy and, if not installed and used in accordance with the instructions, may cause harmful interference to radio communications. However, there is no guarantee that interference will not occur in a particular installation. If this equipment does cause harmful interference to radio or television reception, which can be determined by turning the equipment off and on, the user is encouraged to try to correct the interference by one or more of the following measures:

- Reorient or relocate the receiving antenna.
- Increase the separation between the equipment and receiver.
- Connect the equipment into an outlet on a circuit different from that to which the receiver is connected.
- Consult the dealer or an experienced radio/TV technician for help.

Pursuant to FCC regulations, you are cautioned that any changes or modifications not expressly approved in this manual could void your authority to operate this equipment.

## Compatible Wall-Mount Bracket Information

Use the following Sony Wall-Mount Bracket with your TV model.

	Sony TV Model No.
	KDL-55EX640/ KDL-46EX640/ KDL-40EX640
Sony Wall-Mount Bracket Model No.	SU-WL500

Use with other Wall-Mount Brackets may cause instability and could result in property damages or injury.

## Note

This television includes a QAM demodulator which should allow you to receive unscrambled digital cable television programming via subscription service to a cable service provider. Availability of digital cable television programming in your area depends on the type of programming and signal provided by your cable service provider.

## To Customers

Sufficient expertise is required for TV installations. Be sure to subcontract the installation to a Sony dealer or licensed contractor and pay adequate attention to safety during the installation.

## Pour les clients résidant au Canada

Cet appareil numérique de la classe B est conforme à la norme NMB-003 du Canada.

## Information sur le support de fixation murale compatible

Utilisez le support de fixation murale Sony cidessous correspondant au modèle de votre téléviseur.

	Numéro de modèle de téléviseur Sony
	KDL-55EX640/KDL-46EX640/ KDL-40EX640
Numéro de modèle du support de fixation murale Sony	SU-WL500

L'utilisation d'un autre support de fixation murale peut provoquer l'instabilité de l'appareil et causer des blessures ou des dommages matériels.

# Specifications

<b>System</b>	
Television system	NTSC: American TV standard ATSC (8VSB terrestrial): ATSC compliant 8VSB QAM on cable: ANSI/SCTE 07 2000 (Does not include CableCARD functionality)
Channel coverage	Analog terrestrial: 2 - 69 / Digital terrestrial: 2 - 69 Analog Cable: 1 - 135 / Digital Cable: 1 - 135
Panel system	LCD (Liquid Crystal Display) Panel LED backlight
Speaker output	10 W + 10 W (KDL-55EX640)   8 W + 8 W (KDL-46EX640, KDL-40EX640)
<b>Input/Output jacks</b>	
CABLE/ANTENNA	75-ohm external terminal for RF inputs
VIDEO IN 1/2	VIDEO: 1 Vp-p, 75 ohms unbalanced, sync negative AUDIO: 500 mVrms (Typical) / Impedance: 47 kilohms
COMPONENT IN	YPbPr (Component Video): Y: 1.0 Vp-p, 75 ohms unbalanced, sync negative / PB: 0.7 Vp-p, 75 ohms PR: 0.7 Vp-p, 75 ohms / Signal format: 480i, 480p, 720p, 1080i, 1080p AUDIO: 500 mVrms (Typical) / Impedance: 47 kilohms
HDMI IN 1/2/3/4	HDMI: Video: 480i, 480p, 720p, 1080i, 1080p, 1080/24p Audio: Two channel linear PCM 32, 44.1 and 48 kHz, 16, 20 and 24bits, Dolby Digital PC Input (see page 67)
AUDIO OUT	500 mVrms (typical)
DIGITAL AUDIO OUT (OPTICAL)	PCM/Dolby Digital optical signal
PC IN	D-sub 15-pin, analog RGB, 0.7 Vp-p, 75 ohms, positive See the PC Input Signal Reference Chart for PC and HDMI IN on page 67.
PC/HDMI IN 1 AUDIO IN	Stereo mini jack, 500 mVrms, (Typical) / Impedance: 47 kilohms
USB	Compliant with USB mass storage e.g. digital camera or USB memory. Also compliant with UWA-BR100 as WiFi Dongle.
DLNA	DLNA Certified™ codec is the same as USB. (Some DLNA Certified™ servers may not be able to play back.)
LAN	10BASE-T/100BASE-TX connector (Depending on the operating environment of the network, connection speed may differ. 10BASE-T/100BASE-TX communication rate and communication quality are not guaranteed for this TV.)

Model name KDL-	55EX640	46EX640	40EX640
<b>Power and others</b>			
Power requirement	110-240 V AC, 50/60 Hz (U.S.A./Canada 120 V AC, 60 Hz)		
Power consumption in use	150 W	115 W	97 W
in standby	Less than 0.25 W with 120 V AC and with 240 V AC less than 0.35 W		
Screen size* (inches measured diagonally)	54.6 (55 class)	46	40
Display resolution	1,920 dots (horizontal) × 1,080 lines (vertical)		
Speaker/Full range (2) (mm) (inches)	30 × 150 (1 <sup>3</sup> / <sub>16</sub> × 6)		
Dimensions* with stand (mm) (inches)	1,269 × 797 × 311 50 × 31 <sup>1</sup> / <sub>2</sub> × 12 <sup>1</sup> / <sub>4</sub>	1,074 × 686 × 251 42 <sup>3</sup> / <sub>8</sub> × 27 <sup>1</sup> / <sub>8</sub> × 10	941 × 612 × 231 37 <sup>1</sup> / <sub>8</sub> × 24 <sup>1</sup> / <sub>8</sub> × 9 <sup>1</sup> / <sub>8</sub>
without stand (mm) (inches)	1,269 × 760 × 60 50 × 30 × 2 <sup>3</sup> / <sub>8</sub>	1,074 × 649 × 60 42 <sup>3</sup> / <sub>8</sub> × 25 <sup>5</sup> / <sub>8</sub> × 2 <sup>3</sup> / <sub>8</sub>	941 × 575 × 60 37 <sup>1</sup> / <sub>8</sub> × 22 <sup>3</sup> / <sub>4</sub> × 2 <sup>3</sup> / <sub>8</sub>
wall-mount hole pattern (mm)	300 × 300		
wall-mount screw size (mm)	M6 (length: refer to diagram on page 68)		
Mass* with stand (kg) (lb.)	23.1 50.9	17.2 37.9	14.1 31.1
without stand (kg) (lb.)	18.7 41.2	14.0 30.9	11.5 25.4
Supplied accessories common to all models	Remote control RM-YD075 (1)/Size AAA batteries (2)/Operating Instructions (this manual) (1)/Quick Setup Guide (1)/Warranty Card (1)/Safety and Regulatory Booklet (1)/Software License (1)/Stand installation guide (1)/Table-Top Stand (1 set)/Operating Instructions of USB Wireless LAN Adapter (1)/USB Wireless LAN Adapter: UWA-BR100 (1)/Unique 1.5 m extension cable (1)		
individual models	Screw (7)		
Optional accessories	Connecting cables / Support Belt Kit / Wall-Mount Bracket: SU-WL500		

- Optional accessories availability depends on its stock.
- Design and specifications are subject to change without notice.
- \* Dimensions and mass are approximate values.

# Index

0-9 buttons 26  
4:3 Default 54

## A

Add Digital Channels 56  
Advanced Settings 51  
Alternate Audio 53  
Analog Fine Tune 56  
AUDIO OUT 12  
Audio Out 53  
Auto Display Area 54  
Auto Program 22, 56  
Auto Shut Off 66  
Auto Wide 54  
Automatic Software Download 65  
AV Setup 63

## B

Backlight 50  
Balance 52  
Bass Booster 52  
Brightness 50

## C

CABLE/ANTENNA 12  
CC button 27  
CH +/- button 27, 28  
Change Password 57  
Channel Block 57  
CineMotion 50  
Clock/Timers 63  
Closed Captions (CC) 62  
Color 50  
Color Temperature 50  
Colored buttons 25  
COMPONENT IN 12  
Country 57

## D

DIGITAL AUDIO OUT (OPTICAL)  
11  
Display Area 54  
DISPLAY button 27  
DLNA 6  
Downloadable U.S. Rating 57

## E

Edit Channel Labels 56  
English Rating 59  
Equalizer 52  
Equipment Control button 25  
External Input Block 57

## F

French Rating 59

## H

HDMI IN 11  
HDMI Settings 64  
HDMI/DVI Audio Source 53  
Home Network Setup 60  
HOME/MENU button 26, 28  
Horizontal Center 54, 55  
Hue 50

## I

Idle TV Standby 66  
Info Banner 63  
Infrared Receiver (IR) 28  
Initial Setup 63  
INPUT button 25, 28  
Installing the TV on a wall 68, 69

## J

JUMP button 27

## L

Language 63  
Light sensor 28, 66

## M

Manage Inputs 63  
Movie Rating 58  
MPEG Noise Reduction 50  
MTS Audio 53  
Music 35  
MUTING button 26

## N

Netflix 26, 46  
Network Setup 60  
Noise Reduction 50

## O

OPTIONS 27

## P

PAP 32  
Password 57  
PC IN 11  
PC Settings 55  
Photo 35  
Photo Frame 26, 39  
Photo Frame Settings 61  
Picture 50  
Picture Adjustments Lock 64  
Picture Mode 50  
Picture Off (⊗) LED 28  
PIP 31  
Power (⏻) button 28  
POWER (⏻) button 26  
POWER (⏻) LED 28  
Power Saving 66

Product Support 65

## R

Rating 57  
Reset 50, 52, 66, 78  
RETURN button 26

## S

SCENE button 26  
Settings  
Channel 56  
Eco 66  
Parental Lock 57  
Picture 50  
Screen 54  
Setup 60  
Sound 52  
Sharpness 50  
Show/Hide Channels 56  
Signal Type 56  
Sleep Timer 63  
Software Update 64  
Sony Entertainment Network 45  
Sound Mode 52  
Speakers 53  
Standby (⏻) LED 28  
Startup Logo 63  
Steady Sound 52  
Surround 52  
SYNC MENU button 27

## T

Timer (⏻) LED 28  
Troubleshooting 74–80  
TV Rating 58

## U

U.S.A. Rating 59  
Unrated 57  
USB 12  
USB Auto Start 61

## V

Vertical Center 54, 55  
Video 35  
VIDEO/AUDIO (L/R) 12  
Viewing Blocked Programs 59  
VOL (⏮) +/- button 26, 28  
Volume Offset 52

## W

WIDE button 25  
Wide Mode 54, 55

## Y

Yahoo! Widgets 46  
YouTube Leanback 46







## For Your Convenience

### Online Registration:

Be sure to register your TV.

**United States**     <http://productregistration.sony.com>

**Canada**             <http://www.sony.ca/registration>

### Software Updates:

Your TV is capable of receiving software updates. For the latest information about software updates for your TV, visit:

**United States**     <http://www.sony.com/tvsupport>

**Canada**             <http://www.sony.ca/support>

**NOTE:** If your TV is connected to the Internet, you can check for software updates by selecting **Settings, Product Support** and then **Automatic Software Update**.

