



Contact SAMSUNG WORLDWIDE

If you have any questions or comments relating to Samsung products, please contact the SAMSUNG customer care center.

Country	Customer Care Center ☎	Web Site	Address
CANADA	1-800-SAMSUNG (726-7864)	www.samsung.com	Samsung Electronics Canada Inc., Customer Service 55 Standish Court Mississauga, Ontario L5R 4B2 Canada
MEXICO	01-800-SAMSUNG (726-7864)	www.samsung.com	C.P 11570 AV. Presidente Masaryk No.111, Int. 701 Col. Chapultepec Morales, Delegacion Miguel Hidalgo Mexico D.F
U.S.A	1-800-SAMSUNG (726-7864)	www.samsung.com	Samsung Electronics America, Inc. 105 Challenger Road Ridgefield Park, NJ 07660-0511

SERIES | 6
650

LCD TV user manual

imagine the possibilities

Thank you for purchasing this Samsung product.
To receive more complete service, please register
your product at

www.samsung.com/register

Model _____ Serial No. _____



Figures and illustrations in this User Manual are provided for reference only and may differ from actual product appearance. Product design and specifications may be changed without notice.

Important Warranty Information Regarding Television Format Viewing

 See the warranty card for more information on warranty terms.

Wide screen format LCD Displays (16:9, the aspect ratio of the screen width to height) are primarily designed to view wide screen format full-motion video. The images displayed on them should primarily be in the wide screen 16:9 ratio format, or expanded to fill the screen if your model offers this feature and the images are constantly moving. Displaying stationary graphics and images on screen, such as the dark sidebars on nonexpanded standard format television video and programming, should be limited to no more than 5% of the total television viewing per week.

Additionally, viewing other stationary images and text such as stock market reports, video game displays, station logos, web sites or computer graphics and patterns, should be limited as described above for all televisions. Displaying stationary images that exceed the above guidelines can cause uneven aging of LCD Displays that leave subtle, but permanent burned-in ghost images in the LCD picture. To avoid this, vary the programming and images, and primarily display full screen moving images, not stationary patterns or dark bars. On LCD models that offer picture sizing features, use these controls to view different formats as a full screen picture.

Be careful in the selection and duration of television formats used for viewing. Uneven LCD aging as a result of format selection and use, as well as burned-in images, are not covered by your Samsung limited warranty.

• SAMSUNG ELECTRONICS NORTH AMERICAN LIMITED WARRANTY STATEMENT

Subject to the requirements, conditions, exclusions and limitations of the original Limited Warranty supplied with Samsung Electronics (SAMSUNG) products, and the requirements, conditions, exclusions and limitations contained herein, SAMSUNG will additionally provide Warranty Repair Service in the United States on SAMSUNG products purchased in Canada, and in Canada on SAMSUNG products purchased in the United States, for the warranty period originally specified, and to the Original Purchaser only.

The above described warranty repairs must be performed by a SAMSUNG Authorized Service Center. Along with this Statement, the Original Limited Warranty Statement and a dated Bill of Sale as Proof of Purchase must be presented to the Service Center. Transportation to and from the Service Center is the responsibility of the purchaser. Conditions covered are limited only to manufacturing defects in material or workmanship, and only those encountered in normal use of the product.

Excluded, but not limited to, are any originally specified provisions for, in-home or on-site services, minimum or maximum repair times, exchanges or replacements, accessories, options, upgrades, or consumables.

For the location of a SAMSUNG Authorized Service Center, please call toll-free:

– In the United States : 1-800-SAMSUNG (1-800-726-7864)

– In Canada : 1-800-SAMSUNG

Still image warning

Avoid displaying still images (such as jpeg picture files) or still image elements (such as TV channel logos, panorama or 4:3 image format, stock or news bars at screen bottom etc.) on the screen. Constant displaying of still pictures can cause uneven wear of the screen, which will affect image quality. To reduce risk of this effect, please follow below recommendations:

- Avoid displaying the same TV channel for long periods.
- Always try to display a full screen image.
- Reducing brightness and contrast will help to avoid the appearance of after-images.
- Use all TV features designed to reduce image retention and screen burn, refer to proper user manual section for details.

Securing the Installation Space

Keep the required distances between the product and other objects (e.g. walls) to ensure proper ventilation.

Failing to do so may result in fire or a problem with the product due to an increase in the internal temperature of the product.

 When using a stand or wall-mount, use parts provided by Samsung Electronics only.

- If you use parts provided by another manufacturer, it may result in a problem with the product or an injury due to the product falling.

 The appearance may differ depending on the product.

Installation with a stand.

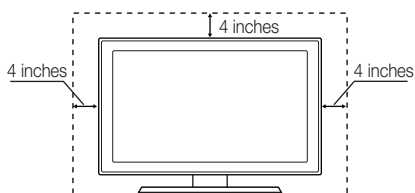

Installation with a wall-mount.

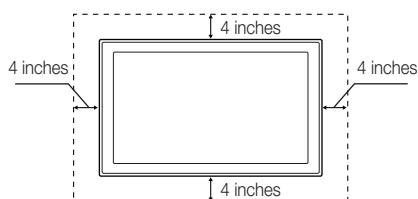

Contents

Getting Started

- List of Features 4
- Accessories 4
- Viewing the Control Panel 5
- Install the Stand 6
- Viewing the Remote Control 7
- Connecting to an Antenna 8
- Plug & Play (Initial Setup) 8

Connections

- Connecting to an AV Device 9
- Connecting to an Audio Device 11
- Connecting to a PC 12
- Changing the Input Source 13

Basic Features

- How to Navigate Menus 13
- Channel Menu 14
 - Seeing Channels 14
 - Using Favorite Channels 14
 - Memorizing Channels 14
 - Editing Channels 15
 - Other Features 15
- Picture Menu 16
 - Changing the Preset Picture Mode 16
 - Adjusting Picture Settings 16
 - Economical Solutions 16
 - Changing the Picture Options 17
 - Setting up the TV with your PC 19
- Sound Menu 19
 - Changing the Preset Sound Mode 19
 - Adjusting sound settings 19
 - Sound Settings 20
- Setup Menu 20
 - Setting the Time 20
 - Using the Sleep Timer 21
 - Setting the On/Off Timer 21
 - Locking Programs 21
 - Other Features 23
 - Picture In Picture (PIP) 24
- Support Menu 24

Advanced Features

- Network Connection 26
 - Connecting to a Wired Network 26
 - Connecting to a Wireless Network 28
- Media Play 32
 - Connecting a USB Device 32
 - Connecting to your PC through a network 32
 - Screen Display 34
 - Playing Multiple Files 37
 - Media Play - Additional Functions 37
- Anynet+ 39
 - Setting Up Anynet+ 40
 - Switching between Anynet+ Devices 40
 - Recording 40
 - Listening through a Receiver 41
 - Troubleshooting for Anynet+ 41
- Internet@TV 42
 - Getting Started with Internet@TV 42
 - Setting up Internet@TV 43
 - Using the Internet@TV service 45
 - PROFILE Widget 47
 - Widget Gallery 47
 - Troubleshooting for internet@TV 48
 - Help Website 48
- AllShare 49
 - About AllShare 49
 - Setting Up AllShare 49

Other Information

- Installing the Wall Mount 51
- Assembling the Cables 52
- Anti-theft Kensington Lock 52
- Securing the TV to the Wall 53
- Troubleshooting 54
 - License 56
- Specifications 57
- Dimensions 58
- Index 59

ENGLISH

Check the Symbol!



TOOLS



This function can be used by pressing the TOOLS button on the remote control.



Note

Indicates additional information.



Step by Step Guide

Check here for instructions on how to open the relevant submenu within the OSD (on screen display).

Getting Started

List of Features

- **Excellent Digital Interface & Networking:** With a built-in HD digital tuner, nonsubscription HD broadcasts can be viewed without a cable box / STB (Set-Top-Box) satellite receiver.
- **Media Play:** Allows you to play music files, pictures, and movies saved on a USB device (p. 32).
- **Internet@TV:** You can use various internet services and view useful information and entertaining content (p. 42).
- **AllShare:** AllShare connects your TV and compatible Samsung mobile phones/devices through a network (p. 49).
- **Self Diagnosis:** You can check to make sure picture and sound operate normally (p. 25).

Accessories

 Please make sure the following items are included with your LCD TV. If any items are missing, contact your dealer.

 The items' colors and shapes may vary depending on the models.

- Remote Control (BN59-01042A) & Batteries (AAA x 2)
- Owner's Instructions
- Warranty Card / Safety Guide / Quick Setup Guide
- Cleaning Cloth (BN63-01798B)
- Power Cord

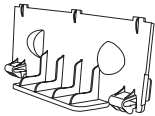

Blanking Bracket
(BN63-06339A)



32~40 inch: (M6xL16)
46~55 inch: (M8xL19)

TV-Holder & Screw (1EA)

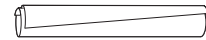

Cable Tie
(BN61-05596A)





Holder-Ring (4EA) (46 ~ 55 inch TVs)
BN61-04529A

Viewing the Control Panel

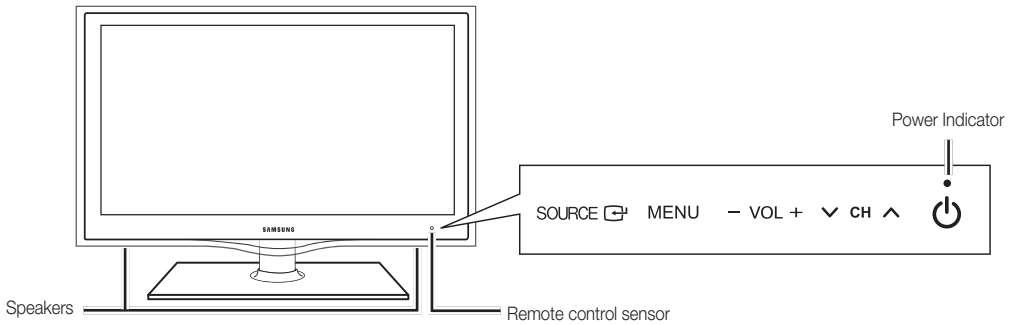
 The product color and shape may vary depending on the model.



 (Power)	Turns the TV on or off.
Remote control sensor	Aim the remote control towards this spot on the TV.
SOURCE 	Toggles between all the available input sources. In the on-screen menu, use this button as you would use the ENTER  button on the remote control.
MENU	Displays an on-screen menu, the OSD (on screen display) of your TV's features.
- VOL +	Adjusts the volume. In the OSD, use the - VOL + buttons as you would use the ◀ and ▶ buttons on the remote control.
▼ CH ▲	Changes the channels. In the OSD, use the ▼ CH ▲ buttons as you would use the ▼ and ▲ buttons on the remote control.
Power Indicator	Blinks and turns off when the power is on and lights up in standby mode.

Standby mode

Do not leave your TV in standby mode for long periods of time (when you are away on a holiday, for example). A small amount of electric power is still consumed even when the power button is turned off. It is best to unplug the power cord.

Getting Started

Input Cables (Sold Separately)

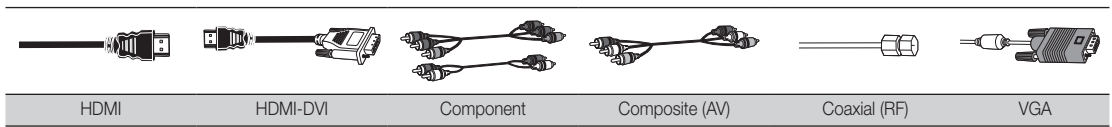

Install the Stand

See separate guide for installing the stand.

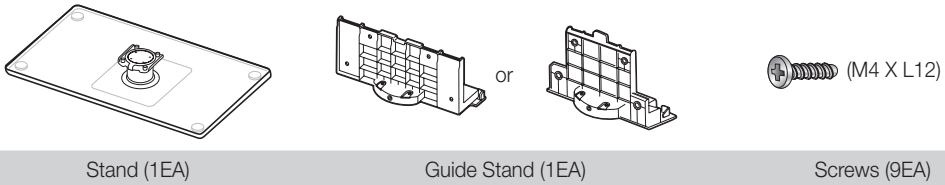

Follow the steps below to connect the TV to the stand.

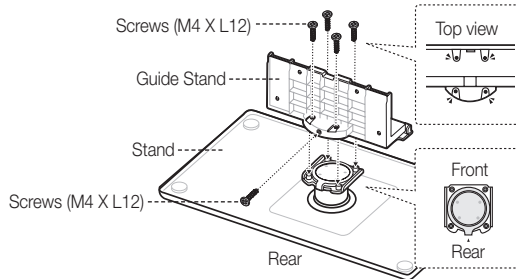

1. Connect the Guide Stand to the Stand using five screws (M4 X L12) as shown.



2. With your TV upright, connect the TV to the Stand as shown.
3. Fasten two screws (M4 X L12) at position ①, and then fasten two screws (M4 X L12) at position ②.

NOTE

- Make sure to distinguish between the front and back of the Stand and Guide Stand when assembling them.
- Make sure that at least two persons lift and move the LCD TV.
- Stand the product up and fasten the screws. If you fasten the screws with the LCD TV placed down, it may lean to one side.

Viewing the Remote Control

 This is a special remote control for the visually impaired and has Braille points on the Power, Channel and Volume buttons.

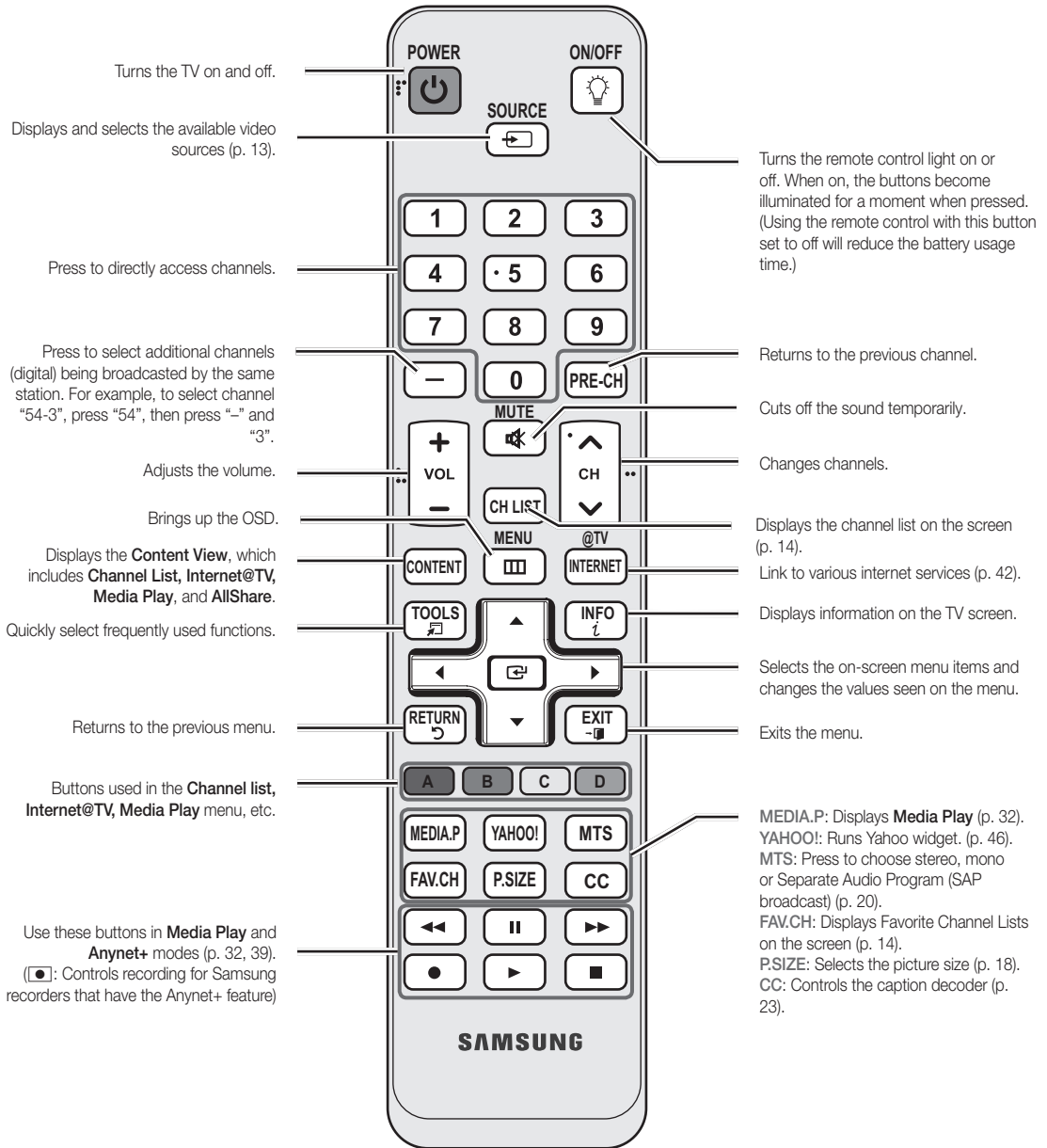

Installing batteries (Battery size: AAA)

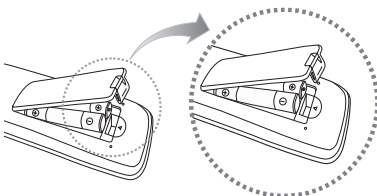

NOTE

- Use the remote control within 23 feet from the TV.
- Bright light may affect the performance of the remote control. Avoid use when nearby fluorescent lights or neon signs.
- The color and shape may vary depending on the model.

Getting Started

Connecting to an Antenna

When the TV is initially powered on, basic settings proceed automatically.



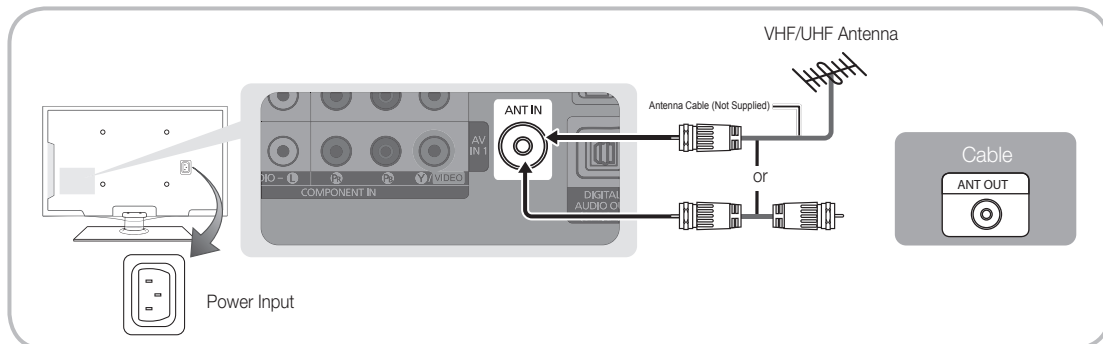





 Connecting the power cord and antenna.





Plug & Play (Initial Setup)

When the TV is initially powered on, a sequence of on-screen prompts will assist in configuring basic settings. Press the **POWER**  button. **Plug & Play** is available only when the **Input** source is set to TV.

 To return to the previous step, press the Red button.

1	Selecting a language	Press the ▲ or ▼ button, then press the ENTER  button. Select the desired OSD (On Screen Display) language.	POWER 
2	Selecting Store Demo or Home Use	Press the ◀ or ▶ button, then press the ENTER  button. <ul style="list-style-type: none"> Select the Home Use mode. Store Demo Mode is for retail environments. To return the unit's settings from Store Demo to Home Use (standard): Press the volume button on the TV. When you see the volume OSD, press and hold MENU for 5 sec. 	
3	Selecting an antenna	Press the ▲ or ▼ button, then press the ENTER  button. Select Air , Cable or Auto .	
4	Selecting a channel	Press the ▲ or ▼ button, then press the ENTER  button. Select the channel source to memorize. When setting the antenna source to Cable , a step appears allowing you to assign numerical values (channel frequencies) to the channels. For more information, refer to Channel → Auto Program (p. 14).  Press the ENTER  button at any time to interrupt the memorization process.	
5	Setting the Clock Mode	Set the Clock Mode automatically or manually. <ul style="list-style-type: none"> Auto: Allows you to select DST (Daylight Saving Time) mode and time zone. Manual: Allows you to manually set the current date and time (p. 21). 	
6	View the HDTV Connection Guide	The connection method for the best HD screen quality is displayed.	
7	Enjoy the TV.	Press the ENTER  button.	

If You Want to Reset This Feature...

 **MENU**  → **Setup** → **Plug & Play** → **ENTER** 

Using an HDMI or HDMI/DVI Cable: HD connection (up to 1080p)

Available devices: DVD, Blu-ray player, HD cable box, HD STB (Set-Top-Box) satellite receiver

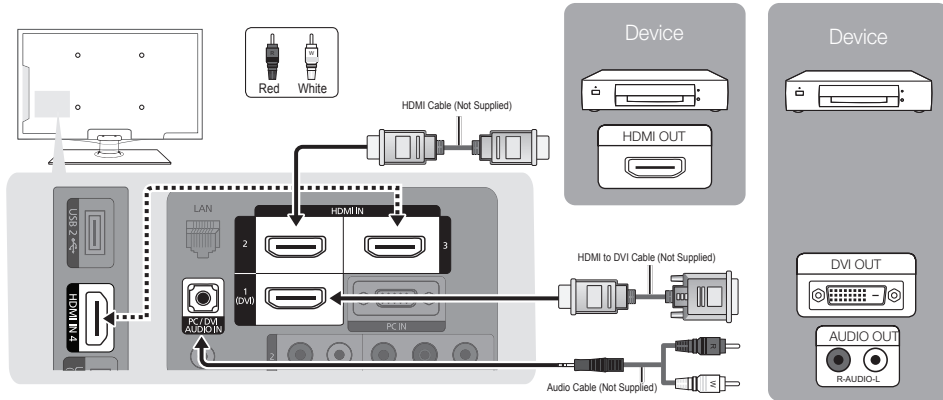

HDMI IN 1(DVI), 2, 3, 4, PC/DVI AUDIO IN

- When using an HDMI/DVI cable connection, you must use the **HDMI IN 1(DVI)** jack for video. A DVD, Blu-ray player, HD cable box, or HD STB satellite receiver may require a DVI-HDMI (DVI to HDMI) cable or DVI-HDMI (DVI to HDMI) adapter. The **PC/DVI AUDIO IN** jack is required for audio.
- If an external device such as a DVD / Blu-ray player / HD cable box / HD STB satellite receiver supporting HDMI versions older than 1.3 is connected, the TV may operate abnormally (e.g. no screen display / no sound / annoying flicker / abnormal color).
- If there is no sound after connecting an HDMI cable, check the HDMI version of the external device. If you suspect the version is older than 1.3, contact the provider of the device to confirm the HDMI version and request an upgrade.
- It is recommended you purchase an HDMI-certified cable. Otherwise, the screen may appear blank or a connection error may occur.

Connections

Using a Component (up to 1080p) or Audio/Video (480i only) Cable

Available devices: DVD, Blu-ray player, cable box, STB satellite receiver, VCR

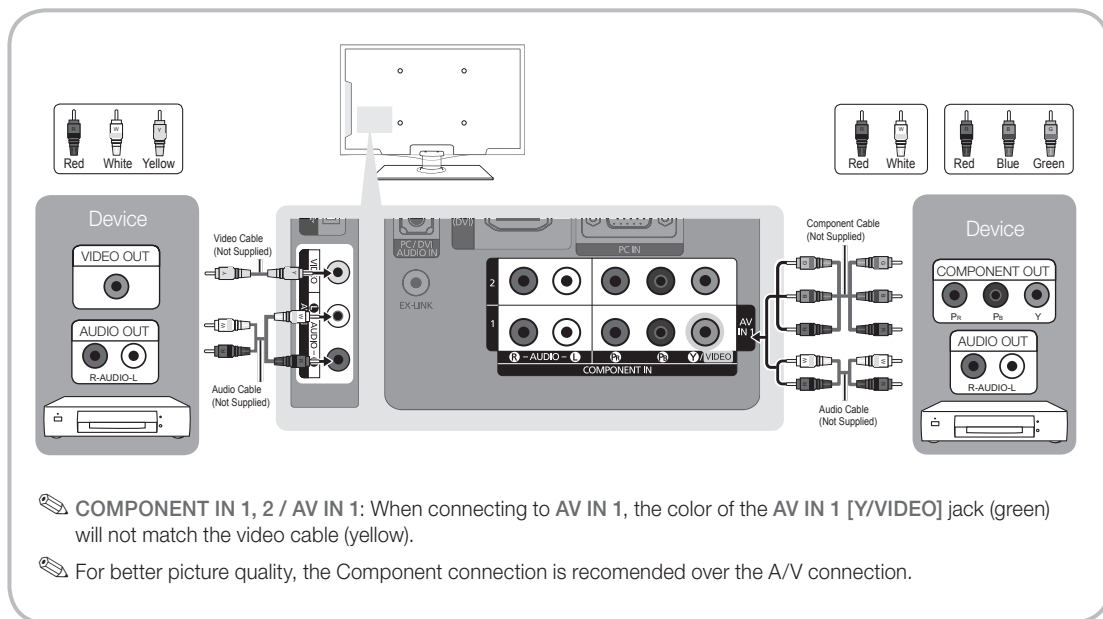

Using an EX-Link Cable Connection

Available Devices: External devices that support EX-Link.

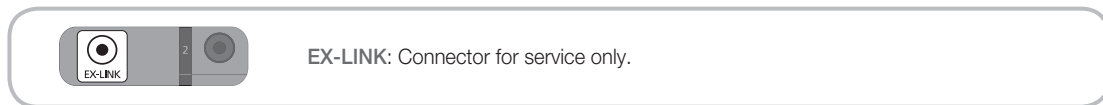

Connecting to an Audio Device

Using an Optical (Digital) or Audio (Analog) Cable Connection

Available devices: Digital Audio System, Amplifier, DVD home theater

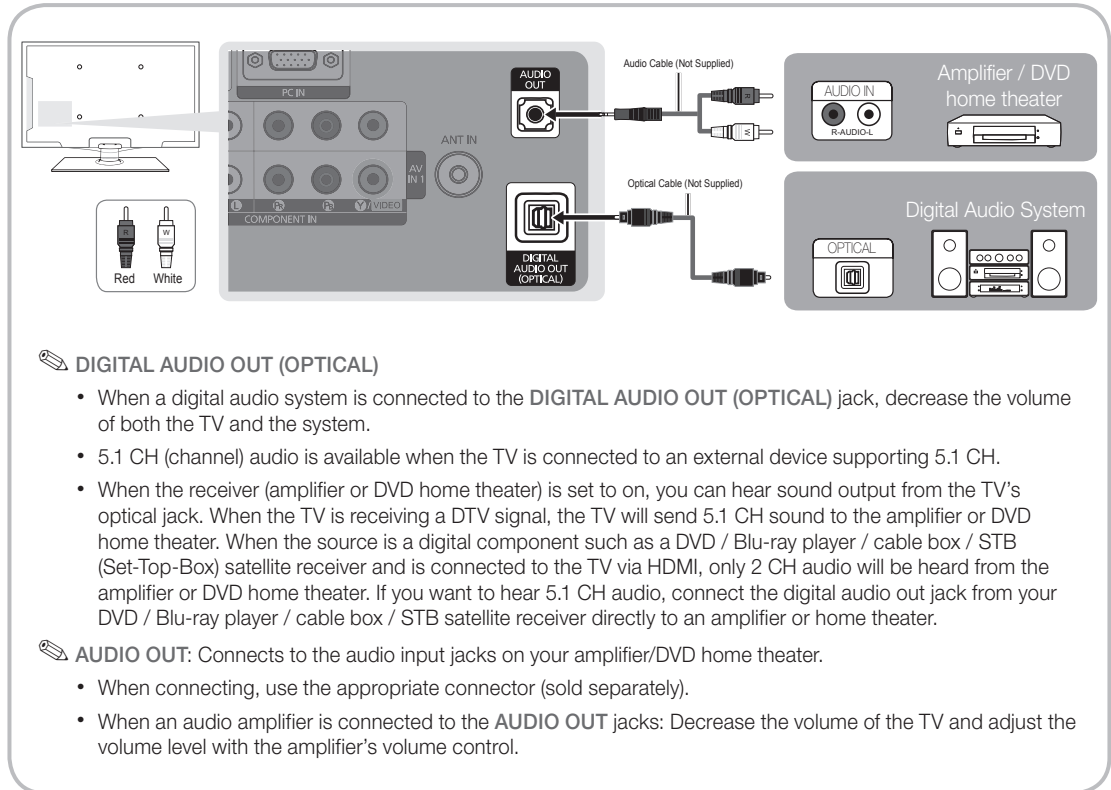

Connections

Connecting to a PC

Using an HDMI/DVI Cable or a D-sub Cable

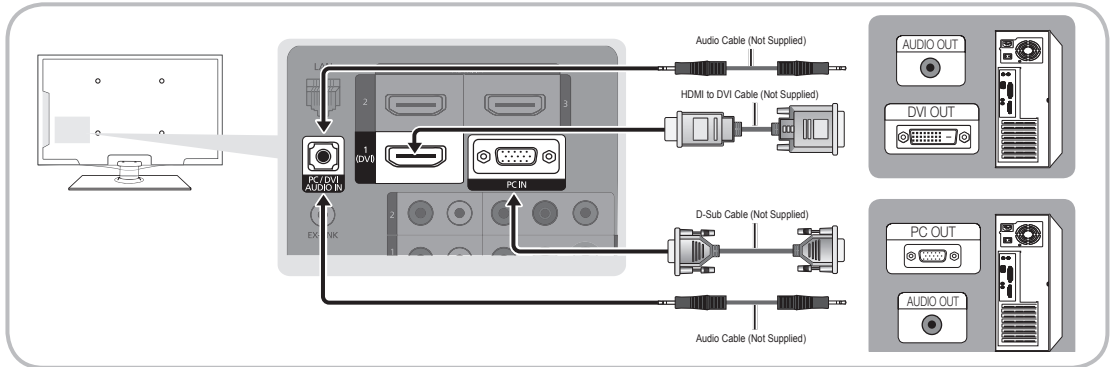

Display Modes (D-Sub and HDMI/DVI Input)

Optimal resolution is 1920 X 1080 @ 60 Hz.

Mode	Resolution	Horizontal Frequency (KHz)	Vertical Frequency (Hz)	Pixel Clock Frequency (MHz)	Sync Polarity (H / V)
IBM	640 x 350	31.469	70.086	25.175	+/-
	720 x 400	31.469	70.087	28.322	-/+
MAC	640 x 480	35.000	66.667	30.240	-/-
	832 x 624	49.726	74.551	57.284	-/-
	1152 x 870	68.681	75.062	100.000	-/-
VESA CVT	720 x 576	35.910	59.950	32.750	-/+
	1152 x 864	53.783	59.959	81.750	-/+
	1280 x 720	56.456	74.777	95.750	-/+
	1280 x 960	75.231	74.857	130.000	-/+
VESA DMT	640 x 480	31.469	59.940	25.175	-/-
	640 x 480	37.861	72.809	31.500	-/-
	640 x 480	37.500	75.000	31.500	-/-
	800 x 600	37.879	60.317	40.000	+/+
	800 x 600	48.077	72.188	50.000	+/+
	800 x 600	46.875	75.000	49.500	+/+
	1024 x 768	48.363	60.004	65.000	-/-
	1024 x 768	56.476	70.069	75.000	-/-
	1024 x 768	60.023	75.029	78.750	+/+
	1152 x 864	67.500	75.000	108.000	+/+
	1280 x 1024	63.981	60.020	108.000	+/+
	1280 x 1024	79.976	75.025	135.000	+/+
	1280 x 720	45.000	60.000	74.250	+/+
	1280 x 800	49.702	59.810	83.500	-/+
	1280 x 800	62.795	74.934	106.500	-/+
	1280 x 960	60.000	60.000	108.000	+/+
1360 x 768	47.712	60.015	85.500	+/+	
1440 x 900	55.935	59.887	106.500	-/+	
1440 x 900	70.635	74.984	136.750	-/+	
1680 x 1050	65.290	59.954	146.250	-/+	
VESA GTF	1280 x 720	52.500	70.000	89.040	-/+
	1280 x 1024	74.620	70.000	128.943	-/-
VESA DMT / DTV CEA	1920 x 1080p	67.500	60.000	148.500	+/+

NOTE

- For HDMI/DVI cable connection, you must use the **HDMI IN 1(DVI)** jack.
- The interlace mode is not supported.
- The set may operate abnormally if a non-standard video format is selected.
- Separate and Composite modes are supported. SOG(Sync On Green) is not supported.

Changing the Input Source

Source List

Use to select TV or an external input sources such as a DVD / Blu-ray player / cable box / STB satellite receiver.



MENU → Input → Source List → ENTER

■ TV / PC / AV1 / AV2 / Component1 / Component2 / HDMI1/DVI / HDMI2 / HDMI3 / HDMI4 / USB

You can only choose external devices that are connected to the TV. In the **Source List**, connected inputs will be highlighted.

In the **Source List**, **PC** is always activated.

Edit Name

MENU → Input → Edit Name → ENTER

■ VCR / DVD / Cable STB / Satellite STB / PVR STB / AV Receiver / Game / Camcorder / PC / DVI PC / DVI Devices / TV / IPTV / Blu-ray / HD DVD / DMA: Name the device connected to the input jacks to make your input source selection easier.

When a PC with a resolution of 1920 x 1080 @ 60Hz is connected to the **HDMI IN 1(DVI)** port, you should set to **DVI PC** mode under **Edit Name**.

When connecting an HDMI/DVI cable to the **HDMI IN 1(DVI)** port, you should set to **DVI PC** to **DVI devices** mode under **Edit Name**.

Basic Features

How to Navigate Menus

Before using the TV, follow the steps below to learn how to navigate the menu and select and adjust different functions.

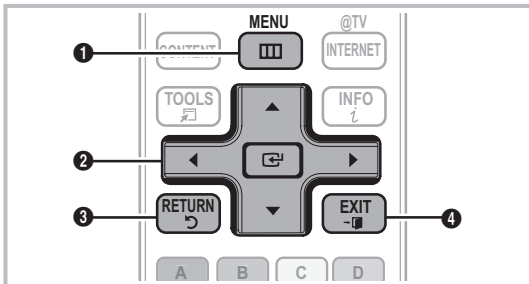

- 1 MENU button: Displays the main on-screen menu.
- 2 ENTER / Direction button: Move the cursor and select an item. Confirm the setting.
- 3 RETURN button: Returns to the previous menu.
- 4 EXIT button: Exits the on-screen menu.

How to Operate the OSD (On Screen Display)

The access step may differ depending on the selected menu.

1	MENU	The main menu options appear on the screen: Picture, Sound, Channel, Setup, Input, Application, Support.
2	▼ / ▲	Select an icon with the ▲ or ▼ button.
3	ENTER	Press ENTER to access the sub-menu.
4	▲ / ▼	Select the desired submenu with the ▲ or ▼ button.
5	◀ / ▶	Adjust the value of an item with the ◀ or ▶ button. The adjustment in the OSD may differ depending on the selected menu.
6	ENTER	Press ENTER to confirm the selection.
7	EXIT	Press EXIT.

Basic Features

Channel Menu

Seeing Channels





Channel List

Add, delete or set Favorite channels and use the program guide for digital broadcasts.

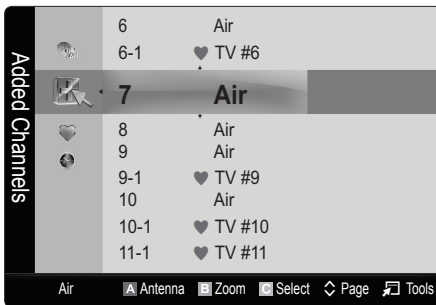



 MENU  → Channel → Channel List → ENTER 

Select a channel in the **All Channels**, **Added Channels**, **Favorite** or **Programmed** screen by pressing the ▲ / ▼ and ENTER  buttons. Then you can watch the selected channel.



-  **All Channels**: Shows all currently available channels.
-  **Added Channels**: Shows all added channels.
-  **Favorite**: Shows all favorite channels.
-  **Programmed**: Shows all currently reserved programs.



 Using the color buttons with the **Channel List**

-  **Red (Antenna)**: Switches to **Air** or **Cable**.
-  **Green (Zoom)**: Enlarges or shrinks a channel number.
-  **Yellow (Select)**: Selects multiple channel lists. Select desired channels and press the Yellow button to set all the selected channels at the same time. The ✓ mark appears to the left of the selected channels.
-  **(Page)**: Move to next or previous page.
-  **(Tools)**: Displays the **Channel List** option menu. (The Options menus may differ depending on the situation.)

Channel Status Display Icons

Icons	Operations
✓	A channel selected.
♥	A channel set as a Favorite.
⌚	A reserved Program.

Using Favorite Channels

 MENU  → Channel → Channel List → ENTER 

Add to Favorite / Delete from Favorite

TOOLS 

Set channels you watch frequently as Favorites.

1. Select a channel and press the **TOOLS** button.
2. Add or delete a the channel using the **Add to Favorite** or **Delete from Favorite** menu respectively.

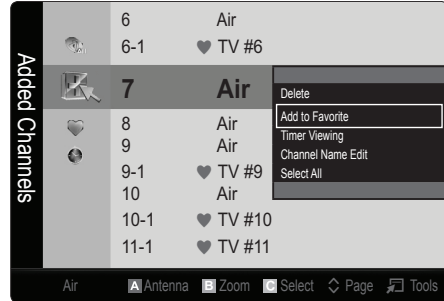

To show all Favorite channels, click on the button shown on the right.



Memorizing Channels

 MENU  → Channel → ENTER 

Antenna (Air / Cable) **TOOLS**

Before your television can begin memorizing the available channels, you must specify the type of signal source that is connected to the TV (i.e. an Air or a Cable system).



Auto Program

- **Air**: Air antenna signal.
- **Cable**: Cable antenna signal.
- **Auto**: Air and Cable antenna.

 NOTE

- When selecting the Cable TV system: **STD**, **HRC** and **IRC** identify various types of cable TV systems. Contact your local cable company to identify the type of cable system that exists in your particular area. At this point, the signal source has been selected.
- After all the available channels are stored, it starts to remove scrambled channels. The Auto program menu then reappears.

Editing Channels

 MENU  → Channel → Channel List → ENTER 

Channel Name Edit

1. Select a channel and press the **TOOLS** button.
 2. Edit the channel name using the **Channel Name Edit** menu.
- **Channel Name Edit** (analog channels only): Assign your own channel name.



Other Features

 MENU  → Channel → ENTER 

Clear Scrambled Channel

This function is used to filter out scrambled channels after Auto Program is completed. This process may take up to 20~30 minutes.

How to Stop Searching Scrambled Channels

1. Press the ENTER  button to select **Stop**.
2. Press the ◀ button to select **Yes**.
3. Press the ENTER  button.

 This function is only available in **Cable** mode.

Channel List

 MENU  → Channel → Channel List → ENTER 

Channel List Option Menu

Set each channel using the Channel List menu options (**Add/Delete**, **Timer Viewing**, **Select All/ Deselect All**). Option menu items may differ depending on the channel status.

1. Select a channel and press the **TOOLS** button.
 2. Select a function and change its settings.
- **Add / Delete**: Delete or add a channel to display the channels you want.

 NOTE

- All deleted channels will be shown on the **All Channels** menu.
- A gray-colored channel indicates the channel has been deleted.
- The **Add** menu only appears for deleted channels.
- Delete a channel from the **Added Channels** or **Favorite** menu in the same manner.

- **Timer Viewing**: You can set a desired channel to be displayed automatically at the reserved time. Set the current time first to use this function.

1. Press the ◀ / ▶ / ▲ / ▼ buttons to select the desired channel in **Channel List**.
2. Press the **TOOLS** button, then select **Timer Viewing**.
3. Scroll up or down to adjust the settings in the box, or use the numeric buttons on your remote for entering the date and time.

 If you selected **Once**, **Every Week** or **Every Day** in **Repeat**, you can enter the date you want.

4. Select **OK**, then press the ENTER  button when done.

 NOTE

- Only memorized channels can be reserved.
- Reserved programs will be displayed in the **Programmed** menu.
- When a digital channel is selected, press the ▶ button to view the digital program.

- **Select All**: Select all the channels in the channel list.

- **Deselect All**: Deselect all the selected channels.

 You can only select **Deselect All** when one or more channels are selected.

Programmed

(in Channel List)

You can view, modify or delete a show you have reserved to watch. **Programmed** timer viewing is displayed here. Highlight a program and press the **TOOLS** button to display Options.

- **Change Info**: Change a show you have reserved to watch. Begin with step 3 of “Timer Viewing” above.

- **Cancel Schedules**: Cancel a show you have reserved to watch.

 This deletes the highlighted or selected program(s).

Basic Features

- **Information:** Display a show you have reserved to watch. (You can also change the reservation Information.)
 - ✎ Alternatively, you can view Information by highlighting a program and pressing the **ENTER** button.
- **Select All / Deselect All:** Select or deselect all reserved programs.

Fine Tune

(analog channels only)

If the reception is clear, you do not have to fine tune the channel, as this is done automatically during the search and store operation. If the signal is weak or distorted, fine tune the channel manually. Scroll to the left or right until the image is clear.

- ✎ Settings are applied to the channel your currently watching.
- ✎ Fine tuned channels that have been saved are marked with an asterisk "*" on the right-hand side of the channel number in the channel banner.
- ✎ To reset the fine-tuning, select **Reset**.

Picture Menu

Changing the Preset Picture Mode

 **MENU** → **Picture** → **Mode** → **ENTER**

Mode TOOLS

Select your preferred picture type.

- **Dynamic:** Suitable for a bright room.
- **Standard:** Suitable for a normal environment.
- **Natural:** Suitable for reducing eye strain.
 - ✎ **Natural** is not available in PC mode.
- **Movie:** Suitable for watching movies in a dark room.

Adjusting Picture Settings

Backlight / Contrast / Brightness / Sharpness / Color / Tint (G/R)

 **MENU** → **Picture** → **ENTER**

Your television has several setting options for picture quality control.

NOTE

- When you make changes to **Backlight, Contrast, Brightness, Sharpness, Color** or **Tint (G/R)**, the OSD will be adjusted accordingly.
- In PC mode, you can only make changes to **Backlight, Contrast** and **Brightness**.
- Settings can be adjusted and stored for each external device connected to the TV.
- Lowering picture brightness reduces power consumption.

Economical Solutions

Eco Solution

 **MENU** → **Picture** → **Eco Solution** → **ENTER**

- **Energy Saving (Off / Low / Medium / High / Picture Off / Auto):** This adjusts the brightness of the TV in order to reduce power consumption. If you select **Picture Off**, the screen is turned off, but the sound remains on. Press any button to turn on the screen again.
- **Eco Sensor (Off / On):** To enhance your power savings; the picture settings will automatically adapt to the light in the room.
 - ✎ If you adjust the **Backlight**, the **Eco Sensor** will be set to **Off**.
 - Min Backlight:** When **Eco sensor** is **On**, the minimum screen brightness can be adjusted manually.
 - ✎ If **Eco Sensor** is **On**, the display brightness may change (become slightly darker in most cases) depending on the surrounding light intensity.
- **No Signal Power Off (Off / 15 min. / 30 min. / 60 min.):** To avoid unnecessary energy consumption, set how long you want the TV to remain on if it's not receiving a signal.
 - ✎ Disabled when the PC is in power saving mode.

Changing the Picture Options

Advanced Settings

 MENU  → Picture → Advanced Settings → ENTER 

(Advanced Settings are available in **Standard / Movie** mode)

Compared to previous models, new Samsung TVs have a more precise picture.

 In PC mode, you can only make changes to **Dynamic Contrast, Gamma and White Balance.**

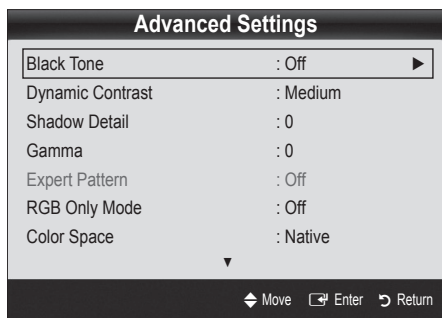

- **Black Tone (Off / Dark / Darker / Darkest):** Select the black level to adjust the screen depth.
- **Dynamic Contrast (Off / Low / Medium / High):** Adjust the screen contrast.
- **Shadow Detail (-2~+2):** Increase the brightness of dark images.
- **Gamma:** Adjust the primary color intensity.
- **Expert Pattern (Off / Pattern 1 / Pattern 2)**

Running the **Expert Pattern** function, the picture can be calibrated. If the OSD menu disappears or a menu other than the **Picture** menu is opened, the calibration is saved and the **Expert Pattern** window disappears.

Off: Turns the **Expert Pattern** function off.

Pattern 1: This is a test screen designed to demonstrate the affects of display settings on shades.

Pattern 2: This is a test screen designed to demonstrate the affects of display settings on colors.

 After selecting **Pattern 1** or **Pattern 2**, you can adjust any of the advanced settings to the desired effect.

 While the **Expert Pattern** is running, sound is not output.

 Only enabled in DTV, Component and HDMI modes.

- **RGB Only Mode (Off / Red / Green / Blue):** Displays the **Red, Green** and **Blue** color for making fine adjustments to the hue and saturation.
- **Color Space (Auto / Native / Custom):** Adjust the range of colors available to create the image. To adjust **Color, Red, Green, Blue** and **Reset**, set **Color Space** to **Custom**.
- **White Balance:** Adjust the color temperature for a more natural picture.
R-Offset / G-Offset / B-Offset: Adjust each color's (red, green, blue) darkness.
R-Gain / G-Gain / B-Gain: Adjust each color's (red, green, blue) brightness.
Reset: Resets the **White Balance** to it's default settings.
- **10p White Balance (Off / On):** Controls the white balance in 10 point intervals by adjusting the red, green, and blue brightness.

 Available when the picture mode is set to **Movie** and when the external input is set to HDMI or Component.

 Some external devices may not support this function.

Interval: Select interval to adjust.

Red: Adjust the red level.

Green: Adjust the green level.

Blue: Adjust the blue level.

Reset: Resets the 10p White Balance to its default settings.



- **Flesh Tone:** Emphasize pink "Flesh Tone."
- **Edge Enhancement (Off / On):** Emphasize object boundaries.
- **xvYCC (Off / On):** Setting the **xvYCC** mode on increases detail and color space when watching movies from an external device (e.g. BD/DVD player) connected to the HDMI or Component IN jacks.

 Available when the picture mode is set to **Movie** and when the external input is set to HDMI or Component.

 Some external devices may not support this function.

Basic Features

Picture Options

 MENU  Picture → Picture Options → ENTER 

 In PC mode, you can only make changes to the **Color Tone**, **Size**, **Digital Noise Filter** and **Auto Protection Time**.

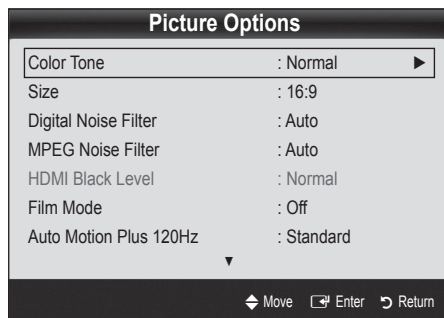

■ Color Tone (Cool / Normal / Warm1 / Warm2)

 **Warm1** or **Warm2** will be deactivated when the picture mode is **Dynamic**.

 Settings can be adjusted and stored for each external device connected to an input on the TV.

■ **Size:** Your cable box/satellite receiver may have its own set of screen sizes as well. However, we highly recommend you use 16:9 mode most of the time.

16:9 : Sets the picture to 16:9 wide mode.

Zoom1 : Use for moderate magnification.

Zoom2 : Use for a stronger magnification.

Wide Fit : Enlarges the aspect ratio of the picture to fit the entire screen.



4:3 : Sets the picture to basic (4:3) mode.

 Do not watch in 4:3 format for a long time. Traces of borders displayed on the left, right and center of the screen may cause image retention (screen burn) which are not covered by the warranty.

Screen Fit : Displays the full image without any cut-off when HDMI (720p / 1080i / 1080p) or Component (1080i / 1080p) signals are inputted.



NOTE

• After selecting **Zoom1**, **Zoom2** or **Wide Fit**:

1. Press the **▶** button to select **Position**.
2. Press the ENTER  button.
3. Press the **▲** or **▼** button to move the picture up or down.
4. Press the ENTER  button.
5. Press the **▶** button to select **Reset**.
6. Press the ENTER  button to reset the picture to its default position.



• After selecting **Screen Fit** in HDMI (1080i/1080p) or Component (1080i/1080p) mode, you may need to center the picture:

1. Press the **◀** or **▶** button to select **Position**.
2. Press the ENTER  button.
3. Press the **▲**, **▼**, **◀** or **▶** button to move the picture.
4. Press the ENTER  button.
5. Press the **◀** or **▶** button to select **Reset**.
6. Press the ENTER  button.

• HD (High Definition): 16:9 - 1080i/1080p (1920x1080), 720p (1280x720)

• Settings can be adjusted and stored for each external device you have connected to an input on the TV.

Input Source	Picture Size
ATV, AV, Component (480i, 480p)	16:9, Zoom1, Zoom2, 4:3
DTV(1080i), Component (1080i, 1080p), HDMI (720p, 1080i, 1080p)	16:9, 4:3, Wide Fit, Screen Fit
PC	16:9, 4:3

■ **Digital Noise Filter (Off / Low / Medium / High / Auto / Auto Visualization):** If the broadcast signal received by your TV is weak, you can activate the **Digital Noise Filter** feature to reduce any static and ghosting that may appear on the screen.

 When the signal is weak, try other options until the best picture is displayed.

Auto Visualization: When changing analog channels, displays signal strength.

 Only available for analog channels.

 When bar is green, you are receiving the best possible signal.

■ **MPEG Noise Filter (Off / Low / Medium / High / Auto):** Reduces MPEG noise to provide improved picture quality.

■ **HDMI Black Level (Normal / Low):** Selects the black level on the screen to adjust the screen depth.

 Available only in HDMI mode.

■ **Film Mode (Off / Auto1 / Auto2):** Sets the TV to automatically sense and process film signals from all sources and adjusts the picture for optimum quality.

 Available in TV, AV, COMPONENT (480i / 1080i) and HDMI (480i / 1080i).

- **Auto Motion Plus 120Hz (Off / Clear / Standard / Smooth / Custom / Demo):** Removes drag from fast scenes with a lot of movement to provide a clearer picture.

 If noise occurs on the screen, please set the **Auto Motion Plus 120Hz** to **Off**. If **Auto Motion Plus 120Hz** is **Custom**, you can set up the **Blur Reduction**, **Judder Reduction** or **Reset** manually.

 If **Auto Motion Plus 120Hz** is **Demo**, you can compare the difference between on and off modes.

Blur Reduction: Adjusts the blur reduction level from video sources.

Judder Reduction: Adjusts the judder reduction level from video sources when playing films.

Reset: Reset the custom settings.

- **Auto Protection Time (2 hours / 4 hours / 8 hours / 10 hours / Off):** Set the time the screen remains idle with a still image until the screen saver is activated. The screen saver prevents the formation of ghost images on the screen.

Picture Reset (OK / Cancel)

Resets your current picture mode to its default settings.

Setting up the TV with your PC

Set the input source to PC.

 MENU  → **Picture** → ENTER 

Auto Adjustment

Adjust frequency values/positions and fine tune the settings automatically.

 Not available when connecting with an HDMI/DVI cable.

Screen

- **Coarse / Fine:** Removes or reduces picture noise. If the noise is not removed by Fine-tuning alone, then adjust the frequency as best as possible (**Coarse**) and Fine-tune again. After the noise has been reduced, readjust the picture so that it is aligned to the center of screen.
- **Position:** Adjust the PC's screen positioning if it does not fit the TV screen. Press the ▲ or ▼ button to adjust the Vertical-Position. Press the ◀ or ▶ button to adjust the Horizontal-Position.
- **Image Reset:** Resets the image to default settings.

Using Your TV as a Computer (PC) Display

Setting Up Your PC Software (Based on Windows XP)

Depending on the version of Windows and the video card, the actual screens on your PC will probably look different, but the same basic set-up information will apply in most cases. (If not, contact your computer manufacturer or Samsung Dealer.)

1. Click on "Control Panel" on the Windows start menu.
2. Click on "Appearance and Themes" in the "Control Panel" window and a display dialog-box will appear.
3. Click on "Display" and a display dialog box will appear.
4. Navigate to the "Settings" tab on the display dialog-box.
 - The correct size setting (resolution) [Optimum: 1920 X 1080 pixels]
 - If a vertical-frequency option exists on your display settings dialog box, the correct value is "60" or "60 Hz". Otherwise, just click "OK" and exit the dialog box.

Sound Menu



Changing the Preset Sound Mode

 MENU  → **Sound** → **Mode** → ENTER 

SRS TheaterSound

- **Standard:** Selects the normal sound mode.
- **Music:** Emphasizes music over voices.
- **Movie:** Provides the best sound for movies.
- **Clear Voice:** Emphasizes voices over other sounds.
- **Amplify:** Increase the intensity of high-frequency sound to allow a better listening experience for the hearing impaired.

Adjusting sound settings

 MENU  → **Sound** → **Equalizer** → ENTER 



Equalizer

Adjusts the sound mode (standard sound mode only).

- **Balance L/R:** Adjusts the balance between the right and left speaker.
- **100Hz / 300Hz / 1KHz / 3KHz / 10KHz (Bandwidth Adjustment):** Adjusts the level of specific bandwidth frequencies.
- **Reset:** Resets the equalizer to its default settings.

Basic Features

Sound Settings

 MENU  → Sound → ENTER 

SRS TruSurround HD (Off / On)

(standard sound mode only)

This function provides a virtual 5.1 channel surround sound experience through a pair of speakers or headphones using HRTF (Head Related Transfer Function) technology.

SRS TruDialog (Off / On)

(standard sound mode only)

This function allows you to increase the intensity of a voice over background music or sound effects so that dialog can be heard more clearly.

Preferred Language

(digital channels only)

Digital-TV broadcasts are capable of simultaneous transmission of many audio tracks (for example, simultaneous translations of the program into foreign languages).

 You can only select a language among the ones being broadcasted.



Multi-Track Sound (MTS)

(analog channels only)

- **Mono:** Choose for channels that are broadcasting in mono or if you are having difficulty receiving a stereo signal.
- **Stereo:** Choose for channels that are broadcasting in stereo.
- **SAP:** Choose to listen to the Separate Audio Program, which is usually a foreign-language translation.

 Depending on the particular program being broadcast, you can listen to **Mono**, **Stereo** or **SAP**.



Auto Volume (Off / Normal / Night)

To equalize the volume level on each channel, set to **Normal**.

- **Night:** This mode provides an improved sound experience compared to **Normal** mode, making almost no noise. It is useful at night.

Speaker Select (External Speaker / TV Speaker)

A sound echo may occur due to a difference in decoding speed between the main speaker and the audio receiver. In this case, set the TV to **External Speaker**.

 When **Speaker Select** is set to **External Speaker**, the volume and **MUTE** buttons will not operate and the sound settings will be limited.

 When **Speaker Select** is set to **External Speaker**

- **TV Speaker: Off, External Speaker: On**

 When **Speaker Select** is set to **TV Speaker**

- **TV Speaker: On, External Speaker: On**

 If there is no video signal, both speakers will be mute.

SPDIF Output

SPDIF (Sony Philips Digital Interface) is used to provide digital sound, reducing interference going to speakers and various digital devices such as an A/V Receiver/Home theater.

- **Audio Format:** During the reception of a digital TV broadcast, you can select the Digital Audio output (SPDIF) format from the options **PCM** or **Dolby Digital**.
- **Audio Delay:** Correct audio-video sync problems, when watching TV or video, and when listening to digital audio output using an external device such as an AV receiver (0ms ~ 250ms).

Sound Reset (OK / Cancel)

Reset all sound settings to the factory defaults.

Setup Menu

Setting the Time

 MENU  → Setup → Time → ENTER 

Time

- **Clock:** Setting the clock is for using various timer features of the TV.

 The current time will appear every time you press the **INFO** button.

 If you disconnect the power cord, you have to set the clock again.

Clock Mode (Auto / Manual)

- **Auto:** Set the current time automatically using the time from a digital channel.
 - The antenna must be connected in order to set the time automatically.
- **Manual:** Set the current time manually.
 - Depending on the broadcast station and signal, the auto time set up may not be correct. In this case, set the time manually.

Clock Set: Set the **Month, Day, Year, Hour, Minute** and **am/pm** manually.

- Available only when **Clock Mode** is set to **Manual**.
- You can set the **Month, Day, Year, Hour** and **Minute** directly by pressing the number buttons on the remote control.

Time Zone: Select your time zone.

- This function is only available when the **Clock Mode** is set to **Auto**.

DST (Daylight Saving Time) (Off / On): Switches the Daylight Saving Time function on or off.

- This function is only available when the **Clock Mode** is set to **Auto**.

Using the Sleep Timer

MENU → Setup → Time → Sleep Timer → ENTER

- **Sleep Timer** : Automatically shuts off the TV after a preset period of time. (30, 60, 90, 120, 150 and 180 minutes).
 - To cancel the **Sleep Timer**, select **Off**.

Setting the On/Off Timer

MENU → Setup → Time → Timer 1 → ENTER

- **Timer 1 / Timer 2 / Timer 3:** Three different on / off timer settings can be made. You must set the clock first.

On Time / Off Time: Set the hour, minute, and activate / inactivate. (To activate the timer with the setting you've chosen, set to **Activate**.)

Volume: Set the desired volume level.

Source: Select **TV** or **USB** content to be played when the TV is turned on automatically. (**USB** can be selected only when a USB device is connected to the TV)

Antenna (when the **Source** is set to **TV**): Select **Air** or **Cable**.

Channel (when the **Source** is set to **TV**): Select the desired channel.

Contents (when the **Source** is set to **USB**): Select a folder in the USB device containing music or photo files to be played when the TV is turned on automatically.

NOTE

- If there is no music file on the USB device or the folder containing a music file is not selected, the Timer function does not operate correctly.
- When there is only one photo file in the USB, the Slide Show will not play.
- If a folder name is too long, the folder cannot be selected.
- Each USB you use is assigned its own folder. When using more than one of the same type of USB, make sure the folders assigned to each USB have different names.

Repeat: Select **Once, Everyday, Mon~Fri, Mon~Sat, Sat~Sun** or **Manual** to set at your convenience. If you select **Manual**, you can set up the day you want to activate the timer.

- The mark indicates the day is selected.

- Auto Power Off (available only when the TV is turned on by the Timer): The TV will be automatically turned off after 3 hours of being left idle to prevent overheating.

Locking Programs

MENU → Setup → Security → ENTER

Security

The PIN input screen appears, Enter your 4 digit PIN number.

- **V-Chip:** The V-Chip feature automatically locks out programs that are deemed inappropriate for children. The user must enter a PIN (personal identification number) before any of the V-Chip restrictions are set up or changed.

NOTE

- **V-Chip** is not available in **HDMI, Component** or **PC** mode.
- The default PIN number of a new TV set is "0-0-0-0".
- **Allow All:** Press to unlock all TV ratings.
- **Block All:** Press to lock all TV ratings.

Basic Features

V-Chip Lock (Off / On): You can block rated TV Programs.

TV Parental Guidelines: You can block TV programs depending on their rating. This function allows you to control what your children are watching.

- **TV-Y:** Young children / **TV-Y7:** Children 7 and over / **TV-G:** General audience / **TV-PG:** Parental guidance / **TV-14:** Viewers 14 and over / **TV-MA:** Mature audience
- **ALL:** Lock all TV ratings. / **FV:** Fantasy violence / **V:** Violence / **S:** Sexual situation / **L:** Adult Language / **D:** Sexually Suggestive Dialog

 The **V-Chip** will automatically block certain categories dealing with more sensitive material. For example, if you block the **TV-Y** category, then **TV-Y7** will automatically be blocked. Similarly, if you block the **TV-G** category, then all the categories in the young adult group will be blocked (**TV-G, TV-PG, TV-14** and **TV-MA**). The sub-ratings (**D, L, S, V**) work similarly. So, if you block the **L** sub-rating in **TVPG**, then the **L** sub-ratings in **TV-14** and **TV-MA** will automatically be blocked.

MPAA Rating: You can block movies depending on their MPAA rating. The Motion Picture Association of America(MPAA) has implemented a rating system that provides parents or guardians with advanced information on which films are appropriate for children.

- **G:** General audience (no restrictions). / **PG:** Parental guidance suggested. / **PG-13:** Parents strongly cautioned. / **R:** Restricted. Children under 17 should be accompanied by an adult. / **NC-17:** No children under age 17. / **X:** Adults only. / **NR:** Not rated.

 The **V-Chip** will automatically block any category that deals with more sensitive material. For example, if you block the **PG-13** category, then **R, NC-17** and **X** will automatically be blocked.

Canadian English: You can block TV programs depending on their Anglophone Canadian ratings.

- **C:** Programming intended for children under age 8. / **C8+:** Programming generally considered acceptable for children 8 years and over to watch on their own. / **G:** General programming, suitable for all audiences. / **PG:** Parental Guidance. / **14+:** Programming contains themes or content which may not be suitable for viewers under the age of 14. / **18+:** Adult programming.

 The **V-Chip** will automatically block any category that deals with more sensitive material. For example, if you block the **G** category, then **PG, 14+** and **18+** will automatically be blocked.

Canadian French: You can block TV programs depending on their French Canadian rating.

- **G:** General / **8 ans+:** Programming generally considered acceptable for children 8 years and over to watch on their own. / **13 ans+:** Programming may not be suitable for children under the age of 13. / **16 ans+:** Programming is not suitable for children under the age of 16. / **18 ans+:** Programming restricted to adults.

 The **V-Chip** will automatically block any category that deals with more sensitive material. For example, if you block the **8 ans+** category, then **13 ans+, 16 ans+** and **18 ans+** will automatically be blocked also.

Downloadable U.S. Rating: Parental restriction information can be used while watching DTV channels.

NOTE

- If information is not downloaded from the broadcasting station, the **Downloadable U.S. Rating** menu is deactivated.
 - Parental restriction information is automatically downloaded while watching DTV channels. It may take several seconds.
 - The **Downloadable U.S. Rating** menu is available for use after information is downloaded from the broadcasting station. However, depending on the information from the broadcasting station, it may not be available for use.
 - Parental restriction levels differ depending on the broadcasting station. The default menu name and **Downloadable US Rating** change depending on the downloaded information.
 - Even if you set the on-screen display to another language, the **Downloadable U.S. Rating** menu will appear in English only.
 - The rating will automatically block certain categories that deal with more sensitive material.
 - The rating titles (For example: Humor Level..etc) and TV ratings (For example: DH, MH, H..etc) may differ depending on the broadcasting station.
- **Change PIN:** The Change PIN screen will appear. Choose any 4 digits for your PIN and enter them. As soon as the 4 digits are entered, the **Confirm New PIN** screen appears. Re-enter the same 4 digits. When the Confirm screen disappears, your PIN has been memorized.



How to watch a restricted channel

If the TV is tuned to a restricted channel, the V-Chip will block it. The screen will go blank and the following message will appear:

This channel is blocked by V-Chip. Please enter the PIN to unblock.



 If you forget the PIN, press the remote-control buttons in the following sequence, which resets the pin to "0-0-0-0:" **POWER** (off) → **MUTE** → 8 → 2 → 4 → **POWER**(on)

Other Features

 **MENU**  → **Setup** → **ENTER** 

Menu Language

Set the menu language.

1. Select **Menu Language** and press the **ENTER**  button.
2. Choose desired language and press the **ENTER**  button.

 Choose between **English**, **Español** and **Français**.

Caption

(On-Screen Text Messages)

- **Caption (Off / On):** You can switch the caption function on or off. If captions are not available, they will not be displayed on the screen.

 The Caption feature doesn't work in Component, HDMI or PC modes.

- **Caption Mode:** You can select the desired caption mode.

 The availability of captions depends on the program being broadcast.

Default / CC1~CC4 / Text1~Text4: (analog channels only) The Analog Caption function operates in either analog TV channel mode or when a signal is supplied from an external device to the TV. (Depending on the broadcasting signal, the Analog Caption function may or may not work with digital channels.)

Default / Service1~Service6 / CC1~CC4 / Text1~Text4: (digital channels only) The Digital Captions function works with digital channels.

 **Service1~6** may not be available in digital caption mode depending on the broadcast.



- **Digital Caption Options:** (digital channels only)

Size: Options include Default, Small, Standard and Large. The default is Standard.

Font Style: Options include Default and Styles 0 to 7. The default is Style 0.

Foreground Color: Options include Default, White, Black, Red, Green, Blue, Yellow, Magenta and Cyan. You can change the color of the letter. The default is White.

Background Color: Options include Default, White, Black, Red, Green, Blue, Yellow, Magenta and Cyan. You can change the background color of the caption. The default is Black.

Foreground Opacity: This adjusts the opacity of text. Options include Default, Transparent, Translucent, Solid and Flashing.

Background Opacity: This adjusts the opacity of the caption background. Options include Default, Transparent, Translucent, Solid and Flashing.

Return to Default: This option sets each **Size**, **Font Style**, **Foreground Color**, **Background Color**, **Foreground Opacity** and **Background Opacity** to its default.

NOTE

- **Digital Caption Options** are available only when **Default** and **Service1 ~ Service6** can be selected in Caption Mode.
- The availability of captions depends on the program being broadcasted.
- The **Default** setting follows the standards set by the broadcaster.
- The Foreground and Background cannot be set to have the same color.
- You cannot set both the **Foreground Opacity** and the **Background Opacity** to Transparent.

Network (Network Type / Network Setup / Network Test / Samsung Wireless Link / SWL connect)

For details on set up options, refer to the "Network Connection" instructions (p. 26).

Basic Features

General

- **Game Mode (Off / On):** When connecting to a game console such as PlayStation™ or Xbox™, you can enjoy a more realistic gaming experience by selecting the game mode.

NOTE

- Precautions and limitations for game mode.
 - To disconnect the game console and connect another external device, set **Game Mode** to **Off** in the setup menu.
 - If you display the TV menu in **Game Mode**, the screen shakes slightly.
- **Game Mode** is not available when the input source is set to TV or PC.
- After connecting the game console, set **Game Mode** to **On** to prevent poor picture quality.
- If **Game Mode** is **On**: **Picture** mode is set to **Standard** and **Sound** mode is set to **Movie**.
- Selecting **Reset** after adjusting the equalizer returns the equalizer to its default settings.

- **BD Wise (Off / On):** Provides the optimal picture quality for SAMSUNG DVD, Blu-ray and Home Theater products which support **BD Wise**. When the **BD Wise** is set to **On**, the picture mode is automatically changed to the optimal resolution.

 Available when connecting SAMSUNG products that support **BD Wise** through a HDMI cable.

- **Menu Transparency (Bright / Dark):** Set the Transparency of the menu.
- **Melody (Off / Low / Medium / High):** Set so that a melody plays when the TV is turned on or off.

Wireless Remote Control (Off / On)

Turn on/off or give permission to Samsung mobile phones/ devices.

You must have a Samsung Mobile phone/device which supports **Wireless Remote Control**. For more details, refer to each device's manual.

Picture In Picture (PIP)

PIP







You can watch the TV tuner and one external video source simultaneously. **PIP** (Picture-in-Picture) does not function in the same mode.

 MENU  → Setup → PIP → ENTER 

NOTE

- For PIP sound, refer to the **Sound Select** instructions.
- If you turn the TV off while watching in PIP mode, the PIP window will disappear.
- You may notice that the picture in the PIP window becomes slightly unnatural when you use the main screen to view a game or karaoke.
- While **V-Chip** or **Internet@TV** is in operation, the **PIP** function cannot be used.
- PIP Settings

Main picture	Sub picture
Component, HDMI1/DVI, HDMI2, HDMI3, HDMI4, PC	TV

- **PIP (Off / On):** Activate or deactivate the PIP function.
- **Air/Cable (Air / Cable):** Select either **Air** or **Cable** as the input source for the sub-screen.
- **Channel:** Select the channel for the sub-screen.
- **Size ( / ):** Select a size for the sub-picture.
- **Position ( /  /  / ):** Select a position for the sub-picture.
- **Sound Select (Main / Sub):** You can choose the desired sound (**Main / Sub**) in **PIP** mode.

Support Menu

 MENU  → Support → ENTER 

Legal Notice

 The **Legal Notice** may differ depending on the country.

Self Diagnosis

- **Picture Test:** Use to check for picture problems.

Yes: If the test pattern does not appear or there is noise in the test pattern, select Yes. There may be a problem with the TV. Contact Samsung's Call Center for assistance (1-800-SAMSUNG).

No: If the test pattern is properly displayed, select No. There may be a problem with your external equipment. Please check your connections. If the problem persists, refer to the external device's user manual.
- **Sound Test:** Use the built-in melody sound to check for sound problems.

 If you hear no sound from the TV's speakers, before performing the sound test, make sure **Speaker Select** is set to **TV speaker** in the **Sound** menu.

 The melody will be heard during the test even if **Speaker Select** is set to **External Speaker** or the sound is muted by pressing the **MUTE** button.

Yes: If you can hear sound only from one speaker or not at all during the sound test, select Yes. There may be a problem with the TV. Contact Samsung's Call Center for assistance (1-800-SAMSUNG).

No: If you can hear sound from the speakers, select No. There may be a problem with your external equipment. Please check your connections. If the problem persists, refer to the external device's user manual.
- **Signal Information:** (Digital channels only) An HD channel's reception quality is either perfect or the channels are unavailable. Adjust your antenna to increase signal strength.
- **Troubleshooting:** If the TV seems to have a problem, refer to this description.

 If none of these troubleshooting tips apply, contact the Samsung customer service center.

Software Upgrade

Software Upgrade can be performed by network connection or downloading the latest firmware from "www.samsung.com," to a USB memory device.

Current Version - the software already installed in the TV.

 Software is represented as "Year/Month/Day_Version."

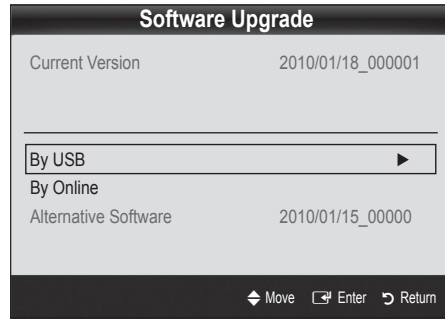



Installing the Latest Version

- **By USB:** Insert a USB drive containing the firmware upgrade file, downloaded from "www.samsung.com," into the TV. Please be careful not to disconnect the power or remove the USB drive until upgrades are complete. The TV will be turned off and on automatically after completing the firmware upgrade. When software is upgraded, video and audio settings you have made will return to their default settings. We advise you to write down your settings so that you can easily reset them after the upgrade.

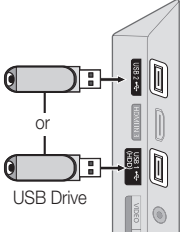
TV Side Panel

- **By Online:** Upgrade the software using the Internet.

 First, configure your network. For detailed procedures on using the Network Setup, refer to the "Network Connection" instructions.

 If the internet connection doesn't operate properly, the connection may be broken. Please retry downloading. If the problem persists, download by USB and upgrade.
- **Alternative Software** (backup): Displays the Software version downloaded through **By Online**. During the Software upgrading, When the Upgrade will discontinue from last step, this function be activated.

HD Connection Guide

Refer to this information when connecting external devices to the TV.

Contact Samsung

View this information when your TV does not work properly or when you want to upgrade the software. You can find information regarding our call centers and how to download products and software.

Advanced Features

Network Connection

You can set up your TV so that it can access the Internet through your local area network (LAN) using a wired or wireless connection.

Connecting to a Wired Network

You can attach your TV to your LAN using cable in three ways:

- You can attach your TV to your LAN by connecting the LAN port on the back of your TV to an external modem using a Cat 5 cable. See the diagram below.

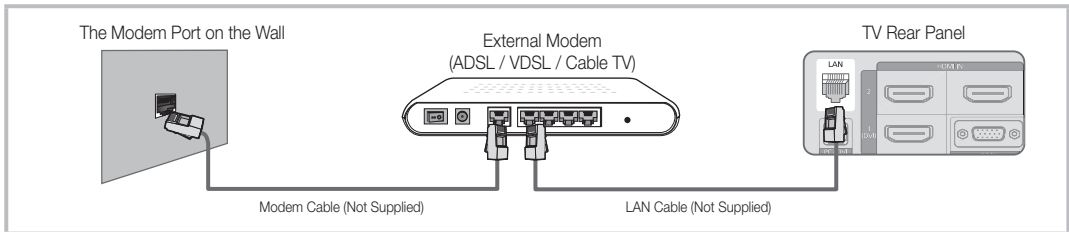

- You can attach your TV to your LAN by connecting the LAN port on the back of your TV to an IP Sharer which is connected to an external modem. Use Cat 5 cable for the connection. See the diagram below.

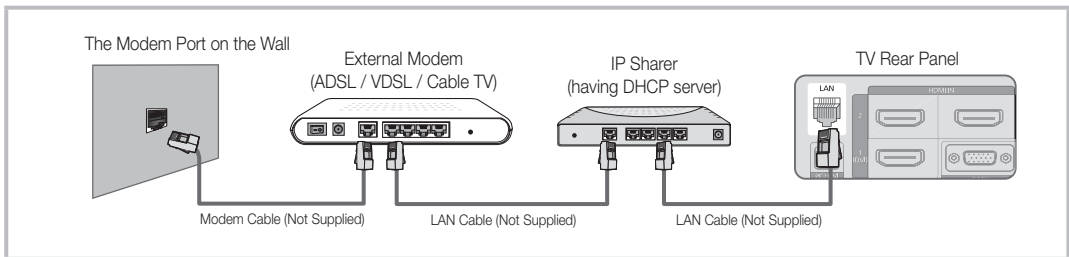

- Depending on how your network is configured, you may be able to attach your TV to your LAN by connecting the LAN port on the back of your TV directly to a network wall outlet using a Cat 5 cable. See the diagram below. Note that the wall outlet is attached to a modem or router elsewhere in your house.

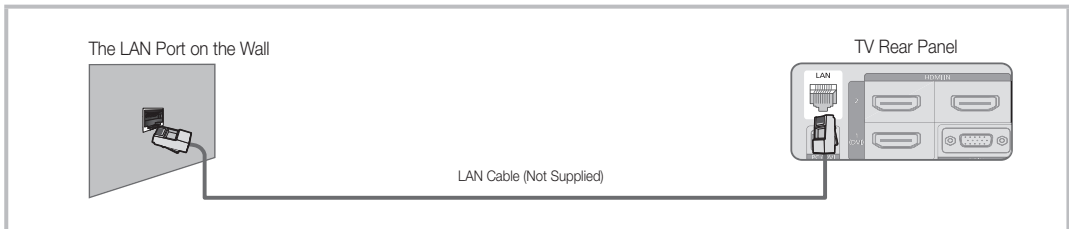

If you have a Dynamic Network, you should use an ADSL modem or router that supports Dynamic Host Configuration Protocol (DHCP). Modems and routers that support DHCP automatically provide the IP address, subnet mask, gateway, and DNS values your TV needs to access the Internet so you don't have to enter them manually. Most home networks are Dynamic Networks.

Some networks require a Static IP address. If your network requires a Static IP address, you must enter the IP address, subnet mask, gateway, and DNS values manually on your TV's Cable Setup Screen when you set up the network connection. To get the IP address, subnet mask, gateway, and DNS values, contact your Internet Service Provider (ISP). If you have a Windows computer, you can also get these values through your computer.

 You can use ADSL modems that support DHCP if your network requires a Static IP address. ADSL modems that support DHCP also let you use Static IP addresses.

Network Setup (Auto)

Use the Automatic **Network Setup** when connecting your TV to a network that supports DHCP. To set up your TV's cable network connection automatically, follow these steps:

How to set up automatically

1. Connect your TV to your LAN as described in the previous section.
2. Turn on your TV, press the **MENU** button on your remote, use the **▲** or **▼** button to select **Setup**, and then press the **ENTER** button.
3. Use the **▲** or **▼** button to select **Network** in the **Setup** menu, and then press the **ENTER** button. The **Network** screen appears.

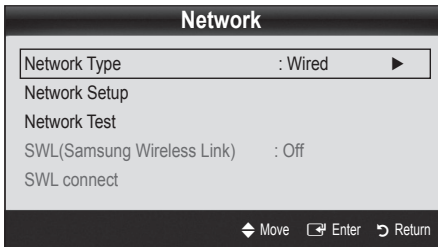

4. On the **Network** screen, select **Network Type**.
5. Set **Network Type** to **Wired**.
6. Select **Network Setup**. The **Network Setup** screen appears.

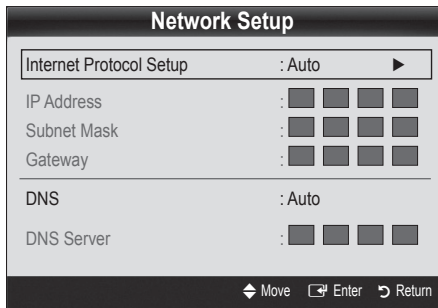

7. Set **Internet Protocol Setup** to **Auto**.
8. **Auto** acquires and enters the needed Internet values automatically.
9. Select **Network Test** to check the Internet connectivity.
10. If the **Network** Function has not acquired the network connection values, go to the directions for **Manual**.

Network Setup (Manual)

Use the Manual **Network Setup** when connecting your TV to a network that requires a Static IP address.

Getting the Network Connection Values

To get the Network connection values on most Windows computers, follow these steps:

1. Right click the Network icon on the bottom right of the screen.
2. In the pop-up menu that appears, click Status.
3. On the dialog that appears, click the Support tab.
4. On the Support Tab, click the Details button. The Network connection values are displayed.

How to set up manually

To set up your TV's cable network connection manually, follow these steps:

1. Follow Steps 1 through 6 in the "How to set up automatically" procedure.
2. Set **Internet Protocol Setup** to **Manual**.
3. Press the **▼** button on your remote to go to the first entry field.
4. Enter the **IP Address**, **Subnet Mask**, **Gateway**, and **DNS Server** values. Use the number buttons on your remote to enter numbers and the arrow buttons to move from one entry field to another.
5. When done, press the **RETURN** button on your remote.
6. Select **Network Test** to check the Internet connectivity.

Advanced Features

Connecting to a Wireless Network

To connect your TV to your network wirelessly, you need a wireless router or modem and a Samsung Wireless LAN Adaptor (WIS09ABGN), which you connect to your TV's back or side panel USB jack. See the illustration below.

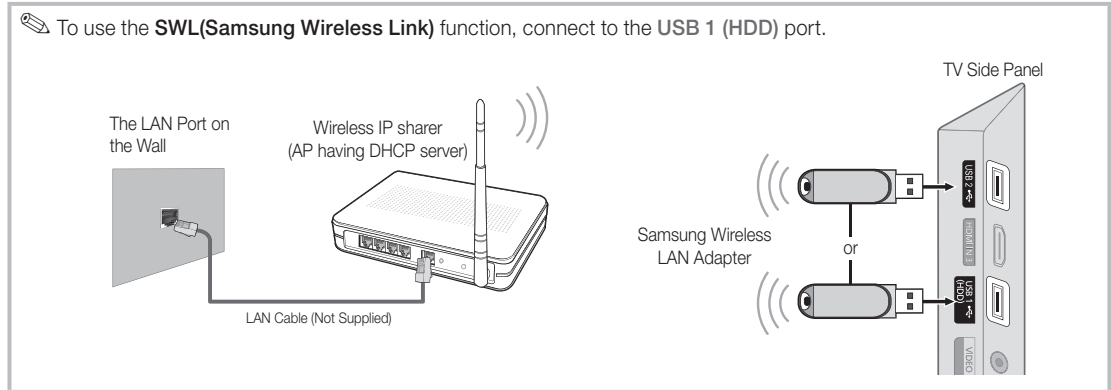



Samsung's Wireless LAN adaptor is sold separately and is offered by select retailers, Ecommerce sites and Samsungparts.com. Samsung's Wireless LAN adaptor supports the IEEE 802.11A/B/G and N communication protocols. Samsung recommends using IEEE 802.11N. When you play the video over a IEEE 802.11B/G connection, the video may not play smoothly.

NOTE





- You must use the “Samsung Wireless LAN Adapter” (WIS09ABGN) to use a wireless network.
- Samsung's Wireless LAN adaptor is sold separately. The WIS09ABGN Wireless LAN adaptor is offered by select retailers, Ecommerce sites and Samsungparts.com.
- To use a wireless network, your TV must be connected to a wireless IP sharer. If the wireless IP sharer supports DHCP, your TV can use a DHCP or static IP address to connect to the wireless network.
- Select a channel for the wireless IP sharer that is not currently being used. If the channel set for the wireless IP sharer is currently being used by another device nearby, this will result in interference and communication failure.
- If you apply a security system other than the systems listed below, it will not work with the TV.
- If Pure High-throughput (Greenfield) 802.11n mode is selected and the Encryption type is set to WEP, TKIP or TKIPAES (WPS2Mixed) for your AP, Samsung TVs will not support a connection in compliance with new Wi-Fi certification specifications.
- If your AP supports WPS (Wi-Fi Protected Setup), you can connect to the network via PBC (Push Button Configuration) or PIN (Personal Identification Number). WPS will automatically configure the SSID and WPA key in either mode.
- If your router, modem, or device isn't certified, it may not connect to the TV via the “Samsung Wireless LAN Adapter.”
- **Connection Methods:** You can setup the wireless network connection six ways.
 - Samsung Auto Configuration
 - **PBC (WPS)**
 - Auto Setup (Using the Auto Network Search function)
 - Manual Setup
 - **SWL(Samsung Wireless Link)**
 - **Ad-Hoc**
- All of Samsung Wireless LAN Adaptor should be connected directly to the TV's USB port. USB HUB are not supported.

Network Setup (Samsung Auto Configuration)

This function is available in APs (Access Points) that support Auto Configuration. If your AP does not, you can connect through **PBC (WPS)**, auto, or manually.

-  This function is available when **SWL(Samsung Wireless Link)** is set to **Off**.
-  You can check for equipment that supports Samsung Auto Configuration on www.samsung.com.



How to set up using Samsung Auto Configuration

1. Place the AP and TV next to each other and turn them on.
 -  Because the booting times of applications differ, you may have to wait for approximately 2 minutes.
 -  If the LAN cable connected the WAN port of AP during Samsung Auto Configuration, you are able to complete until internet connection test. If you do not connect, Samsung Auto configuration will check only device connecting of AP (Not check internet).
2. After 2 minutes, connect the Samsung Wireless LAN Adaptor to the TV. When the Samsung Wireless LAN Adaptor is established, the pop-up window appears.
3. As soon as a connection is established, place the AP in parallel with the Samsung Wireless LAN Adaptor giving a gap no larger than 25cm.
4. Wait until the connection is automatically established.
 -  If the connection fails, reset the AP and then try again.
 -  If Samsung Auto Configuration does not connect your TV to your AP, a pop-up window appears on the screen notifying you of the failure. Reset the AP, and then try again. If the connection fails again, choose one of the other connection setup methods, PBC (WPS), auto, or manual.
5. After the connection is established, locate the sharer at the desired location.
 -  If the AP settings have been changed or it is the first time you use the new AP after purchase, you need to set up again beginning from Step 1.

Network Setup (PBC (WPS))

How to set up using PBC (WPS)

If your router has a PBC (WPS) button, follow these steps:

1. Connect your TV to your LAN as described in the previous section.
2. Turn on your TV, press the **MENU** button on your remote, use the **▲** or **▼** button to select **Setup**, and then press the **ENTER**  button.
3. Use the **▲** or **▼** button to select **Network** in the **Setup** menu, and then press the **ENTER**  button.
4. On the **Network** screen, select **Network Type**.
5. Set **Network Type** to **Wireless**.
6. Select **Network Setup**. The **Network Setup** screen appears.

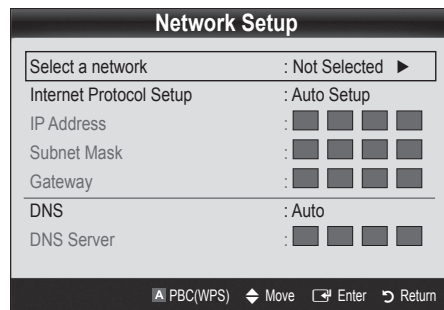

7. Press the Red button on your remote.
8. Press the PBC (WPS) button on your router within 2 minutes. Your TV player automatically acquires all the network setting values it needs and connects to your network.
9. After the network connection is set up, press the **RETURN** button to exit the **Network Setup** screen.

Network Setup (Auto)

Most wireless networks have an optional security system that requires devices that access the network to transmit an encrypted security code called an Access or Security Key. The Security Key is based on a Pass Phrase, typically a word or a series of letters and numbers of a specified length you were asked to enter when you set up security for your wireless network. If you use this method of setting up the network connection, and have a Security Key for your wireless network, you will have to enter the Pass Phrase during the setup process.

Advanced Features

How to set up automatically

To set up the wireless connection automatically, follow these steps:

1. Follow Steps 1 through 6 in the "How to set up using PBC (WPS)" (p. 29).
2. Press the ▼ button to select **Internet Protocol Setup**, and then press the ENTER button. Press the ▲ or ▼ button to select **Auto**, and then press the ENTER button.
3. Press the ▲ button to go to **Select a Network**, and then press the ENTER button. The **Network** function searches for available wireless networks. When done, it displays a list of the available networks.
4. In the list of networks, press the ▲ or ▼ button to select a network, and then press the ENTER button.
 - ✎ If the AP is set to Hidden (Invisible), you have to select **Add Network** and enter the correct **Network Name (SSID)** and **Security Key** to establish the connection.
5. If the Security/PIN pop-up appears, go to Step 6. If the Network Connecting Screen appears, go to Step 10.
6. Press the ▲ or ▼ button to select **Security** or **PIN**. For most home networks, you would select Security (for **Security Key**). The **Security** Screen appears.

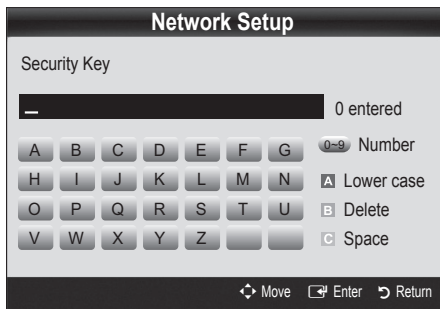

7. On the **Security** screen, enter your network's Pass Phrase.
 - ✎ You should be able to find the Pass Phrase on one of the set up screens you used to set up your router or modem.
8. To enter the Pass Phrase, follow these general directions:
 - Press the number buttons on your remote to enter numbers.
 - Use the direction buttons on your remote to move from button to button on the **Security Key** screen.
 - Press the Red button to change case or display symbols/characters.
 - To enter a letter or symbol, move to the letter or symbol, and then press the ENTER button.
 - To delete the last letter or number you entered, press the Green button on your remote.

9. When done, press the Blue button on your remote. The Network Connecting screen appears.
10. Wait until the connection confirmation message is displayed, and then press the ENTER button. The **Network Setup** screen re-appears.
11. To test the connection, press the RETURN button to select **Network Test**, and then press the ENTER button.

Ad-Hoc Network Setup

You can connect to a mobile device without an access point through the "Samsung Wireless LAN Adapter" by using a peer to peer network.

✎ This function is available when **SWL(Samsung Wireless Link)** is set to **Off**.

How to connect to a new Ad-hoc device

1. Follow Steps 1 through 6 in the "How to set up using PBC (WPS)" (p. 29).
2. Choose **Select a network**. A list of devices/networks appears.
3. While in the device list, press the Blue button on the remote.
 - ✎ The message **The existing network system may have limited functionality. Do you want to change the network connection?** is displayed.
4. Input the generated **Network Name (SSID)** and **Security Key** into the device you want to connect.

How to connect an existing Ad-hoc device

1. Follow Steps 1 through 6 in the "How to set up using PBC (WPS)" (p. 29).
2. Choose **Select a network**. The Device/Network list appears.
3. Select the device you want in the Device list.
4. If security key is required, input the security key.
 - ✎ If network doesn't operate normally, check the **Network Name (SSID)** and **Security Key** again. An incorrect **Security Key** may cause a malfunction.

Network Setup (Manual)

If the other methods do not work, you need to enter the Network setting values manually.

Getting the Network Connection Values

To get the Network connection values on most Windows computers, follow these steps:

1. Right click the Network icon on the bottom right of the screen.
2. In the pop-up menu, click Status.
3. On the dialog that appears, click the Support tab.
4. On the Support tab, click the Details button. The Network settings are displayed.



How to set up manually

To enter the Network connection values manually, follow these steps:

1. Follow Steps 1 through 6 in the “How to set up using PBC (WPS)” (p. 29).
2. Press the ▼ button to select **Internet Protocol Setup**, and then press the ENTER button. Press the ▲ or ▼ button to select **Manual**, and then press the ENTER button.
3. Press the ▼ button to go to the first entry field (IP Address).
4. Use the number buttons to enter numbers.
5. When done with each field, use the ► button to move successively to the next field. You can also use the other arrow buttons to move up, down, and back.
6. Enter the **IP Address**, **Subnet Mask**, and **Gateway** values.
7. Press the ▲ or ▼ button to go to **DNS**.
8. Press the ▼ button to go to the first DNS entry field. Enter the numbers as above.
9. When done, press the ▲ button to go to **Select a Network**. Select your network, and then press the ENTER button.
10. Go to Step 4 in the “How to set up automatically” (p. 30), and follow the directions from that point on.

SWL(Samsung Wireless Link)

This function lets you connect a Samsung device that supports the PBC (WPS) to your TV. You can connect devices to the TV even if a sharer is not connected to the TV.

-  To use the Internet@TV, the AP (access point) must be connected to the wireless network.
-  If a Samsung Wireless Lan Adaptor is connected to the **USB 2** port, the network may not operate normally. We recommend to connecting it to the **USB 1 (HDD)** port.
-  Only sharers using the 2.4 Ghz band are supported. Sharers using the 5 Ghz band are not supported.

SWL connect

You can directly connect a device that supports the PBC (WPS) to the TV.

-  This function is available when **SWL(Samsung Wireless Link)** is set to **On**.

How to connect Samsung Wireless Link

For the procedures to establish a connection, refer to the following:

1. Follow Steps 1 through 5 in the “How to set up using PBC (WPS)” (p. 29).
2. Select **Samsung Wireless Link** by using the ▼ button and press the ENTER button to turn it On.
3. Select **SWL connect** by using the ▼ button and press the ENTER button.
4. If the “**Press the PBC button on the device which supports PBC button to connect within 120 seconds**” message appears, press the PBC button on the device to connect.
 -  For more information, refer to the wireless network setup manual of the device to be connected.
5. If the device is connected properly to the TV after starting count on message box then message box will be disappeared automatically.
 -  If the connection fails, please retry after 2 minutes.

If Your TV Fails to Connect to the Internet

Your TV may not be able to connect to the Internet because your ISP has permanently registered the MAC address (a unique identifying number) of your PC or modem, which it then authenticates each time you connect to the Internet as a way of preventing unauthorized access. As your TV has a different MAC address, your ISP can not authenticate its MAC address, and your TV can not connect.

To resolve this problem, ask your ISP about the procedures required to connect devices other than a PC (such as your TV) to the Internet.

If your Internet service provider requires an ID or password to connect to the Internet, your TV may not be able to connect to the Internet. If this is the case, you must enter your ID or password when connecting to the Internet.



The internet connection may fail because of a firewall problem. If this is the case, contact your Internet service provider.

If you cannot connect to the Internet even after you have followed the procedures of your Internet service provider, please contact Samsung Electronics at 1-800-SAMSUNG.

Advanced Features

Media Play



 Enjoy photos, music and/or movie files saved on a USB Mass Storage Class (MSC) device.

 MENU  → Application → Content View → Media Play → ENTER 

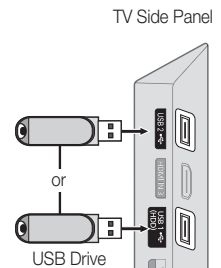

Connecting a USB Device

1. Turn on your TV.
2. Connect a USB device containing photo, music and/or movie files to the **USB 1 (HDD)** or **USB 2** jack on the side of the TV.
3. When USB is connected to the TV, popup window appears. Then you can select **Media Play**.



Connecting to your PC through a network

You can play pictures, music and videos saved on your PC on your TV through a network connection in the **Media Play** mode.

 If you want to use **Media Play** to play files saved on your PC over your TV, you should download "PC Share Manager" and users manual from "www.samsung.com."

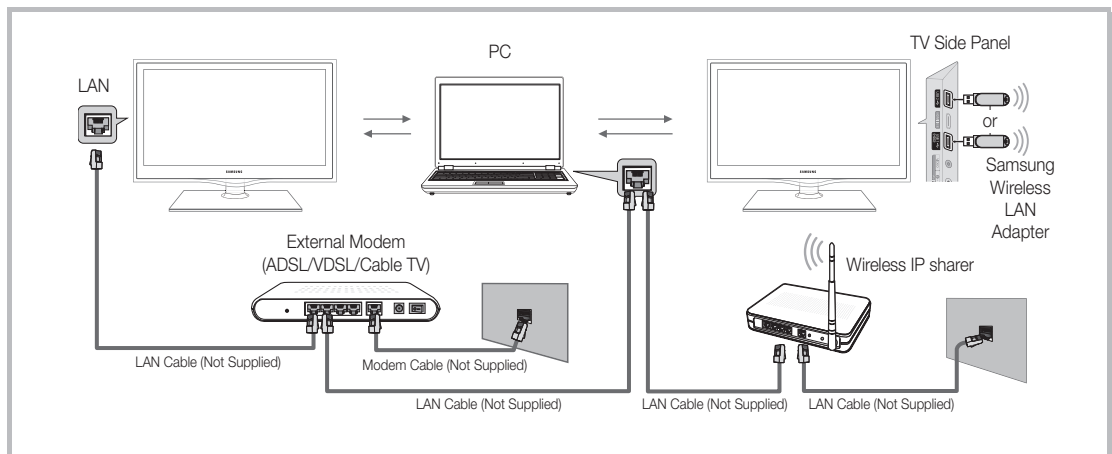



1. For more information on how to configure your network, refer to "Network Connection."
 - You are recommended to locate both the TV and the PC in same subnet. The first 3 parts of the subnet address of the TV and the PC IP addresses should be the same and only the last part (the host address) should be changed. (e.g. IP Address: 123.456.789.**)
2. Using a LAN cable, connect between the external modem and the PC onto which the Samsung PC Share Manager Program will be installed.
 - You can connect the TV to the PC directly without connecting it through a Sharer (Router).

- ✎ Functions that are not supported when connecting to a PC through a network:
 - The **Background Music** and **Background Music Setting** functions.
 - Sorting files by preference in the **Photos**, **Music**, and **Videos** folders.
 - The ⏮ (REW) or ⏭ (FF) button while a movie is playing.
- ✎ The Divx DRM, Multi-audio, embedded caption is not supported.
- ✎ Samsung PC Share manager should be permitted by the firewall program on your PC.
- ✎ When you use **Media Play** mode through a network connection, depending on the functions of the provided server:
 - The sorting method may vary.
 - The scene search function may not be supported.
 - The **Play Continuously** function, which resumes playing of a video, may not be supported.
 - The **Play Continuously** function does not support multiple users. (It will have only memorized the point where the most recent user stopped playing.)
 - The ⏮ (REW), ⏭ (FF) or ⏸ (Pause) buttons may not work depending on the content information.
 - If you experience any file stuttering issue while playing a video over a wireless network, we recommend using a wired network.
- ✎ It might not work properly with unlicensed multimedia files.
- ✎ Need-to-Know List before using **Media Play**
 - MTP (Media Transfer Protocol) is not supported.
 - The file system supports FAT16, FAT32 and NTFS.
 - Certain types of USB Digital camera and audio devices may not be compatible with this TV.
 - Media Play only supports USB Mass Storage Class (MSC) devices. MSC is a Mass Storage Class Bulk-Only Transport device. Examples of MSC are Thumb drives, Flash Card Readers and USB HDD (USB HUB are not supported). Devices should be connected directly to the TV's USB port.
 - Before connecting your device to the TV, please back up your files to prevent them from damage or loss of data. SAMSUNG is not responsible for any data file damage or data loss.
 - Connect a USB HDD to the dedicated port, **USB 1 (HDD)** port.
 - Do not disconnect the USB device while it is loading.
 - The higher the resolution of the image, the longer it takes to display on the screen.
 - The maximum supported JPEG resolution is 15360X8640 pixels.
 - For unsupported or corrupted files, the "Not Supported File Format" message is displayed.
 - If the files are sorted by Basic View, up to 1000 files can be displayed in each folder.
 - MP3 files with DRM that have been downloaded from a non-free site cannot be played. Digital Rights Management (DRM) is a technology that supports the creation, distribution and management of the content in an integrated and comprehensive way, including the protection of the rights and interests of the content providers, the prevention of the illegal copying of contents, as well as managing billings and settlements.
 - If more than 2 PTP devices are connected, you can only use one at a time.
 - If more than two MSC devices are connected, some of them may not be recognized. A USB device that requires high power (more than 500mA or 5V) may not be supported.
 - If an over-power warning message is displayed while you are connecting or using a USB device, the device may not be recognized or may malfunction.
 - If the TV has been no input during time set in **Auto Protection Time**, the Screensaver will run.
 - The power-saving mode of some external hard disk drives may be released automatically when connected to the TV.
 - If a USB extension cable is used, the USB device may not be recognized or the files on the device may not be read.
 - If a USB device connected to the TV is not recognized, the list of files on the device is corrupted or a file in the list is not played, connect the USB device to the PC, format the device and check the connection.
 - If a file deleted from the PC is still found when Media Play is run, use the "Empty the Recycle Bin" function on the PC to permanently delete the file.

Advanced Features

Screen Display

Move to the desired file using the up/down/right/left buttons and then press the ENTER  or  (Play) button. The file is played.

 Supports the **View Devices** and **Home** in **Media Play** homepage.

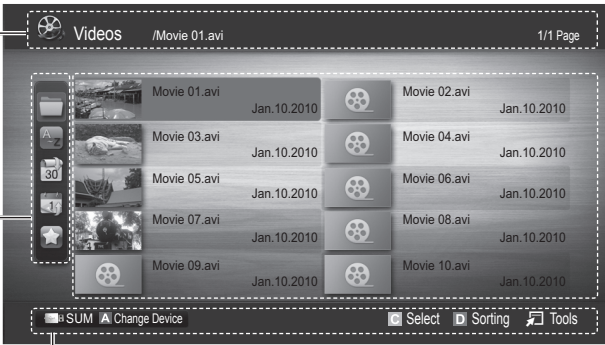









Information:
You can ascertain the selected file name and the number of files and page.

Sort List Section:
Displays the sorting standard.

File List Section:
You can confirm the files and groups that are sorted by category.











Operation Buttons

-  **Red (Change Device):** Selects a connected device.
-  **Green (Preference):** Sets the file preference. (not supported in Basic view)
-  **Yellow (Select):** Selects multiple files from file list. Selected files are marked with a symbol.
-  **Blue (Sorting):** Selects the sort list.
-  **Tools:** Displays the option menu.

 Using the  or  button, file list can move to next or previous page.

Videos

Playing Video

1. Press the  or  button to select **Videos**, then press the ENTER  button in the **Media Play** menu.
2. Press the /// button to select the desired video in the file list.
3. Press the ENTER  button or  (Play) button.
 - The selected file is displayed on the top with its playing time.
 - If video time information is unknown, play time and progress bar are not displayed.
 - During video playback, you can search using the  and  button.

 In this mode, you can enjoy movie clips contained on a Game, but you cannot play the Game itself.

- Supported Subtitle Formats

Name	File extension	Format
MPEG-4 time-based text	.txt	XML
SAMI	.smi	HTML
SubRip	.srt	string-based
SubViewer	.sub	string-based
Micro DVD	.sub or .txt	string-based

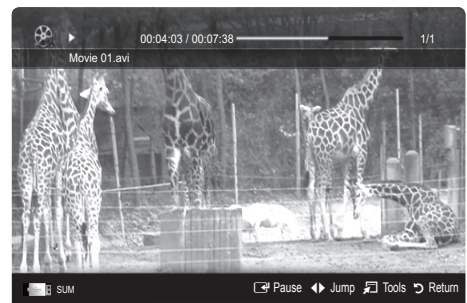

- Supported Video Formats

File Extension	Container	Video Codec	Resolution	Frame rate (fps)	Bit rate (Mbps)	Audio Codec
*.avi *.mkv	AVI MKV	Divx 3.11 / 4.x / 5.1 / 6.0	1920x1080	6 ~ 30	8	MP3 / AC3 / LPCM / ADPCM / DTS Core
		XviD	1920x1080	6 ~ 30	8	
		H.264 BP / MP / HP	1920x1080	6 ~ 30	25	
		MPEG4 SP / ASP	1920x1080	6 ~ 30	8	
		Motion JPEG	800x600	6 ~ 30	8	
*.asf	ASF	Divx 3.11 / 4.x / 5.1 / 6.0	1920x1080	6 ~ 30	8	MP3 / AC3 / LPCM / ADPCM / WMA
		XviD	1920x1080	6 ~ 30	8	
		H.264 BP / MP / HP	1920x1080	6 ~ 30	25	
		MPEG4 SP / ASP	1920x1080	6 ~ 30	8	
		Motion JPEG	800x600	6 ~ 30	8	
*.wmv	ASF	Window Media Video v9	1920x1080	6 ~ 30	25	WMA
*.mp4	MP4	H.264 BP / MP / HP	1920x1080	6 ~ 30	25	MP3 / ADPCM / AAC
		MPEG4 SP / ASP	1920x1080	6 ~ 30	8	
		XVID	1920x1080	6 ~ 30	8	
*.3gp	3GPP	H.264 BP / MP / HP	1920x1080	6 ~ 30	25	ADPCM / AAC / HE-AAC
		MPEG4 SP / ASP	1920x1080	6 ~ 30	8	
*.vro *.vob	VRO VOB	MPEG1	1920x1080	24 / 25 / 30	30	AC3 / MPEG / LPCM
		MPEG2	1920x1080	24 / 25 / 30	30	
*.mpg *.mpeg	PS	MPEG1	1920x1080	24 / 25 / 30	30	AC3 / MPEG / LPCM / AAC
		MPEG2	1920x1080	24 / 25 / 30	30	
		H.264	1920x1080	6 ~ 30	25	
*.ts *.tp *.trp	TS	MPEG2	1920x1080	24 / 25 / 30	30	AC3 / AAC / MP3 / DD+ / HE-AAC
		H.264	1920x1080	6 ~ 30	25	
		VC1	1920x1080	6 ~ 30	25	

Other Restrictions

NOTE

- If there are problems with the contents of a codec, the codec will not be supported.
- If the information for a Container is incorrect and the file is in error, the Container will not be able to play correctly.
- Sound or video may not work if the contents have a standard bitrate/frame rate above the compatible Frame/sec listed in the table above.
- If the Index Table is in error, the Seek (Jump) function is not supported.



Video Decoder	Audio Decoder
<ul style="list-style-type: none"> Supports up to H.264, Level 4.1 H.264 FMO / ASO / RS, VC1 SP / MP / AP L4 and AVCHD are not supported. XVID, MPEG4 SP, ASP : <ul style="list-style-type: none"> Below 1280 x 720: 60 frame max Above 1280 x 720: 30 frame max GMC 2 over is not supported. Only Samsung Techwin MJPEG is supported. H.263 is not supported. 	<ul style="list-style-type: none"> Supports up to WMA 7, 8, 9, STD WMA 9 PRO does not support 2 channel excess multi channel or lossless audio. WMA sampling rate 22050Hz mono is not supported.

Advanced Features

Playing movie continuously (Resume Play)

If you exit the playing movie function, the movie can be played later from the point where it was stopped.

 If you press the **ENTER** button (**Chaptering**) during playing the file, you can explore scene divided into 5 chapters you want.

1. Select the movie file you want to play continuously by pressing the ◀ or ▶ button to select it from the file list section.
2. Press the ▶ (Play) / **ENTER** button.
3. Select **Play Continuously** (Resume Play) by pressing the Blue button. The Movie will begin to play from where it was stopped.
 -  The Blue button is available when resuming play.
 -  If the **Continuous Movie Play Help** function is set to **On** in the **Settings** menu, a pop-up message will appear when you resume play a movie file.



Music

Playing Music

1. Press the ◀ or ▶ button to select **Music**, then press the **ENTER** button in the **Media Play** menu.
2. Press the ◀/▶/▲/▼ button to select the desired Music file in the file list.
3. Press the **ENTER** button or ▶ (Play) button.
 - During music playback, you can search using the ◀ and ▶ buttons.
 - ◀ (REW) and ▶ (FF) buttons do not function during play.

 Only displays the files with MP3 and PCM file extension. Other file extensions are not displayed, even if they are saved on the same USB device.

 If the sound is abnormal when playing MP3 files, adjust the **Equalizer** in the **Sound** menu. (An over-modulated MP3 file may cause a sound problem.)

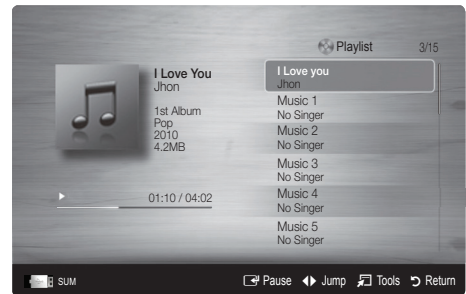

Creating My Playlist

1. Press the ◀/▶/▲/▼ button to select the tracks you want to add and press the **TOOLS** button.
2. Select **Add My Playlist**.
3. When the **Add My Playlist** menu appears, select **New My Playlist**.

 To add to an old play list, simply select the play list you want to add music to.



4. The newly created or updated playlist will be in the main **Music** page.

Playing My Playlist

Select the **My Playlist** folder and it will play automatically. Press the ▲ or ▼ button to select a different music file within the play list.

Photos

Viewing a Photo (or Slide Show)

1. Press the ◀ or ▶ button to select **Photos**, then press the ENTER  button in the **Media Play** menu.
2. Press the ◀/▶/▲/▼ button to select the desired photo in the file list.
3. Press the ENTER  button or ▶ (Play) button.
 - While a photo list is displayed, press the ▶ (Play) / ENTER  button on the remote control to start the slide show.
 - All files in the file list section will be displayed in the slide show.
 - During the slide show, files are displayed in order.

 Music files can be automatically played during the Slide Show if the **Background Music** is set to **On**.

 The **BGM Mode** cannot be changed until the BGM has finished loading.



Playing Multiple Files

Playing selected video/music/photo files

1. Press the Yellow button in the file list to select the desired file.
2. Repeat the above operation to select multiple files.

NOTE

- The ✓ mark appears to the left of the selected files.
- To cancel a selection, press the Yellow button again.
- To deselect all selected files, press the **TOOLS** button and select **Deselect All**.

3. Press the **TOOLS** button and select **Play Selected Contents**.

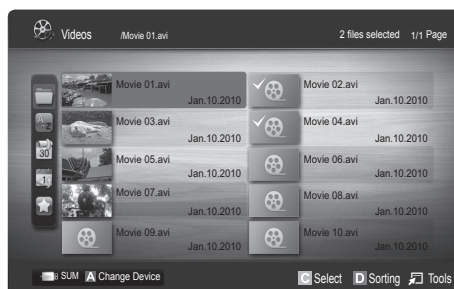











Playing the video/music/photo file group

1. While a file list is displayed, move to any file in the desired group.
2. Press the **TOOLS** button and select **Play Current Group**.

Media Play - Additional Functions

Sorting the file list

Press the Blue button in the file list to sort the files.

Category	Operation	Videos	Music	Photos
 Basic View	Displays the whole folder. You can view the photo by selecting the folder.	▼	▼	▼
 Title	Sorts and displays the file title in Symbol/Number/Alphabet/Special order.	▼	▼	▼
 Preference	Sorts and displays the file by preference. You can change the file preference in the file list section using the Green button.	▼	▼	▼
 Latest Date	Sorts and shows files by the latest date.	▼		▼
 Earliest Date	Sorts and shows files by the earliest date.	▼		▼
 Artist	Sorts the music file by artist in alphabetical order.		▼	
 Album	Sorts the music file by album in alphabetical order.		▼	
 Genre	Sorts music files by the genre.		▼	
 Mood	Sorts music files by the mood. You can change the music mood information.		▼	
 Monthly	Sorts and shows photo files by month.			▼

Advanced Features

Videos/Music/Photos Play Option menu

During file playback, press the **TOOLS** button.

Category	Operation	Videos	Music	Photos
Title	You can move directly to another Title.	▼		
Repeat Mode	You can play movie and music files repeatedly.	▼	▼	
Picture Size (Mode1 / Mode2 / Original)	You can adjust the picture size to your preference.	▼		
Picture Setting	You can adjust the picture setting. (p. 16, 17, 18, 19)	▼		▼
Sound Setting	You can adjust the sound setting. (p. 19, 20)	▼	▼	▼
Subtitle Setting	You can play the video with Subtitles. This function only works if the subtitles are the same file name as the video.	▼		
Audio	You can enjoy video in one of supported languages as required. The function is only enabled when stream-type files which support multiple audio formats are played.	▼		
Stop Slide Show / Start Slide Show	You can start or stop a Slide Show.			▼
Slide Show Speed	You can select the slide show speed during the slide show.			▼
Slide Show Effect	You can set various slide show effects.			▼
Background Music	You can set and select background music when watching a Slide Show.			▼
Zoom	You can zoom into images in full screen mode.			▼
Rotate	You can rotate images in full screen mode.			▼
Home Background	You can move the file to the Media Play desktop.			▼
Information	You can see detailed information about the played file.	▼	▼	▼

Settings

Using the Setup Menu

- **Background Setting:** Select to display the background you want.
- **Continuous Movie Play Help (Resume Play) (On / Off):** Select to display the help pop-up message for continuous movie playback.
- **Get DivX® VOD registration code:** Shows the registration code authorized for the TV. If you connect to the DivX web site and register, you can download the VOD registration file. If you play the VOD registration using Media Play, the registration is completed.
 For more information on DivX® VOD, visit "www.DivX.com."
- **Get DivX® VOD deactivation code:** When DivX® VOD is not registered, the registration deactivation code is displayed. If you execute this function when DivX® VOD is registered, the current DivX® VOD registration is deactivated.
- **Information:** Select to view information about the connected device.

What is Anynet+? TOOLS

Anynet+ is a function that enables you to control all connected Samsung devices that support Anynet+ with your Samsung TV's remote. The Anynet+ system can be used only with Samsung devices that have the Anynet+ feature. To be sure your Samsung device has this feature, check if there is an Anynet+ logo on it.

To connect to a Samsung Home Theater

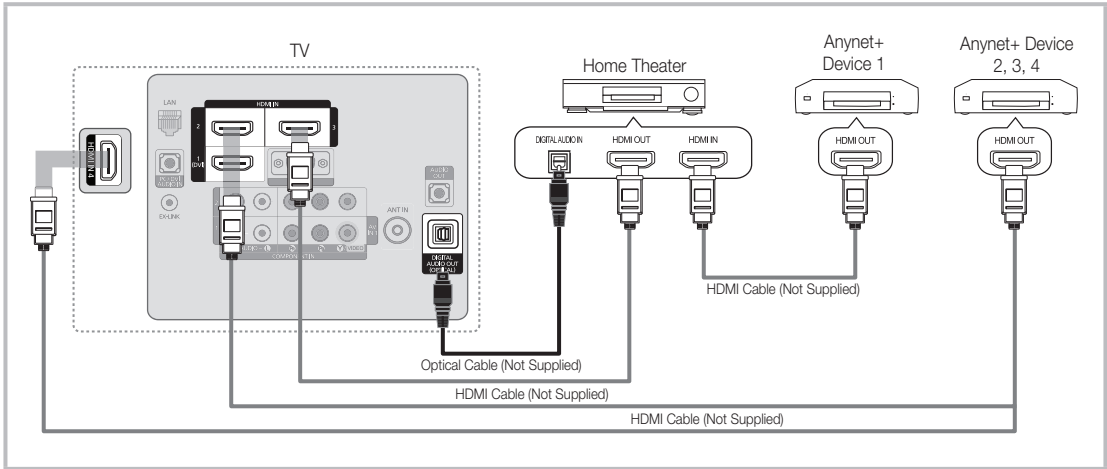

1. Connect the **HDMI IN (1(DVI), 2, 3 or 4)** jack on the TV and the **HDMI OUT** jack of the corresponding Anynet+ device using an HDMI cable.
2. Connect the **HDMI IN** jack of the home theater and the **HDMI OUT** jack of the corresponding Anynet+ device using an HDMI cable.

NOTE

- Connect the Optical cable between the **DIGITAL AUDIO OUT (OPTICAL)** jack on your TV and the Digital Audio Input on the Home Theater.
- When following the connection above, the Optical jack only outputs 2 channel audio. You will only hear sound from the Home Theater's Front, Left and Right speakers and the subwoofer. If you want to hear 5.1 channel audio, connect the **DIGITAL AUDIO OUT (OPTICAL)** jack on the DVD / Satellite Box (i.e. Anynet Device 1 or 2) directly to the Amplifier or Home Theater, not the TV.
- You can connect only one Home Theater.
- You can connect an Anynet+ device using the HDMI cable. Some HDMI cables may not support Anynet+ functions.
- Anynet+ works when the AV device supporting Anynet+ is in the standby or on status.
- Anynet+ supports up to 12 AV devices in total. Note that you can connect up to 3 devices of the same type.

Advanced Features

Anynet+ Menu

The Anynet+ menu changes depending on the type and status of the Anynet+ devices connected to the TV.

Anynet+ Menu	Description
View TV	Changes Anynet+ mode to TV broadcast mode.
Device List	Shows the Anynet+ device list.
(device_name) MENU	Shows the connected device menus. E.g. If a DVD recorder is connected, the disc menu of the DVD recorder will appear.
(device_name) INFO	Shows the play menu of the connected device. E.g. If a DVD recorder is connected, the play menu of the DVD recorder will appear.
Recording: (*recorder)	Starts recording immediately using the recorder. (This is only available for devices that support the recording function.)
Stop Recording: (*recorder)	Stops recording.
Receiver	Sound is played through the receiver.

If more than one recording device is connected, they are displayed as (*recorder) and if only one recording device is connected, it will be represented as (*device_name).

Setting Up Anynet+

 MENU  → **Application** → **Anynet+ (HDMI-CEC)** → ENTER 

Setup

Anynet+ (HDMI-CEC) (Off / On): To use the Anynet+ Function, **Anynet+ (HDMI-CEC)** must be set to **On**.



 When the **Anynet+ (HDMI-CEC)** function is disabled, all the Anynet+ related operations are deactivated.

Auto Turn Off (No / Yes): Setting an Anynet+ Device to turn off automatically when the TV is turned off.

 The active source on the TV must be set to TV to use the Anynet+ function.







 Even if an external device is still recording, it may turn off.

Switching between Anynet+ Devices

1. Anynet+ devices connected to the TV are listed.
 -  If you cannot find a device you want, press the Red button to refresh the list.
2. Select a device and press the ENTER  button. You can switch to the selected device.
 -  Only when you set **Anynet+ (HDMI-CEC)** to **On** in the **Application** menu, the **Device List** menu appears.
 - Switching to the selected device may take up to 2 minutes. You cannot cancel the operation during the switching operation.
 - If you have selected external input mode by pressing the **SOURCE** button, you cannot use the Anynet+ function. Make sure to switch to an Anynet+ device by using the **Device List**.

Recording

You can make a recording of a TV Program using a Samsung recorder.



1. Select **Recording**.
 -  When there are more than two recording devices
 - When multiple recording devices are connected, the recording devices are listed. Select one recording device in the **Device List**.
 -  When the recording device is not displayed, select **Device List** and press the Red button to search devices.
2. Press the EXIT button to exit.
 -  You can record the source streams by selecting **Recording:** (device_name).
 -  Pressing the  (REC) button will record whatever you are currently watching. If you are watching video from another device, the video from the device is recorded.
 -  Before recording, check whether the antenna jack is properly connected to the recording device. To properly connect an antenna to a recording device, refer to the recording device's users manual.

Listening through a Receiver

You can listen to sound through a receiver (i.e Home Theater) instead of the **TV Speaker**.

1. Select **Receiver** and set to **On**.

2. Press the **EXIT** button to exit.

-  If your receiver supports audio only, it may not appear in the device list.
-  The receiver will work when you have properly connected the optical in jack of the receiver to the **DIGITAL AUDIO OUT (OPTICAL)** jack of the TV.
-  When the receiver (i.e Home Theater) is set to On, you can hear sound output from the TV's Optical jack. When the TV is displaying a DTV (air) signal, the TV will send out 5.1 channel sound to the receiver. When the source is a digital component such as a DVD and is connected to the TV via HDMI, only 2 channel sound will be heard from the receiver.

NOTE

- You can only control Anynet+ devices using the TV remote control, not the buttons on the TV.
- The TV remote control may not work under certain conditions. If this occurs, reselect the Anynet+ device.
- The Anynet+ functions do not operate with other manufacturers' products.

Troubleshooting for Anynet+

Problem	Possible Solution
Anynet+ does not work.	<ul style="list-style-type: none"> • Check if the device is an Anynet+ device. The Anynet+ system supports Anynet+ devices only. • Only one receiver (home theater) can be connected. • Check if the Anynet+ device power cord is properly connected. • Check the Anynet+ device's Video/Audio/HDMI cable connections. • Check whether Anynet+ (HDMI-CEC) is set to On in the Anynet+ setup menu. • Check whether the TV remote control is in TV mode. • Check whether the remote control is Anynet+ compatible. • Anynet+ doesn't work in certain situations. (Searching channels, operating Media Play or Plug & Play (initial setup), etc.) • When connecting or removing the HDMI cable, please make sure to search devices again or turn your TV off and on again. • Check if the Anynet+ Function of Anynet+ device is set on.
I want to start Anynet+.	<ul style="list-style-type: none"> • Check if the Anynet+ device is properly connected to the TV and check if the Anynet+ (HDMI-CEC) is set to On in the Anynet+ Setup menu. • Press the TOOLS button to display the Anynet+ menu and select a menu you want.
I want to exit Anynet+.	<ul style="list-style-type: none"> • Select View TV in the Anynet+ menu. • Press the SOURCE button on the TV remote control and select a non- Anynet+ device. • Press ▼ CH ▲, PRE-CH, and FAV.CH to change the TV mode. (Note that the channel button operates only when a tuner-embedded Anynet+ device is not connected.)
The message "Connecting to Anynet+ device..." appears on the screen.	<ul style="list-style-type: none"> • You cannot use the remote control when you are configuring Anynet+ or switching to a view mode. • Use the remote control when the Anynet+ setting or switching to view mode is complete.
The Anynet+ device does not play.	<ul style="list-style-type: none"> • You cannot use the play function when Plug & Play (initial setup) is in progress.
The connected device is not displayed.	<ul style="list-style-type: none"> • Check whether or not the device supports Anynet+ functions. • Check whether or not the HDMI cable is properly connected. • Check whether Anynet+ (HDMI-CEC) is set to On in the Anynet+ setup menu. • Search Anynet+ devices again. • You can connect an Anynet+ device using the HDMI cable only. Some HDMI cables may not support Anynet+ functions. • If connection is terminated because there has been a power interruption or the HDMI cable has been disconnected, please repeat the device scan.
The TV Program cannot be recorded.	<ul style="list-style-type: none"> • Check whether the antenna jack on the recording device is properly connected.
The TV sound is not output through the receiver.	<ul style="list-style-type: none"> • Connect the optical cable between TV and the receiver.

Advanced Features

Internet@TV

Getting Started with Internet@TV



Internet@TV brings useful and entertaining contents and services directly from the web to your TV.

MENU → Application → Content View → Internet@TV → ENTER



NOTE

- Configure the network settings before using **Internet@TV**. For more information, refer to “Network Connection” (p. 26).
- Unsupported fonts within the provider’s content will not display normally.
- Slow responses and/or interruptions may occur, depending on your network conditions.
- Depending on the region, English may be the only language supported for widget services.
- This feature is not available in some locations.
- If you experience a problem using a application, please contact the content provider.
- According to circumstances of the contents provider, an application’s updates or the application itself may be discontinued.
- Depending on your country’s regulations, some applications may have limited service or not be supported.

Screen Display

TV Screen:
Displays the current channel.

Information:
Displays notices, new applications, and advertisements brought to you by Samsung product introductions.

Application service:
You can experience various service by provided samsung.

Recommended Applications:
Displays the recommended service by Samsung. You are not able to add or delete a service in this list.

Downloaded Applications:
Displays the downloaded applications through the Samsung Apps.

Internet@TV Settings:
Edit and configure applications and Internet@TV settings.

Controls:

- **Red (Login):** To log in to to Internet@TV.
- **Green (Mark as Favorite):** To mark the Applications as a favorite.
- **Blue (Sort by):** To sort the applications.
- **Return:** To return to the previous menu.

The color buttons may work differently depending on the application.

Account Login

For a application with multiple accounts, use ◀ and ▶ to access the different account.

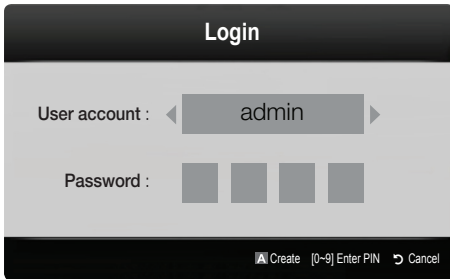

- ✎ For a more enjoyable application experience, register and log in to your account.
- ✎ For instructions on creating an account, refer to **Settings → Internet@TV ID → Create**.
- 1. Press the Red button in the **Internet@TV** home page.
- 2. Select desired **User account**, then press the ENTER button.
 - ✎ If you want to create an account, press the Red button; then create account OSD window appear.
- 3. After selecting **User account**, then enter the **Password** using the number button on the remote controller.
 - ✎ When login succeeds, User account will be displayed on the screen.

Setting up Internet@TV

Settings

Create IDs and configure Internet@TV settings from this screen. Highlight Settings using the ▲ and ▼ buttons and press the ENTER button.

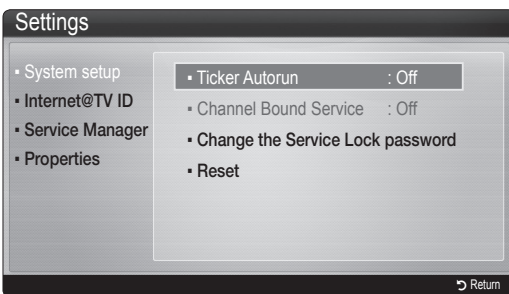

System Setup

Ticker Autorun (Off / On): Enable/disable **Ticker Autorun** upon powering on the TV.

✎ The **Ticker** application provides useful News, Weather, and Stock Market information. The **Ticker** application on **Internet@TV** must be downloaded to use this feature.

✎ Depending on your country, the **Ticker** application may have different service or not be supported.

Channel Bound Service (Off / On): Some channels support applications as an Internet data service, allowing you to access the Internet service while watching TV.

✎ Only available if supported by the broadcaster.

Reset: Resets Internet@TV settings to factory default settings.

Change the Service Lock password

✎ The default password set is "0-0-0-0."

✎ If you forget the password you created, press the following sequence of remote control buttons to reset the password to "0-0-0-0": **POWER (off) → MUTE → 8 → 2 → 4 → POWER (on)**.

Internet@TV ID

You can use this menu when creating and deleting the account. You can control your account including contents site's account information.

✎ Account is only for internet@TV.

Create: Create an account and link it with desired service applications.



NOTE

- Maximum number of accounts is 10.
- Maximum number of characters is 8.

Advanced Features

How to create Internet@TV ID

Before create **User account**, you should download the application first on the **Samsung Apps**.

1. Using the ▲/▼/◀/▶ button, select Settings. Then press the ENTER  button.
2. Press the ▼ button to select **Internet@TV ID**, then press the ENTER  or ▶ button.
3. Select **Create**. The Keypad screen will appear.
4. The keypad OSD will be displayed on the screen.





Using the Keypad

Pressing the – button on the remote while you are using the Screen Keypad enables you to change the text fields to lower case, upper case, numbers and icons.

You can use this Screen Keypad in several Internet@TV applications.

Here is how to input characters.

- 4-1. For example, suppose that you want to input “105Chang”.
- 4-2. Press the – button on the remote twice to change the input mode from lower case to numbers.
- 4-3. Press the 1, 0 and 5 button in numerical order.
- 4-4. Press the – button on the remote 3 times to change the input mode from numbers to upper case.
- 4-5. Press the 2 button on the remote 3 times to input **C**.
- 4-6. Press the – button on the remote 3 times to change the input mode from upper case to lower case.
- 4-7. Press buttons on the remote to input the rest of “Chang”. When done, press the ENTER  button.

5. Using the number buttons, enter the **User account** and **Password**.
 - Password must be numbers only.
 - Using the - button, you can change the text fields to lower case, upper case, numbers and icons.
 - You can delete the entered character using the PRE-CH button.
 - Using the ◀◀ (REW) or ▶▶ (FF) button, you can select icon you want to enter in icon keypad screen.
6. Account created. The provided services can be accessed by all users of your Samsung TV with a single login by linking the users' account to the TV ID. If you want to register a service site ID, select **Yes**. **Service Site** list will appear on the screen.
7. Select **Register** of the **Service Site** you want, then press the ENTER  button.
8. Using number buttons, enter your application site ID and password. Then press the ENTER  button.
9. Registered successfully. If you add another service site, select **Yes**. then press the ENTER  button, go to step 5.
10. When completed, select **OK**. Then press the ENTER  button.

Manager

- **Service Site**: Register login information for service sites.
- **Change Password**: Change account password.
- **Delete**: Delete the account.

- **Service Manager**: Delete and lock applications installed to Internet@TV.

Lock: Lock the application.

 Accessing a locked application requires the password.

Delete: Delete the application.

- **Properties**: Display information about Internet@TV. Use the **Check the speed of your internet connection** option to test your network connection.

Using the Internet@TV service

Samsung Apps

Samsung Apps is a store for downloading applications to be used on Samsung TV/AV equipment.

Users can enjoy a variety of contents like videos, music, photos, games, useful information etc. using the downloaded applications.

Additional applications will be available in the future.

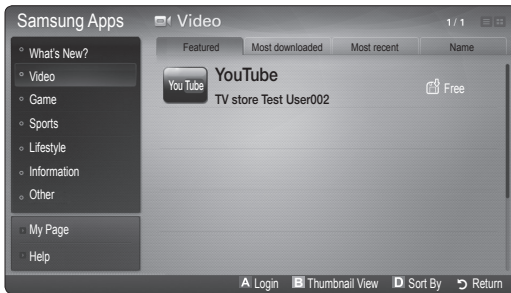

Using the color buttons with the **Samsung Apps**.

- **Red (Login):** To log in to the internet service.
- **Green (Thumbnail View):** To change the view mode.
- **Blue (Sort By):** To sort the applications by **Featured, Most downloaded, Most recent** or **Name**.
- **Return:** Moves to previous menu.

Using the Samsung Apps by category

The following categories are available:

- **What's New?:** Displays newly registered applications.
- **Video:** Displays various video media such as movies, TV shows and short length videos.
- **Game:** Displays various games such as sudoku and chess.
- **Sports:** Displays various sports media such as match information, images and short length video.
- **Lifestyle:** Includes various lifestyle media services such as music, personal photo management tools and social networking such as Facebook and Twitter.
- **Information:** Includes various information services such as news, stocks and weather.
- **Other:** Includes other miscellaneous services.
- **My Page:** Displays the application list and your cyber cash balance.
 - Starting in the middle of 2010 (US and Korea only), you can purchase cyber-cash for buying applications through tv.samsung.com.
- **Help:** If you have questions about Internet@TV, check this section first.

Advanced Features

Yahoo



Internet@TV provides an integrated Internet and television experience powered by the Yahoo!® Widget Engine. You can monitor financial stocks, share photos with friends and family, and track news and weather all through the Yahoo!® Widget Engine.

- When running Internet@TV for the first time, you will be prompted to configure the basic settings.
- Depending on your country's regulations, some applications may have limited service or not be supported.

Screen Display

- Dock Mode



Welcome Banner: Shows your profile.

- Blue (**Viewport**): Toggles between Viewport and Overlay modes.
- Yellow (**Edit Snippet**): To edit snippets with a help window.
 - In Viewport mode, the TV or video plays in a scaled-down area with graphics outside. In overlay mode, the graphics are displayed on top of the TV or video.

Dock: Displays your snippets.

- Snippets are quick launch icons for your widgets.
- PROFILE** Widget and **Widget Gallery** cannot be deleted.

- Sidebar Mode



Widget logo and Current menu.

Contents List :
The current selection is highlighted in blue.
Displays the current page and number of total pages.

Controls:

- Red: To close the widget. If you want to see the Dock mode, press the YAHOO! button.
- Green: To change the widget's settings.
- Yellow: To manage your snippets.
- Blue: To size video to fit or display in full screen.

Some buttons may not be available with certain widgets.

Editing Snippets in the Dock

1. Edit a snippet by selecting in the dock and pressing the Yellow button.
2. The snippet moves to the Second position and its tile slides up to show the following help text:



Using the color buttons with the dock mode.

- Red (**Delete**): To remove the widget.
 - Deleted widgets can be restored from **Widget Gallery**.
- Blue (**Move**): To rearrange snippets.
- Yellow (**Done**): To exit the **Edit Snippet** menu.

PROFILE Widget

Set up user profiles through Profile Widget. You can set up multiple profiles, each with its own list of widgets. Use the **Switch Profile** option to switch to a different user profile.

 There must be at least two registered profiles. For instructions on adding a profile, refer to **Administrative Controls**.

- Use the **Profile Settings** option to customize and protect your profile.
 - User profiles can be customized with a unique name and avatar (a picture used to represent your profile).
 - Your profile's name and avatar are displayed in the profile snippet in the dock.
 - Protect your profile using the **Create Profile PIN** option.
 - When setting up a new PIN, you can set a **Security Question**.
- The **Profile Settings** option limits access to the profile's widgets.
 - If you forget your Profile PIN, answer your profile's **Security Question**.
 - New widgets cannot be added to profiles with **Limit Profile** indicator enabled.
 -  Owner PIN must be set to use this feature. For instructions on setting Owner PIN, refer to **Administrative Controls**.
- **System Settings** allows you to:
 - Change your **Location** and **Zip Code** (US only) to tailor contents specific to your region.
 - Replay the tutorial that was shown during guided setup.
 - **Restore Factory Settings** resets all widget settings and information.
 -  When you cannot run **Restore Factory Settings** normally or you can not install/run the specific widgets normally, press the remote control buttons in the following sequence, which resets the Yahoo Service: **POWER** (on) → **MUTE** → 9 → 4 → 8 → **EXIT** → **POWER** (off) → **POWER** (on) → **YAHOO!** (If Yahoo Service is displayed on TV Screen, You should stop the Yahoo Service using **EXIT** button in advance).

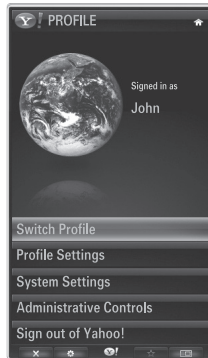

- From the **Administrative Controls** menu you can:
 - Configure Screen Saver timeout to avoid screen burn-in.
 - **Create Owner PIN** and set a **Security Question** to control other profiles.
 - Create and configure a new profile with a unique set of widgets.
 - Delete an existing profile.
- Sign into Yahoo!® from **PROFILE** Widget using your **Yahoo! ID**.
 - If you have a **Yahoo! ID**, you can access personalized content using Yahoo! TV widgets.
 - You will be automatically signed-in to all installed Yahoo! TV widgets with your profile's **Yahoo! ID**.
 - If you do not have a Yahoo! account, visit "www.yahoo.com" to create one.
 - You may not be able to log in with an ID created through a Yahoo website in a country that does not support Internet@TV.
- About Profile Widget: Press the Green button to view a brief description of Profile Widget, Copyright Policy, Terms of Service, and Privacy Policy.

Widget Gallery

Use Yahoo!® Widget Gallery to add more widgets to your TV. View available TV widgets in the following categories:

- **Featured:** Displays recommended widgets.
- **Latest:** Displays the most recent widgets.
- **All widgets:** Displays all widgets.
- **Categories:** Displays all widgets by category.

 To install a widget, navigate to the detail screen and select **Add Widget to My Profile** and press ENTER [↵]. The widget will be installed and become available in the dock.



- **Widget Gallery Settings:** Press the Green button.
 - **About Yahoo! Widget Gallery...:** You can view brief information for the Widget Gallery, Copyright Policy, Terms of Service, and Privacy Policy.
 - **TV Widget Software:** Displays the current version of the system software, and installed widgets.
 - Create your own widgets through the **Developer Settings** menu. For more information, visit our developer site at <http://connectedtv.yahoo.com/>.

Advanced Features

Troubleshooting for internet@TV

Problem	Possible Solution
Some application contents only have English. How can I change the language?	The Application content language may be different from the application user interface language. It depends on service provider.
Some application services do not work.	Check with the service provider. Refer to the help website for application service provider information.
When a network error occurred, I can't use other menus except setting menu.	If network connection doesn't work, your service might be limited, as all functions except the setting menu are needed to connect to the internet.

All content and services accessible through this device belong to third parties and are protected by copyright, patent, trademark and/or other intellectual property laws. Such content and services are provided solely for your personal noncommercial use. You may not use any content or services in a manner that has not been authorized by the content owner or service provider. Without limiting the foregoing, unless expressly authorized by the applicable content owner or service provider, you may not modify, copy, republish, upload, post, transmit, translate, sell, create derivative works, exploit, or distribute in any manner or medium any content or services displayed through this device.

YOU EXPRESSLY ACKNOWLEDGE AND AGREE THAT USE OF THE DEVICE IS AT YOUR SOLE RISK AND THAT THE ENTIRE RISK AS TO SATISFACTORY QUALITY, PERFORMANCE AND ACCURACY IS WITH YOU. THE DEVICE AND ALL THIRD PARTY CONTENT AND SERVICES ARE PROVIDED "AS IS" WITHOUT WARRANTY OF ANY KIND, EITHER EXPRESS OR IMPLIED. SAMSUNG EXPRESSLY DISCLAIMS ALL WARRANTIES AND CONDITIONS WITH RESPECT TO THE DEVICE AND ANY CONTENT AND SERVICES, EITHER EXPRESS OR IMPLIED, INCLUDING BUT NOT LIMITED TO, WARRANTIES OF MERCHANTABILITY, OF SATISFACTORY QUALITY, FITNESS FOR A PARTICULAR PURPOSE, OF ACCURACY, OF QUIET ENJOYMENT, AND NON-INFRINGEMENT OF THIRD PARTY RIGHTS. SAMSUNG DOES NOT GUARANTEE THE ACCURACY, VALIDITY, TIMELINESS, LEGALITY, OR COMPLETENESS OF ANY CONTENT OR SERVICE MADE AVAILABLE THROUGH THIS DEVICE AND DOES NOT WARRANT THAT THE DEVICE, CONTENT OR SERVICES WILL MEET YOUR REQUIREMENTS, OR THAT OPERATION OF THE DEVICE OR SERVICES WILL BE UNINTERRUPTED OR ERROR-FREE. UNDER NO CIRCUMSTANCES, INCLUDING NEGLIGENCE, SHALL SAMSUNG BE LIABLE, WHETHER IN CONTRACT OR TORT, FOR ANY DIRECT, INDIRECT, INCIDENTAL, SPECIAL OR CONSEQUENTIAL DAMAGES, ATTORNEY FEES, EXPENSES, OR ANY OTHER DAMAGES ARISING OUT OF, OR IN CONNECTION WITH, ANY INFORMATION CONTAINED IN, OR AS A RESULT OF THE USE OF THE DEVICE, OR ANY CONTENT OR SERVICE ACCESSED BY YOU OR ANY THIRD PARTY, EVEN IF ADVISED OF THE POSSIBILITY OF SUCH DAMAGES.

Third party services may be changed, suspended, removed, terminated or interrupted, or access may be disabled at any time, without notice, and Samsung makes no representation or warranty that any content or service will remain available for any period of time. Content and services are transmitted by third parties by means of networks and transmission facilities over which Samsung has no control. Without limiting the generality of this disclaimer, Samsung expressly disclaims any responsibility or liability for any change, interruption, disabling, removal of or suspension of any content or service made available through this device. Samsung may impose limits on the use of or access to certain services or content, in any case and without notice or liability.

Samsung is neither responsible nor liable for customer service related to the content and services. Any question or request for service relating to the content or services should be made directly to the respective content and service providers.

Help Website

 Accessing steps may be changed in the future.

 It can be different links for special countries.

Country	Website
USA	www.samsung.com → consumer products → Television → medi@2.0 → Internet@TV
Canada	www.samsung.com → consumer products → TV → medi@2.0 → Internet@TV
	www.samsung.com → produits grand public → téléviseurs → medi@2.0 → Internet@TV
Mexico	www.samsung.com → productos de consumo → televisores → medi@2.0 → Internet@TV

AllShare

 MENU  → Application → Content View → AllShare → ENTER 

About AllShare

AllShare connects your TV and compatible Samsung mobile phones/ devices through a network. On your TV, you can view call arrivals, SMS messages and schedules set on your mobile phones. In addition, you can play media contents including videos, photos and music saved on your mobile phones or the other devices (such as your PC) by controlling them on the TV via the network. Additionally, you can use your TV for browsing web pages in your mobile phones.

 For more information, visit “www.samsung.com” or contact the Samsung call center. Mobile devices may need additional software installation. For details, refer to each device’s user’s guide.

Setting Up AllShare

Setup

- **Message (On / Off):** Enables or disables the message function (for call arrivals, SMS messages and schedules set on your mobile phones).
- **Media (On / Off):** Enables or disables the media function. When the media function is on, it plays videos, photos and music from a mobile phone or other device that supports **AllShare**.
- **ScreenShare (On / Off):** Enables or disables the ScreenShare function for using mobile phone as a remote control.
- **TV name:** Sets the TV name so you can find it easily on a mobile device.
 -  If you select **User Input**, you can type on the TV using the OSK (On Screen Keyboard).

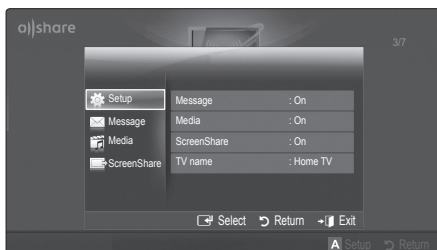

Message / Media / ScreenShare

Shows a list of mobile phones or connected devices which have been set up with this TV for using the **Message**, **Media**, or **ScreenShare** function.

 The **Media** function is available in all mobile devices which support **AllShare**.

- **Allowed / Denied:** Allows/Blocks the mobile phone.

- **Delete:** Deletes the mobile phone from the list.

 This function only deletes the name of the mobile from the list. If the deleted mobile device is turned on or tries to connect to the TV, it may appear on the list again.

Using the Message Function

Using this function, you view call arrivals, SMS messages and schedules set on the mobile phone through the alarm window while watching TV.

NOTE

- To disable the alarm window, set **Message** to **Off** in **Setup** of **AllShare**.
- If **OK** is selected, or if **OK** is not selected after the message has appeared three times, the message will be deleted. The message is not deleted from the mobile phone.
- The alarm window can be displayed while using some applications such as **Media Play** etc. To view the contents of a message, switch to TV viewing mode.
- When a message from an unknown mobile phone is displayed, select the mobile phone on the message menu in **AllShare** and select **Denied** to block the phone.

Message View

If a new SMS message arrives while you are watching TV, the alarm window appears. If you click the OK button, the contents of the message are displayed.

 You can configure the viewing settings for SMS messages on your mobile phones. For the procedures, refer to the mobile phone manual.

 Some types of characters may be displayed as blank or broken characters.



Advanced Features

Call Arrival Alarm

If a call arrives while you are watching TV, the alarm window appears.

Schedule Alarm

While you are watching TV, the alarm window appears to display the registered event.

-  You can configure viewing settings for schedule contents on your mobile phones. For the procedures, refer to the mobile phone manual.
-  Some special characters may be displayed as blank or broken characters.

Using the Media Function

An alarm window appears informing the user that the media contents (videos, photos, music) sent from a mobile phone will be displayed on your TV. The contents are played automatically 3 seconds after the alarm window appears. If you press the RETURN or EXIT button when the alarm window appears, the media contents are not played.

NOTE

- If the media function executes for the first time, the warning popup windows appears. Press the ENTER  button to select **Allow**, then you can use Media function on that device.

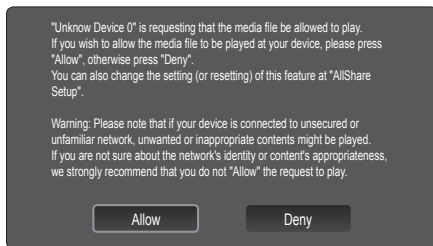

- To turn off the media contents transmission from the mobile phone, set **Media** to **Off** in the **AllShare** setup.
- Contents may not be played on your TV depending on their resolution and format.
- The ENTER  and ◀ / ▶ buttons may not work depending on the type of media content.
- Using the mobile device, you can control the media playing. For details, refer to each mobile's user's guide.
- When you want to play media contents from your PC, select the PC icon on the main display of **AllShare**. Then the TV's **Media Play** menu automatically changes. For more detail information, refer to "Media Play" (p. 32).

Using ScreenShare Function

Using ScreenShare, you can browse various web contents provided by the mobile phone. For example, the image below displays an access page for contents on a mobile. You can read the mobile's files and view the phone book and calendar on the TV. Also, in the phone book, you can make a call to another person, or send to SMS.

NOTE

- You must have ScreenShare installed on your Samsung Mobile phone/device to use this feature.
- Doc Viewer** can read files in doc format, but cannot modify them.
- The screen display may differ depending on the connected device.



Using your Samsung Phone to Operate Your TV

Before you can use this feature, you must connect to a Samsung mobile phone that supports ScreenShare functions. When operating the TV with your mobile phone, only the POWER, **-VOL+**, **∨ CH ^** and MUTE buttons are supported.

-  Even if you keep pressing down on a control button (channel or volume) on the mobile phone, the value will only go up or down by one unit.

Attaching the Blanking Bracket

When installing the TV onto a wall, attach the Blanking Bracket as shown.

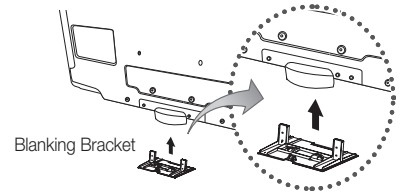

Preparing before installing Wall-Mount (46 ~ 55 inch TVs)

To install a wall-mount from another manufacturer, use the Holder-Ring.

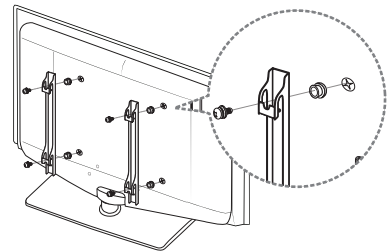

Installing the Wall Mount Kit

The wall mount kit (sold separately) allow you to mount the TV on the wall.

For detailed information on installing the wall mount, see the instructions provided with the wall mount. Contact a technician for assistance when installing the wall mount bracket. Samsung Electronics is not responsible for any damage to the product or injury to yourself or others if you elect to install the TV on your own.

Wall Mount Kit Specifications (VESA)

 The wall mount kit is not supplied, but sold separately.

Install your wall mount on a solid wall perpendicular to the floor. When attaching to other building materials, please contact your nearest dealer. If installed on a ceiling or slanted wall, it may fall and result in severe personal injury.

NOTE

- Standard dimensions for wall mount kits are shown in the table below.
- When purchasing our wall mount kit, a detailed installation manual and all parts necessary for assembly are provided.
- Do not use screws that do not comply with the VESA standard screw specifications.
- Do not use screws that are longer than the standard dimension or do not comply with the VESA standard screw specifications. Screws that are too long may cause damage to the inside of the TV set.
- For wall mounts that do not comply with the VESA standard screw specifications, the length of the screws may differ depending on the wall mount specifications.
- Do not fasten the screws too strongly; this may damage the product or cause the product to fall, leading to personal injury. Samsung is not liable for these kinds of accidents.
- Samsung is not liable for product damage or personal injury when a non-VESA or non-specified wall mount is used or the consumer fails to follow the product installation instructions.
- Do not mount the TV at more than a 15 degree tilt.
- Always use two people to mount the TV to a wall.

Other Information

Product Family	inches	VESA Spec. (A * B)	Standard Screw	Quantity
LCD-TV	19~22	75 X 75	M4	4
		100 X 100		
	23~29	200 X 100	M6	
	30~40	200 X 200		
	46~55	400 X 400	M8	
	57~65	600 X 400		
	70~80	800 X 400		
80~	1400 X 800			

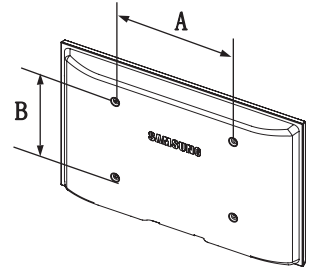

Do not install your Wall Mount Kit while your TV is turned on. It may result in personal injury due to electric shock.

Assembling the Cables

Enclose the cables in the Cable tie so that the cables are not visible through the transparent stand. Overly rigid or thick cables can damage input jacks over long term use.

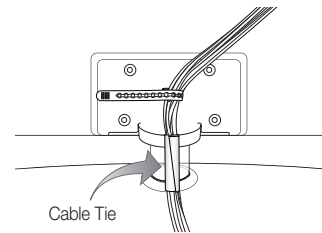

Anti-theft Kensington Lock

The Kensington Lock is not supplied by Samsung. It is a device used to physically fix the system when using it in a public place. The appearance and locking method may differ from the illustration depending on the manufacturer. Refer to the manual provided with the Kensington Lock for additional information on proper use.

Please find a “K” icon on the rear of the TV. A kensington slot is beside the “K” icon.

1. Insert the locking device into the Kensington slot ❶ on the LCD TV and turn it as shown ❷.

2. Connect the Kensington Lock cable ❸.

3. Fix the Kensington Lock to a desk or a heavy stationary object.

The locking device has to be purchased separately.

The location of the Kensington slot may be different depending on the TV model.

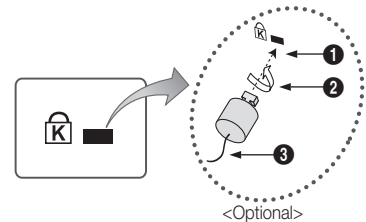

Securing the TV to the Wall



Caution: Pulling, pushing, or climbing on the TV may cause the TV to fall. In particular, ensure your children do not hang over or destabilize the TV; doing so may cause the TV to tip over, causing serious injuries or death. Follow all safety precautions provided on the included Safety Flyer. For added stability, install the anti-fall device for safety purposes, as follows.

Accessories



TV-Holder



Screw **1** (M6xL16)
(32 ~ 40 inch TVs)





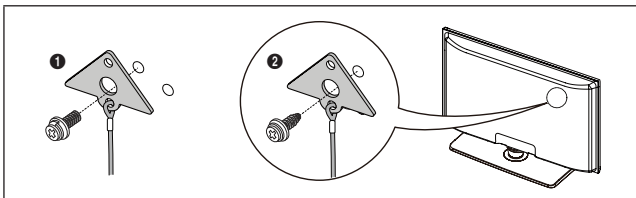

Screw **2** (M8xL19)
(46 ~ 55 inch TVs)

To prevent the TV from falling

1. Remove the screw attached to the back of your TV, then connect the Holder-TV **1** or **2** with the screw.
 Make sure to only use the supplied screw.



2. Firmly fasten the screw to the wall or cabinet where the TV is to be installed. Tie the TV-Holder attached to the TV and the screw fastened on the wall or cabinet so that the TV is fixed.
 -  Only the screw needed to attach the holder to the TV is supplied. The screw to attach the Holder to the wall or cabinet must be purchased separately. We recommend purchasing a size M4xL20 wood screw.
 -  Install the TV close to the wall so that it does not fall.
 -  When attaching the TV to the wall, tie the cord level with the ground or slanted downwards for safety purposes.
 -  Check the cord occasionally to make sure it is secure.
 -  Before moving the TV, separate the connected cord first.

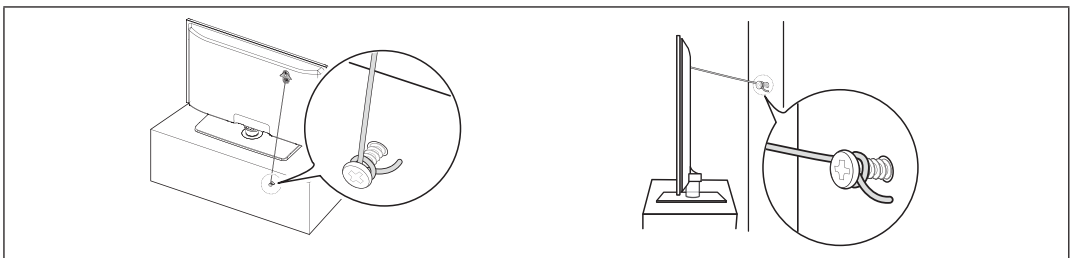

3. Verify all connections are properly secured. Periodically check connections for any sign of fatigue or failure. If you have any doubt about the security of your connections, contact a professional installer.

Other Information

Troubleshooting

If the TV seems to have a problem, first try this list of possible problems and solutions. If none of these troubleshooting tips apply, visit "www.samsung.com," then click on Support, or call Samsung customer service at 1-800-SAMSUNG.

Issues	Solutions and Explanations
Poor picture	First of all, please perform the Picture Test and confirm that your TV is properly displaying the test image. (go to MENU - Support - Self Diagnosis - Picture Test) (p. 25) If the test image is properly displayed, the poor picture may be caused by the source or signal.
The TV image does not look as good as it did in the store.	<ul style="list-style-type: none"> • If you have an analog cable/satellite box, upgrade to an HD digital set top box. Use HDMI or Component cables to deliver HD (high definition) picture quality. • Cable/Satellite subscribers: Try HD stations from the channel line up. • Antenna connection: Try HD stations after performing Auto program.  Many HD channels are up scaled from SD(Standard Definition) contents. • Adjust the Cable/Sat box video output resolution to 1080i or 720p.
The picture is distorted: macro block error, small block, dots, pixelization.	<ul style="list-style-type: none"> • Compression of video contents may cause picture distortion, especially in fast moving pictures such as sports and action movies. • Low signal level can cause picture distortion. This is not a TV problem.
Color is wrong or missing.	<ul style="list-style-type: none"> • If you're using Component connection, make sure the component cables are connected to the correct jacks. Incorrect or loose connections may cause color problems or a blank screen.
There is poor color or brightness.	<ul style="list-style-type: none"> • Adjust the Picture options in the TV menu. (go to Picture mode / Color / Brightness / Sharpness) (p. 16) • Adjust Energy Saving option in the TV menu. (go to MENU - Picture - Eco Solution - Energy Saving) (p. 16) • Try resetting the picture to view the default picture settings. (go to MENU - Picture - Picture Reset) (p. 19)
There is a dotted line on the edge of the screen.	<ul style="list-style-type: none"> • If the picture size is set to Screen Fit, change it to 16:9 (p. 18). • Change cable/satellite box resolution.
The picture is black and white.	<ul style="list-style-type: none"> • If you are using an AV composite input, connect the video cable (yellow) to the Green jack of component input 1 on the TV.
When changing channels, the picture freezes or is distorted or delayed.	<ul style="list-style-type: none"> • If connected to a cable box, please try to reset it. (reconnect the AC cord and wait until the cable box reboots. It may take up to 20 minutes) • Set the output resolution of the cable box to 1080i or 720p.
Sound Problem	First of all, please perform the Sound Test to confirm that your TV audio is properly operating. (go to MENU - Support - Self Diagnosis - Sound Test) (p. 25) If the audio is OK, the sound problem may be caused by the source or signal.
There is no sound or the sound is too low at maximum volume.	<ul style="list-style-type: none"> • Please check the volume of the device (Cable/Sat Box, DVD, Blu-ray etc) connected to your TV.
The picture is good but there is no sound.	<ul style="list-style-type: none"> • Set the Speaker Select option to TV Speaker in the Sound menu (p. 20). • If you are using an external device, make sure the audio cables are connected to the correct audio input jacks on the TV. • If you are using an external device, check the device's audio output option (ex. you may need to change your cable box's audio option to HDMI when you have a HDMI connected to your TV). • If you are using a DVI to HDMI cable, a separate audio cable is required. • If your TV has a headphone jack, make sure there is nothing plugged into it. • Reboot the connected device by reconnecting the device's power cable.
The speakers are making an inappropriate noise.	<ul style="list-style-type: none"> • Check cable connections. Make sure a video cable is not connected to an audio input. • For antenna or Cable connections, check the signal strength. Low signal level may cause sound distortion. • Perform the Sound Test as explained above.

Issues	Solutions and Explanations
No Picture, No Video	
The TV won't turn on.	<ul style="list-style-type: none"> • Make sure the AC power cord is securely plugged in to the wall outlet and the TV. • Make sure the wall outlet is working. • Try pressing the POWER button on the TV to make sure the problem is not the remote. If the TV turns on, refer to "Remote control does not work" below.
The TV turns off automatically.	<ul style="list-style-type: none"> • Ensure the Sleep Timer is set to Off in the Setup menu (p. 21). • If your PC is connected to the TV, check your PC power settings. • Make sure the AC power cord is plugged in securely to the wall outlet and the TV. • When watching TV from an antenna or cable connection, the TV will turn off after 10 - 15 minutes if there is no signal.
There is no picture/video.	<ul style="list-style-type: none"> • Check cable connections (remove and reconnect all cables connected to the TV and external devices). • Set your external device's (Cable/Sat Box, DVD, Blu-ray etc) video outputs to match the connections to the TV input. For example, if an external device's output is HDMI, it should be connected to an HDMI input on the TV. • Make sure your connected devices are powered on. • Be sure to select the TV's correct source by pressing the SOURCE button on the remote control. • Reboot the connected device by reconnecting the device's power cable.
RF(Cable/Antenna) Connection	
The TV is not receiving all channels.	<ul style="list-style-type: none"> • Make sure the coaxial cable is connected securely. • Please try Auto Program to add available channels to the channel list. Go to MENU - Channel - Auto Program then select Auto and make sure the correct Cable TV signal type is set in the menu. There are 3 options (STD, HRC and IRC) (p. 15). • Verify the Antenna is positioned correctly.
No Caption on digital channels.	<ul style="list-style-type: none"> • Check Caption Setup menu. Try changing Caption Mode Service1 to CC1 (p. 23). • Some channels may not have caption data.
The picture is distorted: macro block error, small block, dots, pixelization.	<ul style="list-style-type: none"> • Compression of video contents may cause picture distortion, especially with fast moving pictures such as sports and action movies. • A low signal can cause picture distortion. This is not a TV problem.
PC Connection	
A "Mode Not Supported" message appears.	<ul style="list-style-type: none"> • Set your PC's output resolution so it matches the resolutions supported by the TV (p. 12).
"PC" is always shown on the source list, even if a PC is not connected.	<ul style="list-style-type: none"> • This is normal; "PC" is always shown on the source list, regardless of whether a PC is connected.
The video is OK but there is no audio.	<ul style="list-style-type: none"> • If you are using an HDMI connection, check the audio output setting on your PC.
Network Connection	
The wireless network connection failed.	<ul style="list-style-type: none"> • The Samsung Wireless USB dongle is required to use a wireless network. • Make sure the Network Connection is set to Wireless (p. 28). • Make sure the TV is connected to a wireless IP sharer (router).
Software Upgrade over the network fails.	<ul style="list-style-type: none"> • Try network test in Setup menu (p. 23). • If you have latest SW version, SW upgrade will not proceed.
Others	
Purple/green rolling horizontal bars and buzzing noise from the TV speakers with Component cable connection.	<ul style="list-style-type: none"> • Remove the left and right audio connections from the set-top-box. If the buzzing stops, this indicates that the set-top-box has a grounding issue. Replace the Component video cables with an HDMI connection.
The picture won't display in full screen.	<ul style="list-style-type: none"> • HD channels will have black bars on either side of the screen when displaying up scaled SD (4:3) contents. • Black bars on the Top & Bottom will be shown on movies that have aspect ratios different from your TV. • Adjust the picture size options on your external device or TV to full screen.
The remote control does not work.	<ul style="list-style-type: none"> • Replace the remote control batteries with the poles (+/-) in the right direction. • Clean the sensor's transmission window on the remote. • Try pointing the remote directly at the TV from 5-6 feet away.
The cable/set top box remote control doesn't turn the TV on or off, or adjust the volume.	<ul style="list-style-type: none"> • Program the Cable/Set remote control to operate the TV. Refer to the Cable/Set user manual for the SAMSUNG TV code.

Other Information

Issues	Solutions and Explanations
A "Mode Not Supported" message appears.	<ul style="list-style-type: none"> Check the supported resolution of the TV, and adjust the external device's output resolution accordingly. Refer to the resolution settings on page 12 of this manual.
Caption on TV menu is greyed out.	<ul style="list-style-type: none"> Caption can not be selected in the TV menu when connected via HDMI or Component (p. 23). Caption must be activated on the external device (p. 23).
There is a plastic smell from the TV.	<ul style="list-style-type: none"> This smell is normal and will dissipate over time.
The TV Signal Information is unavailable in the Self Diagnostic Test menu.	<ul style="list-style-type: none"> This function is only available with digital channels from an Antenna / RF/Coax connection (p. 25).
The TV is tilted to the side.	<ul style="list-style-type: none"> Remove the base stand from the TV and reassemble it.
The channel menu is greyed out (unavailable).	<ul style="list-style-type: none"> The Channel menu is only available when the TV source is selected.
Your settings are lost after 30 minutes or every time the TV is turned off.	<ul style="list-style-type: none"> If the TV is in the Store Demo mode, it will reset audio and picture settings every 30 minutes. Change the settings from Store Demo mode to Home Use mode in the Plug & Play procedure. Press the SOURCE button to select TV mode, and go to MENU → Setup → Plug & Play → ENTER (p. 8).
You have intermittent loss of audio or video.	<ul style="list-style-type: none"> Check the cable connections and reconnect them. Loss of audio or video can be caused by using overly rigid or thick cables. Make sure the cables are flexible enough for long term use. If mounting the TV to a wall, we recommend using cables with 90 degree connectors.
The PIP menu is not available.	<ul style="list-style-type: none"> PIP functionality is only available when you are using a HDMI, PC or Component source.
You see small particles when you look closely at the edge of the frame of the TV.	<ul style="list-style-type: none"> This is part of the product's design and is not a defect.
POP (TV's internal banner ad) appears on the screen.	<ul style="list-style-type: none"> Select Home Use under Plug & Play mode. For details, refer to Plug & Play Feature (p. 8).

 This TFT LCD panel uses a panel consisting of sub pixels which require sophisticated technology to produce. However, there may be a few bright or dark pixels on the screen. These pixels will have no impact on the performance of the product.

License



Manufactured under license from Dolby Laboratories. Dolby and the double-D symbol are trademarks of Dolby Laboratories.



Manufactured under license under U.S. Patent #'s: 5,451,942; 5,956,674; 5,974,380; 5,978,762; 6,487,535 & other U.S. and worldwide patents issued & pending. DTS and the Symbol are registered trademarks. & DTS 2.0+ Digital Out and the DTS logos are trademarks of DTS, Inc. Product Includes software. © DTS, Inc. All Rights Reserved.



DivX Certified to play DivX video up to HD 1080p, including premium content.

ABOUT DIVX VIDEO: DivX® is a digital video format created by DivX, Inc. This is an official DivX Certified device that plays DivX video. Visit www.divx.com for more information and software tools to convert your files into DivX video.

ABOUT DIVX VIDEO-ON-DEMAND: This DivX Certified® device must be registered in order to play DivX Video-on-Demand (VOD) content.

To generate the registration code, locate the DivX VOD section in the device setup menu.

Go to vod.divx.com with this code to complete the registration process and learn more about DivX VOD. Pat. 7,295,673; 7,460,688; 7,519,274

Open Source License Notice

In the case of using open source software, Open Source Licenses are available on the product menu.

Specifications

Panel native	1920 x 1080 @ 60 Hz	
Environmental Considerations	50°F to 104°F (10°C to 40°C)	
Operating Temperature	10% to 80%, non-condensing	
Operating Humidity	-4°F to 113°F (-20°C to 45°C)	
Storage Temperature	5% to 95%, non-condensing	
Storage Humidity	-20° ~ 20°	
Stand Swivel (Left / Right)	-20° ~ 20°	
Model Name	LN32C650	LN40C650
Screen Size (Diagonal)	32 inches (31.5 inches measured diagonally)	40 inches (40.0 inches measured diagonally)
Sound (Output)	10 W X 2	
Dimensions (WxDxH)	10 W X 2	
Body	31.1 X 3.1 X 20.1 inches (789.2 X 77.8 X 509.9 mm)	38.4 X 3.2 X 24.2 inches (976.2 X 80.4 X 614.9 mm)
With stand	31.1 X 9.4 X 21.9 inches (789.2 X 240.0 X 555.9 mm)	38.4 X 10.0 X 26.0 inches (976.2 X 255.0 X 659.3 mm)
Weight	20.3 lbs (9.2 kg)	
Without Stand	26.0 lbs (11.9 kg)	
With Stand	31.5 lbs (14.3 kg)	
Without Stand	39.0 lbs (17.7 kg)	
Model Name	LN46C650	LN55C650
Screen Size (Diagonal)	46 inches (46.0 inches measured diagonally)	55 inches (55.0 inches measured diagonally)
Sound (Output)	10 W X 2	
Sound (Output)	15 W X 2	
Dimensions (WxDxH)	10 W X 2	
Body	43.6 X 3.2 X 27.2 inches (1108.6 X 80.3 X 689.7 mm)	51.2 X 3.4 X 31.5 inches (1301.6 X 85.3 X 801.2 mm)
With stand	43.6 X 10.8 X 28.9 inches (1108.6 X 275.0 X 734.5 mm)	51.2 X 12.0 X 33.3 inches (1301.6 X 305.0 X 845.3 mm)
Weight	39.9 lbs (18.1 kg)	
Without Stand	48.3 lbs (21.9 kg)	
With Stand	61.9 lbs (28.1 kg)	
Without Stand	72.1 lbs (32.7 kg)	

 Design and specifications are subject to change without prior notice.

 This device is a Class B digital apparatus.

 For information about power supply, and more about power consumption, refer to the label attached to the product.

Other Information

Dimensions

■ Front view / Side view`

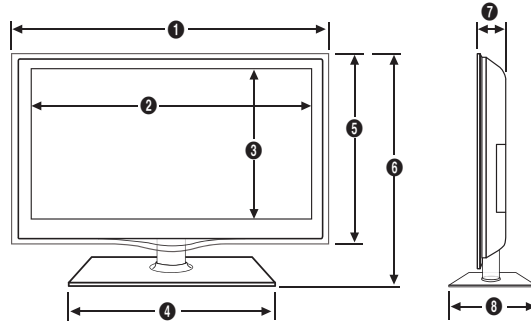

(Unit: inches)

Model name	1	2	3	4	5	6	7	8
LN32C650	31.1	27.5	15.5	17.5	20.1	21.9	3.1	9.4
LN40C650	38.4	34.9	19.7	20.5	24.2	26.0	3.2	10.0
LN46C650	43.6	40.1	22.6	21.7	27.2	28.9	3.2	10.8
LN55C650	51.2	47.7	26.9	22.8	31.5	33.3	3.4	12.0

■ Jack panel detail / Rear view

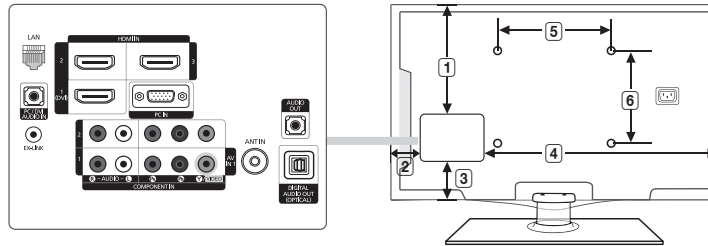

(Unit: inches)

Model name	1	2	3	4	5	6
LN32C650	9.3	2.0	3.8	20.9	7.9	7.9
LN40C650	13.2	2.7	4.0	27.6	7.9	7.9
LN46C650	16.1	3.7	4.0	31.8	15.7	15.7
LN55C650	20.5	3.8	4.1	39.3	15.7	15.7

NOTE: All drawings are not necessarily to scale. Some dimensions are subject to change without prior notice. Refer to the dimensions prior to performing installation of your TV. Not responsible for typographical or printed errors.

© 2010 Samsung Electronics America, Inc

A

AllShare	49
Amplify	19
Antenna	14
Anynet+	39
AUDIO OUT	11
Auto Adjustment	19
Auto Volume	20

B

Background Music	38
Balance L/R	19
Basic View	37
Batteries	7
Black Tone	17
Blanking Bracket	51
Brightness	16

C

Cable Tie	4, 52
Change PIN	22
Channel Menu	14
Clock	20
Color Tone	18
Component	10
Connecting to a PC	12
Connecting to an Audio Device	11

D

DIGITAL AUDIO OUT	11, 39
DivX® VOD	38
D-sub	12
Dynamic	16
Dynamic Contrast	17

E

Eco Sensor	16
Edit Name	13
Editing Channels	15
Energy Saving	16
Equalizer	19
External Speaker	20

F

FAV.CH button	7, 14
Film Mode	18
Fine Tune	16
Flesh Tone	17
Frequency	12

H

HDMI	9, 39
Home Theater	11, 39

I

Installation Space	2
Internet@TV	42

L

Language	23
License	56

M

Media Play	32
Melody	24
Memorizing Channels	14
Menu Transparency	24
Mono	20
Music	36

N

Navigate	13
Network Connection	26
Network Setup	27

O

ON/OFF button	7
Optimal resolution	12

P

Password	43
Photos	37
Picture Size	18, 38
PIP (Picture in Picture)	24
Plug & Play	8
Power Indicator	5

R

Receiver	41
Recording	40
Remote Control	7
Repeat Mode	38
RGB Only Mode	17
Rotate	38

S

Select All	15
Self Diagnosis	25
Sharpness	16
Signal Information	25
Sleep Timer	21
Slide Show	37
Software Upgrade	25
Source List	13
Speaker Select	20
Specifications	57
Standby mode	5
Symbol	3

T

Timer	21
Title	37
Tools	3
Troubleshooting	54
TV Speaker	20

U

USB Drive	25, 32
-----------	--------

V

Video Formats	35
Videos	34
Volume	5

W

Wall Mount	51
Warm	18
White Balance	18
Widget	47

***This page is intentionally
left blank.***